



Supplemental Price Lists
Dated November 1, 2016

Swish Casegoods

Bourne Seating and Casegoods

Reef Tables

Strata Reception

Table of Contents

Environmental Mission	2
Terms and Conditions	3
Order Check List	4
Textiles	5
Specification and Planning Guide	6-39
Product Specifications	40
Product Overview	41-48
Typicals	49-54
Drawer Dimensions	55-61
Pre-Configured	63-75
Worksurface	76-124
Modular Executive Height Storage	125-132
Modular Bench Height Storage	133-138
Tall Storage	139-148
Above Surface Storage	149-165
Accessories	166-195
Collaborate	196-213
Power and Data	214-217
Fabric Grading	218-222

Environmental Mission

Our vision and goal is a sustaining supplier, manufacturer and customer for the long term protection and preservation of our environment for future generations.

MISSION

To achieve this vision, we are dedicated to ensuring the health and wellbeing of all of our partners, reducing negative impact on the environment, and maintaining price structure by increasing efficiencies and reducing consumption.

The Jasper Group family of brands, including JSI, is an international manufacturer that has been an environmentally conscious organization for more than 80 years.

We are proud to use wood as our primary sustainable material resource and all corporate policies and procedures support the efforts to “recover, recycle, reuse, repurpose, reduce, refuse, and re-engineer” In doing this, we are committed to the conservation of the environment and its natural resources as well as encouraging our suppliers and customers to do the same. A goal of a “Sustainable Partnership” supplier, manufacturer and customer, is essential for the long term protection preservation and sustainability of our environment for future generations.

LOCATION

Our manufacturing facilities are located in Southern Indiana. With our diverse product offering and manufacturing capabilities, we provide a single source for all of your project needs allowing you to conserve our fossil fuels and reduce greenhouse gases.

PACKAGING

We place emphasis on the minimal use of disposable packaging while still providing adequate protection to the finished product. Our corrugated packaging is recyclable, reusable, and up to 100% recycled content. We reuse or recycle more than 125 tons of corrugated material annually.

REGULATORY

All of our manufacturing facilities are in compliance with applicable OSHA regulations and meet or exceed all applicable DEM and EPA regulations for air emissions, storm water and hazardous waste disposal.

MANUFACTURING FACILITIES

Our manufacturing facilities are geared toward eco-efficiency and are encouraged to continually improve and conserve. Solid wood not used in the direct manufacturing process is recovered for the operation of our dry kilns, thus reducing greenhouse gases, the use of fossil fuels, and the burden of waste placed on landfills. Composite panels not used in the direct manufacturing process are ground and sold for use as animal bedding. In addition to other energy savings techniques, our manufacturing facilities use high efficient lighting, make use of power factor capacitors, and encourage all to conserve and reduce energy consumption and water usage. Condensation pumps are used to aid in water conservation as well as extending boiler life.

MANUFACTURING PROCESSES

Our finish processes utilize efficient spray guns and proper spray techniques to reduce wasted material. Excess finish material, solvents, and waste are recycled. Many of the assembly processes use water based glues that contain no hazardous ingredients.

TEXTILES

Many of our fabric options utilize up to 100% recycled content. Our leather alternative program includes selections that contain no toxic materials, plasticizers, heavy metals, or formaldehyde and have a 100% biodegradable back cloth. Some of the available panel fabric used, if discarded is a biological nutrient for the soil. Most of the components (foam, batting, and polycord) used in upholstered products are recyclable and contain various percentages of recycled content. Excess fabrics and leathers not utilized in the upholstery process go to recyclers and local charities for additional use.

WOOD

Wood is the most diverse, most process friendly, and most widely utilized natural resource in mankind's history. No other natural resource can match the environmental advantages of wood, including being renewable, recyclable, natural, carbon negative, and biodegradable. Utilizing the sun's energy, trees grow and remove carbon dioxide from the air while giving off oxygen to benefit the entire planet. Approximately 49% of wood's dry weight is carbon and harvesting mature trees in a sustainable forest, which has slowed in the absorption of carbon dioxide, allows the photosynthetic cycle to continue at full optimization and allow for the carbon to remain sequestered. We are proud to use wood as our primary “sustainable” renewable resource.

WOOD OPTIONS

Many environmentally friendly solid wood and engineered wood options are available for quote, including: Lyptus®, Plyboo®, reclaimed woods, agricultural and post-consumer waste fiber products, soy-based resin bio-composites, etc.

INDOOR AIR QUALITY

Our goal is to reduce the impact our products will have on the indoor air quality. We practice the latest technologies and utilize a third party to assure we meet this goal. GreenGuard, one of the leaders in IAQ certification, continues to certify our product offering, awarding us the UL2818 - GreenGuard Indoor Air Quality standard.

PARTNERSHIPS

BIFMA

Business and Institutional Furniture Manufacturer Association

USGBC

United States Green Building Council

IIDA

International Interior Design Association

FSC

Forest Stewardship Council

GreenGuard

Terms and Conditions

Casegoods Warranty

JSI warrants to the original purchaser that each piece of furniture will be free from defects in workmanship given normal use for a period of fifteen (15) years of single shift service. Drawer suspensions carry a lifetime warranty. Fabric manufacturer's warranty will apply. Electrical items not manufactured by JSI are covered for a period of one (1) year. JSI will, at its option, repair or replace any defective merchandise within the terms of the warranty.

JSI makes no expressed or implied warranties to any product and, in particular, makes no warranty of merchantability fitness for any particular purpose.

This warranty does not cover:

- Natural variations in color, texture of wood, and covering materials over which JSI has no control.
- Damage created by bottom loading file drawers. File drawers are manufactured for hanging folders only.
- Normal wear, color fastness, shrinkage, wrinkling, stretching of leather, and textiles.
- Damage caused by transportation or installation companies.
- Damage created by any accident, user modification, misuse of product or neglect of product care.
- Damage resulting from extreme climate conditions.

Swish Order Analyst

Jasper Group has a Swish order analyst on staff that will review customer purchase orders against their submitted drawings to help us ensure more accurate orders. If a drawing is not submitted, the end user application will be less apparent and omissions of required products for the planned furniture configuration may not be caught prior to delivery of the order. Jasper Group will not be liable for costs associated with delays of components that were not called out on the order acknowledgement.

Samples

Samples of Swish standard laminates and acrylics are available upon request. To place an order, select the literature section on the resources tab at www.jsifurniture.com or contact your JSI sales rep or contact Customer Service at 800-457-4511.

Orders

Please reference the "To order, specify" sections when submitting an order. Indicate ship to address if different from bill to address. All orders should be mailed, faxed or emailed to:

JSI
225 Clay Street
Jasper, IN 47546
Fax: 812-482-1548
Email: orders@jaspergroup.us.com

Detailed specification sheets are available for each series, consult the Customer Service Department at 800-457-4511 or our JSI website. JSI reserves the right to make changes in dimensions, style, or specifications if we believe these changes will improve an item's quality or appearance.

Product Modifications

We willingly accept customers' modifications to standard products. If there is a modification you desire please contact the Customer Service Department for special quotes, minimum quantities and reasonable lead times.

Order Changes

All changes to an order must be made in writing and are subject to our ability to conform. Administrative and/or labor charges may be incurred by the dealer depending upon the production stage of the order. Once final production has begun, no changes can be accepted.

Acknowledgements

All orders will be acknowledged promptly showing how the order was entered, shipping time, and other pertinent information. Please examine this acknowledgment carefully and notify us immediately of any discrepancies. If a firm ship date is necessary, please let us know and we will do all we can

to meet your request. Acknowledged ship dates are contingent upon adverse conditions, however, every effort is made to ship as acknowledged.

Cancellations

All cancellations must be made in writing. Administrative and/or labor charges may be incurred by the dealer depending upon the production stage of the order. Orders cannot be canceled after the finishing process has begun without incurring substantial restocking charges. Cancellations cannot be accepted once final production has begun.

Pricing

All prices shown are list and include delivery to one destination. Prices are subject to change without notice. Possession of this price list does not constitute an offer to sell. Orders can be received only from authorized JSI dealers.

Delivery

Prepaid freight to the 48 contiguous states. All other shipments prepaid to port of exit **ONLY**. JSI reserves the right to select the appropriate carrier. Special requests including, but not limited to, inside delivery and installation are not included in prices shown. Any charges arising from failure to meet shipment, rerouting while in transit, or carrier storage charges are the responsibility of the customer. Orders of less than \$1,000 net will be assessed a handling charge of \$75 net per order (waived for items shipped via UPS).

Freight Damage

All shipments are delivered to the carrier in good condition and our liability ceases thereafter. **If shipment arrives short or damaged, you should file claim immediately with the carrier.** In the event of concealed damage, notify carrier and request an immediate inspection. Keep all cartons and packing material. Failure to file claim within 15 days after receipt of merchandise constitutes acceptance and a waiver of any such claims. Please inspect merchandise immediately upon receipt, otherwise there is no recourse.

Returns and Repairs

No merchandise may be returned to JSI without a signed Return Goods Authorization form (RGA) issued by our Customer Service Department. Liability for defective merchandise shall be limited to replacement or repair. We will not issue credit allowances for any repairs without our prior consent. Under no circumstances can we accept COD (Cash On Delivery) returns. Any such shipment will be refused.

Replacement Parts

Prices for replacement parts can be obtained by calling our Customer Service Department. Please have the model number available when ordering replacement parts.

Order Check List

JSI products are manufactured to order and provide a multitude of options to address your individual customer needs. As you process your order do not forget to include all the necessary information to allow the order entry process to be completed. Please see the order check list at the beginning of each section as well as the specification and planning guide on pages 6-39.

JSI Customer Service edits every order for complete information. If details are not included with the purchase order, Customer Service will contact you to answer these questions. If information is not completed in a timely manner it will delay the entry process and could effect your product delivery date. To avoid delay in order entry and potential delay in delivery of your order, please double check the line items to insure all selections have been completed.

To ensure complete JSI details on your purchase order, electronic catalogs and specification tools have been developed to aid in the process. These electronic tools include:

20-20 GIZA Studio and **20-20 CAP Studio** software offers state-of-the-art design, specification, photo-realistic rendering and three-dimensional visualization capabilities for configurable products in the commercial interior design markets. 20-20 GIZA Studio and 20-20 CAP Studio are available for all JSI Casegood and Seating products, in 2D and 3D graphics and the Specifier Catalog.

ProjectMatrix, Inc offers a full software solution for the contract furniture industry. Their software can help you create space plans to specifications for ease of specifying our JSI Casegood and Seating product lines.

Our JSI web site www.jsifurniture.com provides many tools to assist in the design and order selection. Included in the site are downloadable images, typicals, product symbols, brochures, contact information, price lists, sales representative locations, warranty and environmental information.

Care and Maintenance:

Laminate Surfaces and PVC Edges

Clean with a mild soap solution and rinse with clean water. Wipe the entire surface and follow with a clean, dry soft cloth.

Aluminum and Powder Coat Metals

Clean with a mild soap solution and rinse with clean, clear water. Wipe the entire surface and follow with a clean, dry cloth to buff dry.

Textiles

Textile Programs

JSI is proud to partner with Maharam, Momentum, Ultrafabrics and Wollsdorf Leather. Please refer to the respective pages in this pricer for each of these partners. Scan the QR codes on the back of the swatch card for latest grades and other information.

Textile Grade-In Programs

For the convenience of our specifiers, we have graded in the following suppliers:

Arc Com	Pallas Textiles
Designtex	Stinson
Maharam	Ultrafabrics
Mayer	Wollsdorf Leather
Momentum	

Please contact Customer Service for pricing grades on textiles and leathers not listed.

Indicate on purchase order if JSI is to order the fabric.

Grades and availability of fabric are subject to change without notice. Changes could include but are not limited to price increase, discontinued patterns, discontinued colors, etc. See jsifurniture.com for up to date information.

Many textiles have repeats and the additional yardage required has been factored in for textiles ordered through the JSI Carded and Grade-In Programs. We reserve the right not to match textiles with a horizontal or vertical repeat greater than 17". Additional charges may apply for textile being applied with special instructions.

Some fabric thickness may cause issue with proper upholstering of tackable wall panels or upholstery privacy screens. Please contact Customer Service, with concerns on the fabric thickness for these items.

Fire Retardancy

All JSI products are manufactured to comply with California Bureau of Home Furnishings Technical Bulletin 117 as a minimum standard. Compliance with more stringent codes requires special manufacturing considerations and upcharges.

California Technical Bulletin 133

JSI uses a barrier material between the foam cushioning and the upholstery cover in order to comply with California TB 133. The standard upcharge on products specified to comply with TB 133 is \$58 list per yard of fabric.

Some product designs and fabrics cannot be combined to comply with California TB 133 (CAL 133). Because of this, we reserve the right to reject any request for an upholstery cover, including COM, or product style that we feel may compromise the integrity or safety of a product specified to comply with CAL 133. JSI has tested representative styles for compliance of CAL 133.

Contact Customer Service for a quotation if you require laboratory certification that a specific product and upholstery combination will pass CAL 133. Quotation will include testing, video and transportation charges plus the list cost of sample. (Allow an additional six weeks over the standard lead time for testing. For products not requiring certification, our standard lead time will apply.)

COL

COL pricing is listed under column D in the price list. Customer's own leather requirements are based on an average hide of 50 square feet. Please consult Customer Service for requirements on any other sizes.

All square footage requirements are based on useable footage. The shape of the hide and the useable footage may make it necessary for us to request additional leather.

COM

COM pricing is listed under column B in the price list. All yardage requirements listed in the price list are based upon 54" plain non-directional material. Additional yardage will be required for repeats or fabric less than 54" wide, contact Customer Service for yardage requirements.

All stripes will be applied vertically unless specified otherwise. Patterned fabrics will be applied at our discretion unless special instructions are included with the order.

We cannot assume responsibility for the receipt of defective COM or for the tailoring quality of said fabric. Some fabrics, due to their bulkiness or thinness may not tailor well.

All COM orders must include the following:

- Vendor's name, pattern name and color.
- Sample of the fabric attached to order.
- Model numbers of items for fabric application.
- Special application instructions. (e.g., all stripes will be applied front to back unless specified otherwise)
- Customer and purchase order number.

Ship prepaid COM material to:

JSI
Attn: COM Dept.
932 Mill Street
Jasper, IN 47546

All COM orders will ship at standard lead time from receipt of COM except for orders requiring special custom matched finishes.

Application of COM Fabric

COM fabric is cut "up the roll" for lounge units, mobile pedestals and seat cushions and "railroaded" for tackboards unless otherwise specified by customer.

Railroaded Up the Roll

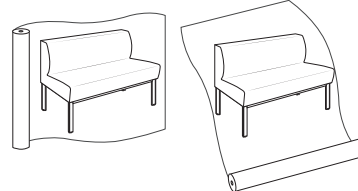

for people who work with people!

step
1

workspace
(page 8)

Select your workspace from various shapes and sizes to accommodate your work space and style.

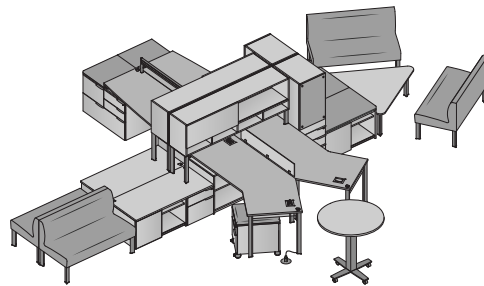

step
2

undersurface storage & supports
(page 12)

Choose your undersurface storage units to maximize storage space.

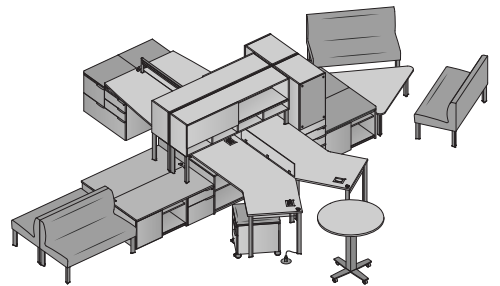

step
5

accessories
(page 22)

Choose accessories to divide space and increase functionality.

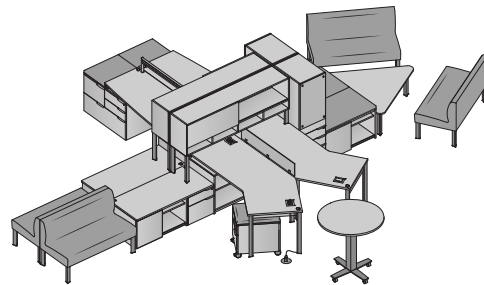

step
6

collaborate
(page 24)

Complete your setting by adding integrated collaboration components.

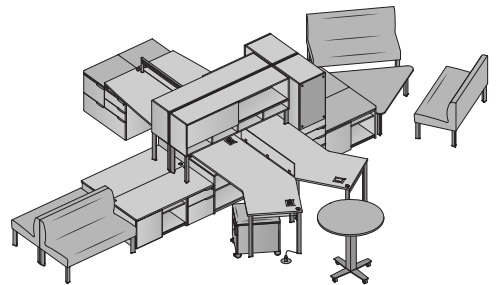

www.swish.jsifurniture.com

Call 800 457 4511 to discuss your project with a JSI Swish expert!

SWISH

step
3

tall storage
(page 16)

Select tall storage units for worksurface supports or as standalone storage.

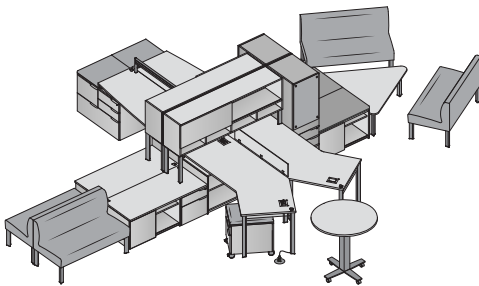

step
4

above surface storage & supports
(page 18)

Choose your above surface units to put storage where you need it.

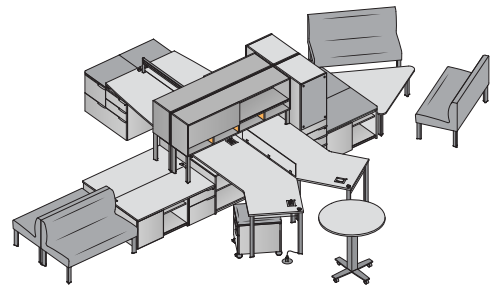

step
7

electrical
(page 26)

Continue your power specifications from the worksurface throughout the entire work space.

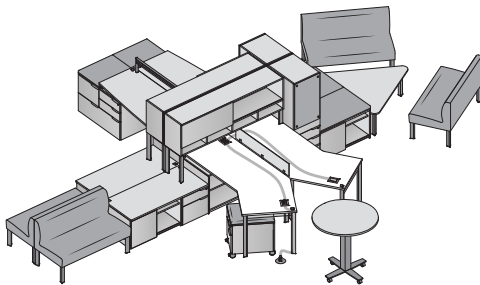

more
!

pre-configured units
(page 28)

Jump-start your space with pre-configured units.

idea starters
(page 30)

Need help getting started? Check out how Swish can outfit different work styles.

surface materials
(page 38)

The mixed material platform integrates warm and cool tones with organic beauty.

This specification guide will help you understand the simple components of Swish.

Use these step by step instructions to build Swish for your specific work style, space and budget.

step

1

Specifying Swish Step One

worksurface (tops)

To begin your Swish specification, you will need to select a worksurface...

1-A Choose a top shape.

1-B Specify a top size.

1-C Choose your laminate.

- Worksurfaces can be specified in 7 solid laminates and 11 woodgrain laminates. For additional surface materials information, see page 38.
- Swish worksurfaces feature a coordinating eased PVC edge on all four sides.
- To order conference tables without any grommets review the Collaborate section, see page 24.

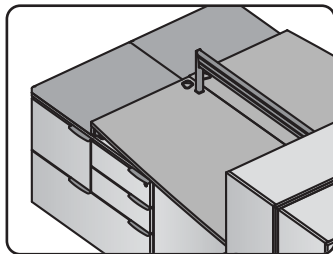

supports

Top depth must match the depth of the pedestal.
When worksurface grommets are inset, subtract 6" from pedestal depth.

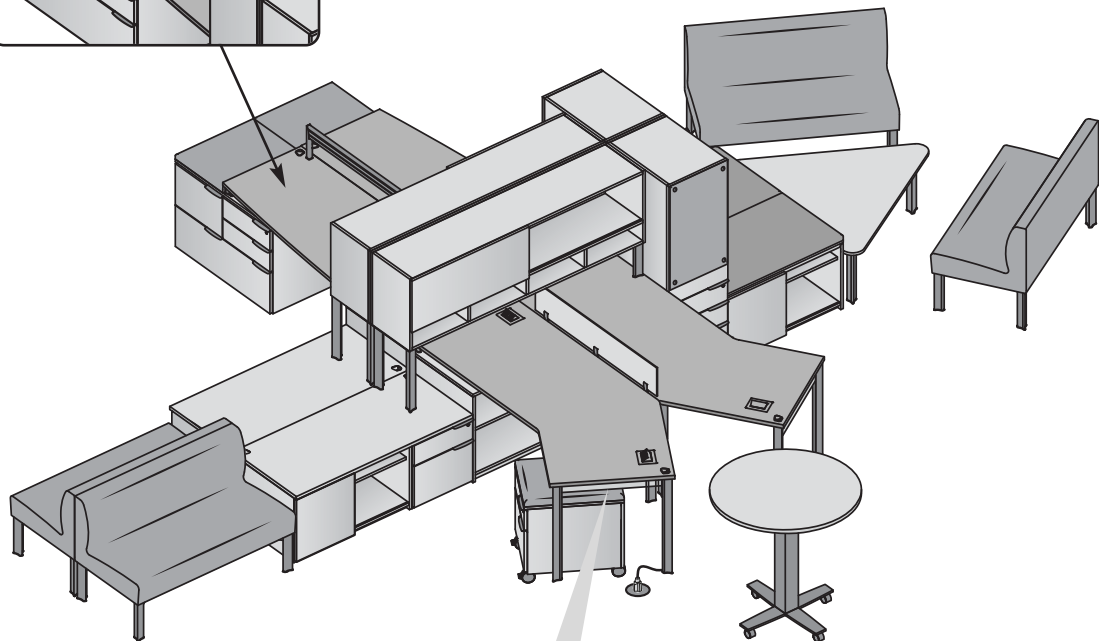

TIP! The removable acrylic plenum hides undersurface cords and creates a decorative accent.

www.swish.jsifurniture.com

Call 800 457 4511 to discuss your project with a JSI Swish expert!

TIP! Rectangle tops can be specified with grommets inset 6" from the approach side.



rectangle

Basic top shape with endless possibilities. Perfect for benching, long linked runs and worksurfaces.

worksurface

36"d x 96"w	30"d x 96"w	24"d x 96"w	18"d x 96"w
36"d x 90"w	30"d x 90"w	24"d x 90"w	18"d x 90"w
36"d x 84"w	30"d x 84"w	24"d x 84"w	18"d x 84"w
36"d x 78"w	30"d x 78"w	24"d x 78"w	18"d x 78"w
36"d x 72"w	30"d x 72"w	24"d x 72"w	18"d x 72"w
36"d x 66"w	30"d x 66"w	24"d x 66"w	18"d x 66"w
36"d x 60"w	30"d x 60"w	24"d x 60"w	18"d x 60"w
		24"d x 54"w	18"d x 54"w
		24"d x 48"w	18"d x 48"w
		24"d x 42"w	18"d x 42"w
		24"d x 36"w	18"d x 36"w
		24"d x 30"w	18"d x 30"w
		24"d x 18"w	18"d x 18"w

TIP! Fin tops can be specified with arc on user side or approach side. Can be specified with grommets inset 6" on the straight approach side.



fin

Unique shape that adds additional worksurface space to each station while adding design flair.

worksurface

36"d x 84"w	30"d x 84"w
36"d x 78"w	30"d x 78"w
36"d x 72"w	30"d x 72"w
36"d x 66"w	30"d x 66"w
24"d x 84"w	
24"d x 78"w	
24"d x 72"w	
24"d x 66"w	

TIP! Can be specified with nook cutout to be on left portion or right portion of user side. Can also be specified with grommets inset 6" from the approach side.



nook

Allows user to nestle closer to storage and creates smaller footprint options without sacrificing workspace. Pedestal restrictions apply, see page 14.

worksurface

36"d x 84"w	30"d x 84"w
36"d x 78"w	30"d x 78"w
36"d x 72"w	30"d x 72"w

TIP! When used as a bridge, the 36"w and 30"w units can only be used with corner worksurfaces.



boomerang

Integrate adjustable height tables and seating into a run of stations to create handy meeting spaces.

worksurface

30"d x 84"w
24"d x 84"w

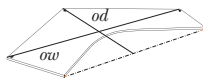

120°

Team up with your neighbor and interact with ease.

worksurface

18"d x 39 1/8"ow x 83 1/8"od
18"d x 36 1/8"ow x 72 3/4"od
18"d x 33 1/8"ow x 62 3/8"od
24"d x 44 5/16"ow x 83 1/8"od
24"d x 41 5/16"ow x 72 3/4"od
24"d x 38 5/16"ow x 62 3/8"od

Grain direction runs parallel to the ow. Pedestal restrictions apply, see page 14.

ow = overall width
od = overall depth

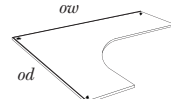

corner

Create cockpit style areas with extra worksurface space and multiple working positions for ergonomic flexibility. Depth at ends = 18", 24", 30", 36"

worksurface

60"od x 78"ow	54"od x 78"ow
60"od x 72"ow	54"od x 72"ow
60"od x 66"ow	54"od x 66"ow
60"od x 60"ow	54"od x 60"ow
48"od x 72"ow	
48"od x 66"ow	
48"od x 60"ow	

Grain direction runs parallel to the ow. Pedestal restrictions apply, see page 14.

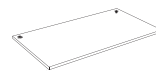

return / bridge

Create L and U units by adding bridges and return to main worksurfaces.

worksurface

24"d x 60"w	18"d x 60"w
24"d x 54"w	18"d x 54"w
24"d x 48"w	18"d x 48"w
24"d x 42"w	18"d x 42"w
24"d x 36"w	18"d x 36"w
24"d x 30"w	18"d x 30"w

Bridges ship with 2 flat brackets. Returns ship with 1 flat bracket. Grain direction runs front to back, which will match primary worksurface.

Worksurfaces include: wire management channel, stress bar, plenum for approach side and end, and plenum retainers.

Pre-configured units are available...

We've selected basic shapes, sizes and settings to help you order Swish even easier, see page 28.

step
1

Specifying Swish Step One (continued)

worksurface (electrical)

Now, select your worksurface electrical options...

- 1-D Determine if above surface electrical is needed.
- 1-E Choose cutout locations.
- 1-F Determine if undersurface electrical is needed.
- 1-G Specify undersurface power, either single or dual circuit.

► Standard locations of cutouts, to accommodate EC10 and EC11 power/data units, are available at no charge.

Above surface electrical cutout locations.

To add quick plug and play power/data units, be sure to specify your worksurface with an electrical cutout.

TIP! The EC10/EC11 grommet cutouts for 18" deep worksurfaces will run perpendicular to user.



rectangle

EC10/EC11 grommet cutout locations are available left and right.



fin

EC10/EC11 grommet cutout locations are available left and right.

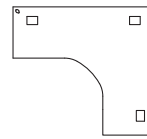

corner

EC10/EC11 grommet cutout locations are available left, center and right.

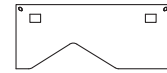

nook

EC10/EC11 grommet cutout locations are available left and right.

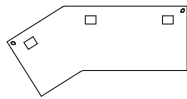

boomerang

EC10/EC11 grommet cutout locations are available left, center and right.

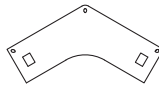

120°

EC10/EC11 grommet cutout locations are available left and right.

TIP! For additional field installed grommets see the Electrical section, see page 27.

TIP! Grommet cutouts to accommodate EC10 and EC11 power/data units can be placed in left or right locations, as well as center on some units. To specify the cutout location, use the number one (1) digit to indicate the cutout



location 001



locations 101

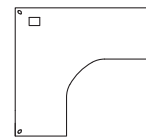

location 010

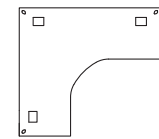

locations 111

NOTE! EC10/EC11 POWER/DATA UNITS MUST BE ORDERED SEPARATELY.

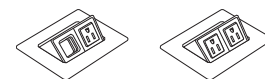

www.swish.jsifurniture.com

Call 800 457 4511 to discuss your project with a JSI Swish expert!

Undersurface electrical.

*If you would like to power your workstation, you will need to specify the worksurface with the electrical option.
-When using a dual circuit system, the power infeed must be hardwired.*

Choose from two power options: Single Circuit or Dual Circuit.

single circuit:

*One circuit throughout the entire station.
(specify P1 only)*

dual circuit:

*Alternate circuit 1 and circuit 2 worksurfaces.
(specify P1 or P2)
or...
Mix circuit 1 and circuit 2 receptacles within one surface.
(specify PM)*

TIP! Worksurfaces that are specified with undersurface electrical, will ship with the electrical components installed.

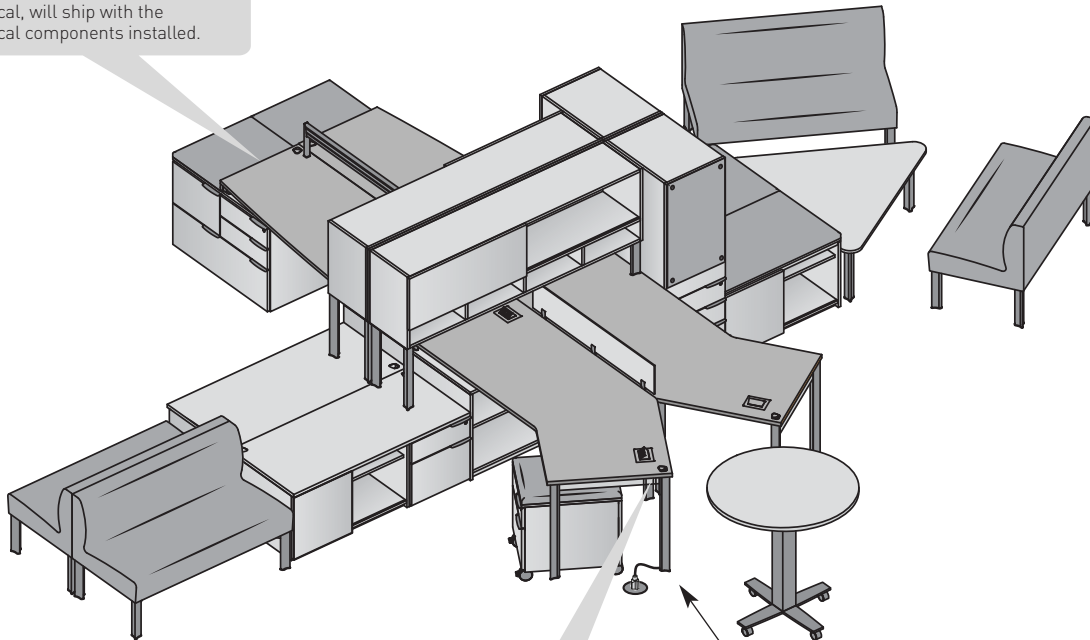

TIP! Thoughtfully placed grommets and the open leg design with cord cover will conceal the electrical conduit and cords as they travel throughout the workspace.

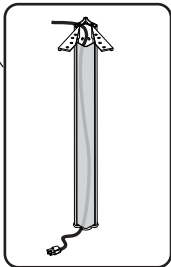

Additional electrical units...

To continue power from the worksurface through undersurface storage and to the power source, additional electrical components must be specified in the Electrical section, see page 26. Power infeed jumpers will carry power from the power source to the workstation.

step

2

Specifying Swish Step Two

undersurface storage & supports

Select the undersurface storage components that best suit your work mode...

- 2-A Determine undersurface storage height.
 - 2-B Choose a style.
 - 2-C Determine width and depth.
 - 2-D Specify a laminate.
- Storage can be specified in 7 solid laminates and 11 woodgrain laminates. For additional surface materials information, see page 38.

Select undersurface storage.

Choose executive height units to create airy floating tops. Height from floor to worksurface is 29³/₈".

Choose bench height units to achieve layers and additional seating. Height from floor to modular top is 20".

TIP! Cushion tops can be added to executive height or bench height storage to create seating. See the Collaborate section, page 24.

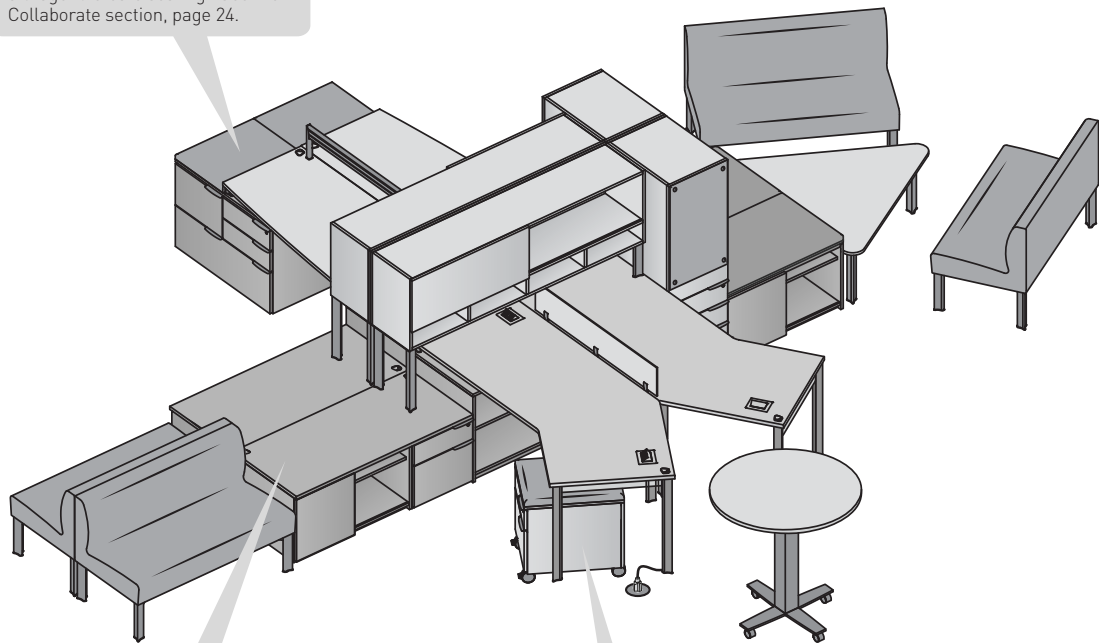

TIP! Modular tops must be ordered separately for bench height units. Storage units can be mounted under a common top to create a custom look.

TIP! Add additional storage and seating with a cushion top mobile pedestal from the Collaborate section, see page 24.

TIP! If an electrical worksurface was selected, be sure to complete the electrical options shown in the Electrical section, see page 26.

www.swish.jsifurniture.com

Call 800 457 4511 to discuss your project with a JSI Swish expert!

executive height units (26" h without spacer and worksurface)

For a floating top, choose the executive height units and have your worksurface just inches away from your undersurface storage. Use corner units to create the look of a full pedestal from the approach side.

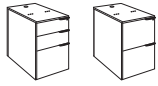

b/b/f & f/f pedestals
 36" d x 18" w
 30" d x 18" w
 24" d x 18" w
 18" d x 18" w



b/b lateral file pedestal
 24" d x 36" w
 24" d x 30" w
 18" d x 36" w
 18" d x 30" w



lateral file pedestal
 30" d x 36" w*
 24" d x 36" w*
 24" d x 30" w*
 18" d x 36" w*
 18" d x 30" w*

*Can also be ordered as an extended unit for mid-mount applications to allow part of the unit to be outside of the worksurface.



multi-file pedestal
 30" d x 36" w
 24" d x 36" w
 18" d x 36" w

Can also be ordered as an extended unit for mid-mount applications to allow part of the unit to be outside of the worksurface.



sliding door pedestal
 24" d x 36" w*
 24" d x 30" w
 18" d x 36" w*
 18" d x 30" w*

*Can also be ordered as an extended unit for mid-mount applications to allow part of the unit to be outside of the worksurface.

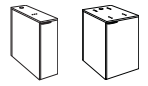

hinged door pedestal
 30" d x 9" w
 24" d x 36" w
 24" d x 30" w
 24" d x 18" w
 24" d x 9" w
 18" d x 36" w
 18" d x 30" w
 18" d x 18" w
 18" d x 9" w

Includes an adjustable shelf.

36" w and 30" w have two doors, 18" w and 9" w have one door.

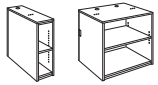

open storage/shelf pedestals
 30" d x 9" w
 24" d x 36" w
 24" d x 30" w
 24" d x 18" w
 24" d x 9" w
 18" d x 36" w
 18" d x 30" w
 18" d x 18" w
 18" d x 9" w

Includes an adjustable shelf.
 36" w, 30" w and 18" w have a shelf, 9" w does not.



connection pedestal
 24" d x 36" w
 24" d x 30" w
 24" d x 24" w
 24" d x 18" w
 18" d x 36" w
 18" d x 30" w
 18" d x 24" w
 18" d x 18" w

Use this pedestal when linking electrified pedestals in a run. Side access pass through grommets allow cords to route through the unit.

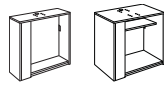

open storage/shelf corner
 36" d x 24" w
 36" d x 18" w
 36" d x 9" w
 30" d x 24" w
 30" d x 18" w
 30" d x 9" w
 24" d x 24" w
 24" d x 18" w
 24" d x 9" w

18" d x 24" w
 18" d x 18" w
 18" d x 9" w

18" w has a shelf, 9" w does not.



hinged door corner
 30" d x 24" w
 30" d x 18" w
 30" d x 9" w
 24" d x 24" w
 24" d x 18" w
 24" d x 9" w
 18" d x 24" w
 18" d x 18" w
 18" d x 9" w



kneespace corner
 36" d x 24" w
 36" d x 18" w
 30" d x 24" w
 30" d x 18" w
 24" d x 24" w
 24" d x 18" w
 18" d x 24" w
 18" d x 18" w

Use this with bridges or returns to eliminate knee-knocking.

bench height units (19 1/4" h without modular top)

Bench height storage units achieve the layered look by allowing perching areas and multiple low storage configurations. Bench height storage units must have a top specified separately. To create a custom look, put multiple units under one common top.

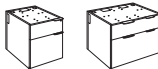

b/f pedestal
 24" d x 36" w
 24" d x 30" w
 24" d x 24" w
 24" d x 18" w
 18" d x 36" w
 18" d x 30" w
 18" d x 24" w
 18" d x 18" w

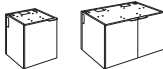

hinged door pedestal
 24" d x 36" w
 24" d x 30" w
 24" d x 24" w
 24" d x 18" w
 18" d x 36" w
 18" d x 30" w
 18" d x 24" w
 18" d x 18" w

36" w, 30" w and 24" w have two doors, 18" w has one door.



sliding door pedestal
 24" d x 36" w
 24" d x 30" w
 18" d x 36" w
 18" d x 30" w



open shelf pedestal
 24" d x 36" w
 24" d x 30" w
 24" d x 24" w
 24" d x 18" w
 18" d x 36" w
 18" d x 30" w
 18" d x 24" w
 18" d x 18" w

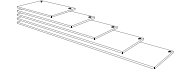

modular tops
 24" d x 108" w 18" d x 108" w
 24" d x 102" w 18" d x 102" w
 24" d x 96" w 18" d x 96" w
 24" d x 90" w 18" d x 90" w
 24" d x 84" w 18" d x 84" w
 24" d x 78" w 18" d x 78" w
 24" d x 72" w 18" d x 72" w
 24" d x 66" w 18" d x 66" w
 24" d x 60" w 18" d x 60" w
 24" d x 54" w 18" d x 54" w
 24" d x 48" w 18" d x 48" w
 24" d x 42" w 18" d x 42" w
 24" d x 36" w 18" d x 36" w
 24" d x 30" w 18" d x 30" w
 24" d x 24" w 18" d x 24" w
 24" d x 18" w 18" d x 18" w

Tops are standard with grommets on the left and right sides that align with the grommets in the unit below.

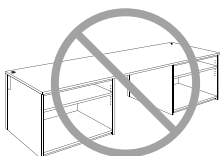

TIP! Tops are not designed to span two bench height storage units with an unsupported area.

step
2

Specifying Swish Step Two (continued)

undersurface storage & supports

Select your worksurface support...

- 2-E Determine how many points of support are needed.
- 2-F Choose type of undersurface support.

➤ Undersurface supports are made of anodized aluminum and feature a removable cover to hide cords.

Determine the support needed.

Now you will need to support your worksurface to the height of storage you selected or run a full leg to the floor. Each worksurface shape has requirements for support.



rectangle
Support required...
L R



fin
Support required...
L R

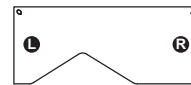

nook
Support required...
L R

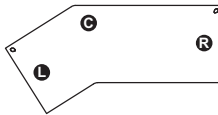

boomerang
Support required...
L C R

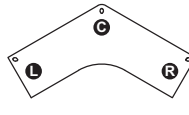

120°
Support required...
L C R

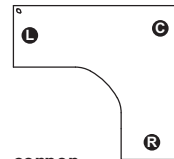

corner
Support required...
L C R

TIP! Center support must be a single leg to the floor.

TIP! Center support options include a single leg to the floor, single leg to bench height or single spacer to executive height.

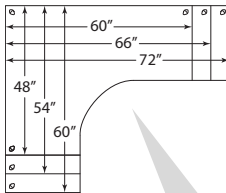

TIP! 72" side must use a 9", 18" or 30" pedestal, legs to the floor, or bracket to tall storage.

66" and 60" side must use a 9" or 18" pedestal, legs to the floor, or bracket to tall storage.

54" side must use a 9" pedestal, legs to the floor, or bracket to tall storage.

48" side must use legs to the floor.

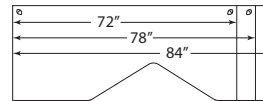

TIP! 84" tops must use an 18" or 9" pedestal or legs to the floor on the 18" w side.

78" tops must use a 9" pedestal or legs to the floor on the 12" w side.

72" tops must use legs to the floor on the 6" w side.

www.swish.jsifurniture.com

Call 800 457 4511 to discuss your project with a JSI Swish expert!

Worksurface support choices.

spacer to executive height

Use this spacer-support to connect worksurfaces to executive height storage units.

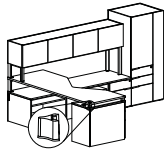

leg to bench height

Use this support to connect worksurfaces to low bench height storage units.

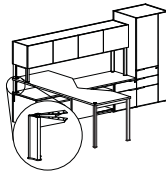

leg to floor

Use this full leg to support a work surface that sits directly on the floor.

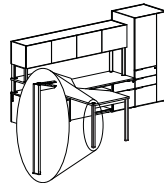

bracket to tall storage

Use this bracket to attach a work surface to a tall storage unit. Includes one SSK-TOPSPACER1 for use with plenum.

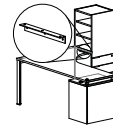

Worksurfaces include: wire management channel, stress bar, plenum for approach side and end, and plenum retainers.

Worksurfaces that are 84" w must use at least one 18" w pedestal for support.

Worksurfaces that are 90" w must use two 18" w pedestals OR one 18" w and one 9" w pedestal for support.

Worksurfaces that are 96" w must use two 18" w pedestals for support.

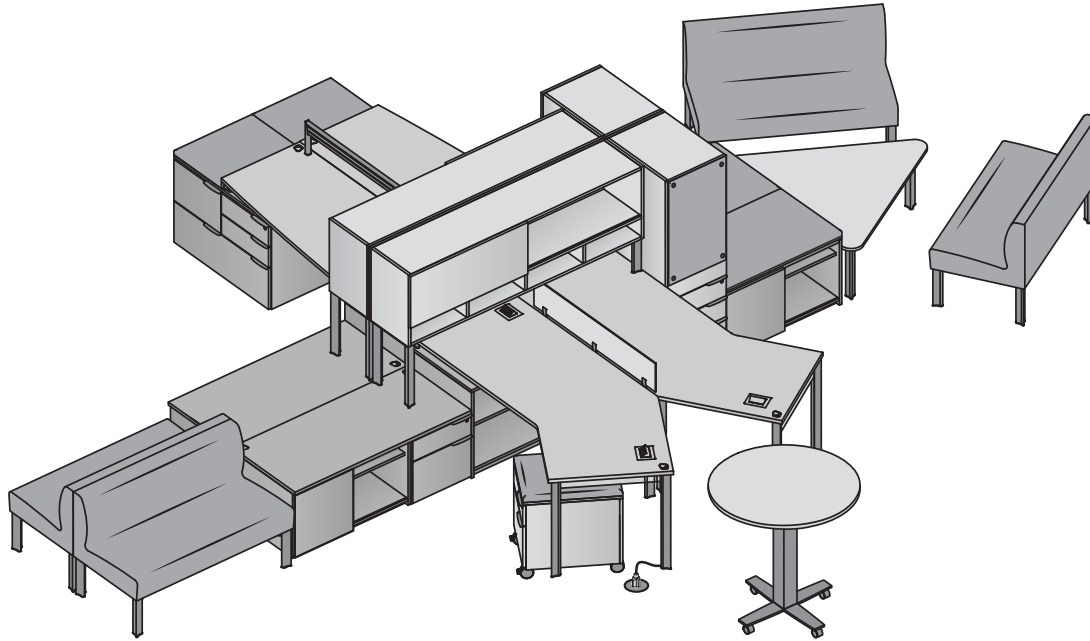

worksurface supports

Supports are used to connect the worksurface with various pedestals, storage units or to run to the floor.



spacer to executive height
2 1/4" h



leg to bench height
9 1/2" h



leg to floor
29 1/2" h



bracket to tall storage
18" w, 24" w, 30" w, 36" w

step

3

Specifying Swish Step Three

tall storage

Select tall storage components to add storage and privacy...

- 3-A Choose a style.
- 3-B Determine depth.
- 3-C Determine width and height.
- 3-D Specify a laminate.

- When attaching a worksurface to a tall storage unit, make sure that the bracket to tall storage support option was specified in Step 2.

Select tall storage.

Tall storage units can stand alone or be mounted to a worksurface and used for support.

TIP! Tall storage units and bench height storage units have side access grommets to allow cords to pass through entire unit.

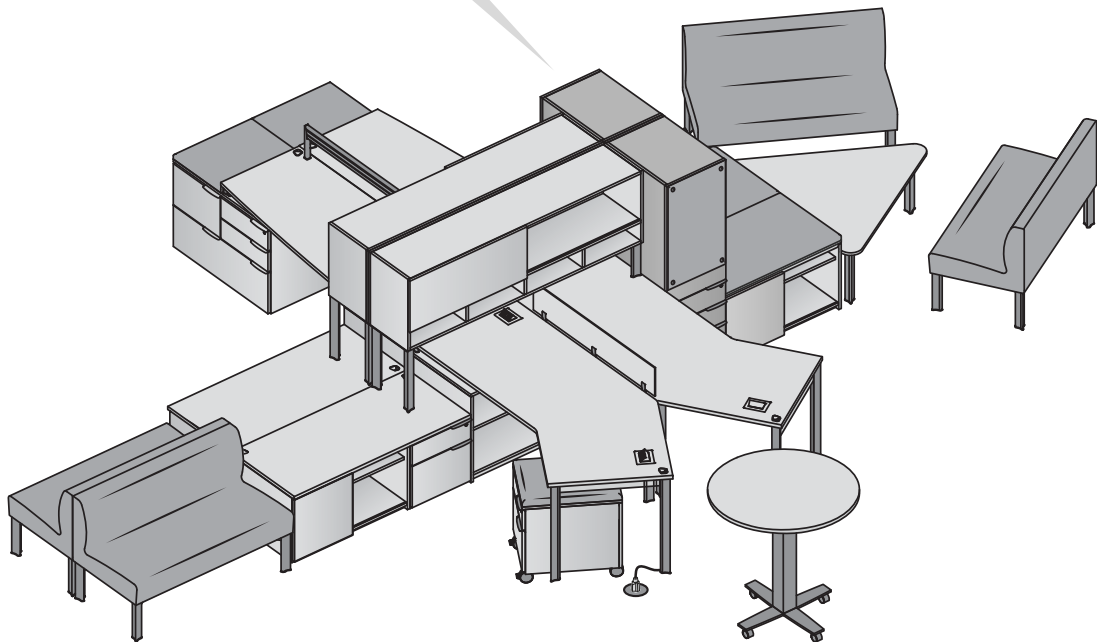

www.swish.jsifurniture.com

Call 800 457 4511 to discuss your project with a JSI Swish expert!

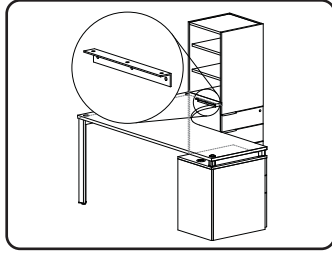

the "L" connection

Specify an L-bracket to connect a tall storage unit to a work surface.

tall storage units

Attach the work surface directly to a tall storage unit to create space dividers or varied height storage.

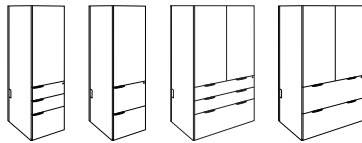

b/b/f & f/f storage cabinets

- 24" d x 36" w x 60" h
- 24" d x 30" w x 60" h
- 24" d x 18" w x 60" h
- 18" d x 36" w x 60" h
- 18" d x 30" w x 60" h
- 18" d x 18" w x 60" h
- 24" d x 36" w x 54" h
- 24" d x 30" w x 54" h
- 24" d x 18" w x 54" h
- 18" d x 36" w x 54" h
- 18" d x 30" w x 54" h
- 18" d x 18" w x 54" h

60" h units have two adjustable shelves, 54" h and 45" h have one shelf.
30" w and 36" w units have two doors, 18" w has one door.



b/b/f side access storage cabinet

- 24" d x 18" w x 60" h
- 18" d x 18" w x 60" h
- 24" d x 18" w x 54" h
- 18" d x 18" w x 54" h
- 24" d x 18" w x 45" h
- 18" d x 18" w x 45" h

60" h units have two adjustable shelves, 54" h and 45" h have one shelf.

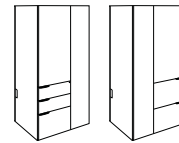

b/b/f & f/f storage wardrobes

- 24" d x 30" w x 60" h
- 18" d x 30" w x 60" h
- 24" d x 30" w x 54" h
- 18" d x 30" w x 54" h
- 24" d x 30" w x 45" h
- 18" d x 30" w x 45" h

60" h units have two adjustable shelves, 54" h and 45" h have one shelf.
24" wardrobe units include a chrome hanging bar.

18" wardrobe units include a coat hook.



single door storage cabinet

- 24" d x 18" w x 60" h
- 18" d x 18" w x 60" h
- 24" d x 18" w x 54" h
- 18" d x 18" w x 54" h
- 24" d x 18" w x 45" h
- 18" d x 18" w x 45" h

60" h and 54" h units have three adjustable shelves, 45" h has two shelves.



double door storage cabinet

- 24" d x 36" w x 60" h
- 24" d x 30" w x 60" h
- 18" d x 36" w x 60" h
- 18" d x 30" w x 60" h
- 24" d x 36" w x 54" h
- 24" d x 30" w x 54" h
- 18" d x 36" w x 54" h
- 18" d x 30" w x 54" h
- 24" d x 36" w x 45" h
- 24" d x 30" w x 45" h
- 18" d x 36" w x 45" h
- 18" d x 30" w x 45" h

60" h and 54" h units have three adjustable shelves, 45" h has two shelves.

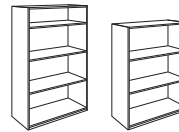

bookcases

- 15" d x 36" w x 60" h
- 15" d x 30" w x 60" h
- 15" d x 18" w x 60" h
- 15" d x 36" w x 54" h
- 15" d x 30" w x 54" h
- 15" d x 18" w x 54" h
- 15" d x 36" w x 45" h
- 15" d x 30" w x 45" h
- 15" d x 18" w x 45" h

60" h and 54" h units have three adjustable shelves, 45" h has two shelves.

step

4

Specifying Swish Step Four

above surface storage & supports

Add overhead storage units and cubbies to expand your workspace...

4-A Choose type of above surface storage.

4-B Choose style.

4-C Determine width.

➤ Storage can be specified in 7 solid laminates and 11 woodgrain laminates. For additional surface materials information, see page 38.

➤ Wall mount units available for 15" overheads and 21" overheads with cubby below.

Select above surface storage.

Use above surface units for additional storage and as a space divider.

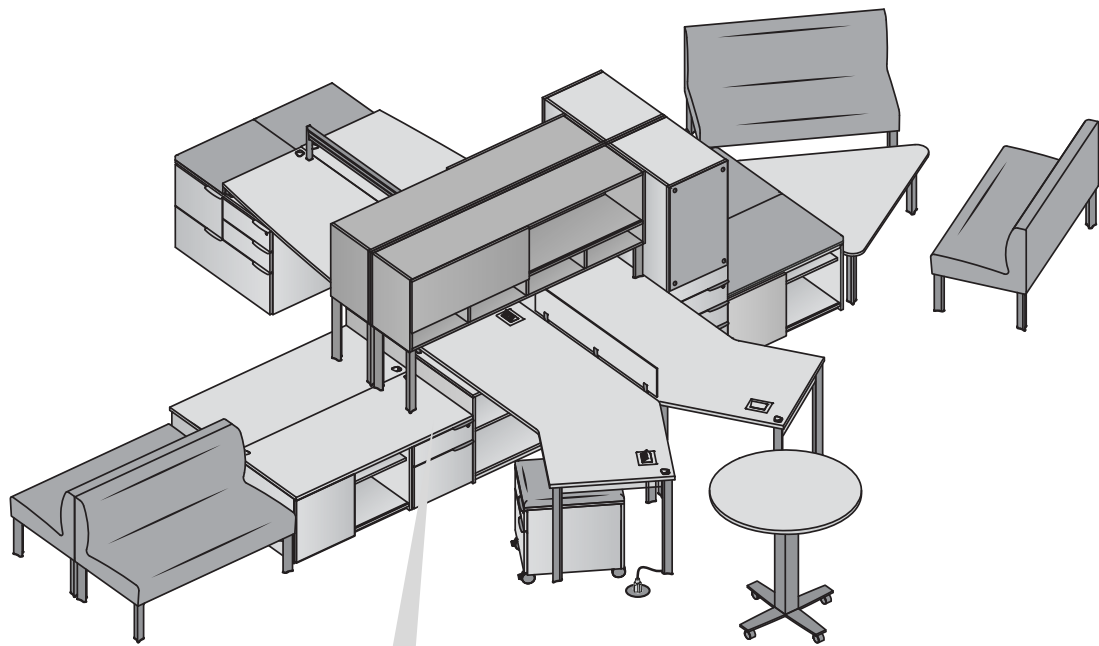

TIP! Above surface storage units can sit on varied height worksurfaces. One end can sit on executive height, while the other is on bench height.

www.swish.jsifurniture.com

Call 800 457 4511 to discuss your project with a JSI Swish expert!

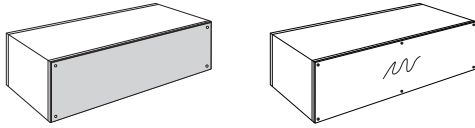

dual purpose

Tackboards and markerboards can be added to the backside of an overhead to increase productivity when sharing spaces. Review the Accessories section, see page 22.

overheads

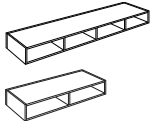

6" horizontal cubby organizer

- 15"d x 84"w x 6"h
- 15"d x 78"w x 6"h
- 15"d x 72"w x 6"h
- 15"d x 66"w x 6"h
- 15"d x 60"w x 6"h
- 15"d x 54"w x 6"h
- 15"d x 48"w x 6"h
- 15"d x 42"w x 6"h
- 15"d x 36"w x 6"h
- 15"d x 30"w x 6"h

Using storage supports, total height can be either 45" or 54" from the floor.

Cubbies 54"w and larger have four cubby openings, and units 48"w and smaller have two cubby openings.

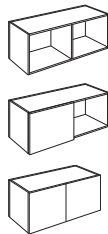

15" overhead

- 15"d x 84"w x 15"h
- 15"d x 78"w x 15"h
- 15"d x 72"w x 15"h
- 15"d x 66"w x 15"h
- 15"d x 60"w x 15"h
- 15"d x 54"w x 15"h
- 15"d x 48"w x 15"h
- 15"d x 42"w x 15"h
- 15"d x 36"w x 15"h
- 15"d x 30"w x 15"h

Using storage supports, total height can be either 54" or 60" from the floor.

15"h overheads are also available as wall mount.

Units 54"w and larger have four doors, 48"w and 42"w units have three doors, and 36"w and 30"w units have two doors.

Three door units can have one door hinge right and two left, or two hinge right and one left.

Hinge door units are also available with glass doors, and sliding door units are also available with markerboards.

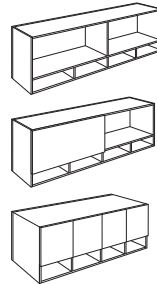

21" overhead with cubby below

- 15"d x 84"w x 21"h
- 15"d x 78"w x 21"h
- 15"d x 72"w x 21"h
- 15"d x 66"w x 21"h
- 15"d x 60"w x 21"h
- 15"d x 54"w x 21"h
- 15"d x 48"w x 21"h
- 15"d x 42"w x 21"h
- 15"d x 36"w x 21"h
- 15"d x 30"w x 21"h

Using storage supports, total height will be 60" from the floor.

21"h overhead/cubby combinations are also available as wall mount.

Open storage units 54"w and larger have two overhead openings and four cubbies, units 48"w and smaller have two overhead openings and two cubbies.

Hinge door units are also available with glass doors, and sliding door units are also available with markerboards.

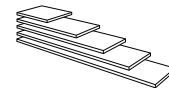

transaction top

- 15"d x 84"w x 1 3/16"h
- 15"d x 78"w x 1 3/16"h
- 15"d x 72"w x 1 3/16"h
- 15"d x 66"w x 1 3/16"h
- 15"d x 60"w x 1 3/16"h
- 15"d x 54"w x 1 3/16"h
- 15"d x 48"w x 1 3/16"h
- 15"d x 42"w x 1 3/16"h
- 15"d x 36"w x 1 3/16"h
- 15"d x 30"w x 1 3/16"h

Using storage supports, total height can be either 40" or 46" from the floor.

NOTE! Support legs must be specified to support overhead and cubby units that are not wall mounted, see page 20.

step

4

Specifying Swish Step Four (continued)

above surface storage & supports

Add overhead storage units and cubbies to expand your workspace...

- 4-D** Determine the height desired for the overhead unit, from the floor.
 - 4-E** Identify if the above surface storage unit will sit on an executive height unit or a bench height unit.
 - 4-F** Select the appropriate storage support to achieve the overall height.
- 6" cubby units can be either 45" or 54" from the floor.
 - 15" overhead units can be either 54" or 60" from the floor, or wall mounted.
 - 21" overhead units with cubbies below will be 60" from the floor, or can be wall mounted.
 - Transaction tops can be either 40" or 46" from the floor.

Select above surface storage supports.

Overhead storage units and cubbies can be added at various heights to accommodate your work style and storage needs. Wall mount overhead units do not require storage supports.

TIP! The backsides of above surface storage units are always finished, so they make great space dividers.

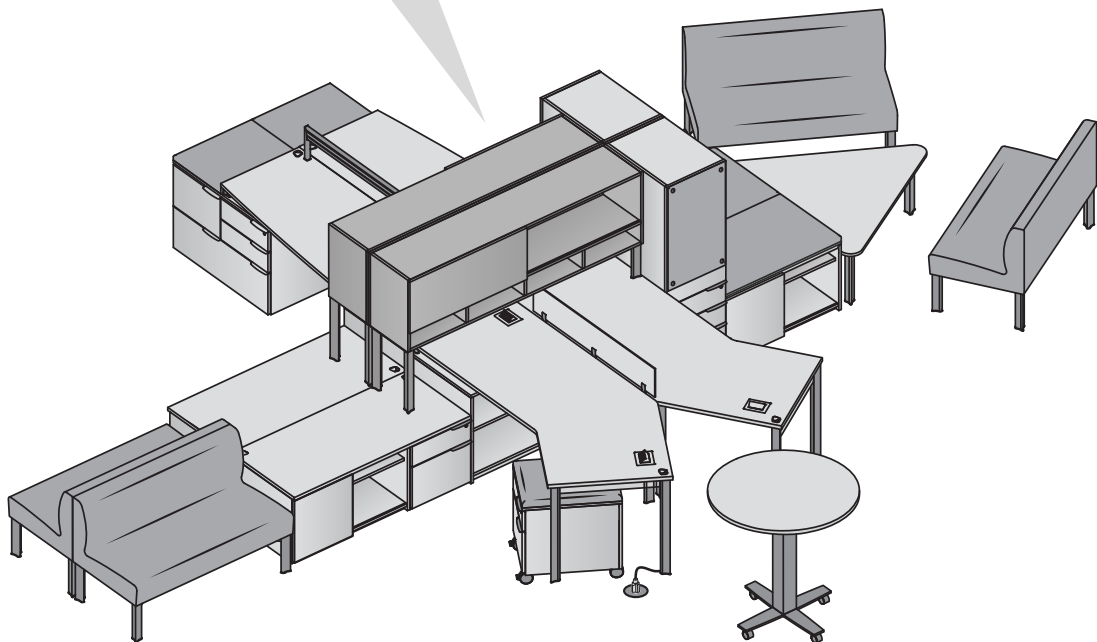

Above executive height storage supports...

Use this matrix to choose the correct support for above surface storage when placing over executive height surfaces.



executive height to above surface storage		to achieve an overall height of...	40"	45"	46"	54"	60"
6" cubby		-	SSK-OHS-A	-	SSK-OHS-C	-	
15" overhead		-	-	-	-	SSK-OHS-A	SSK-OHS-B
21" overhead with cubby		-	-	-	-	-	SSK-OHS-A
transaction top		SSK-OHS-A	-	SSK-OHS-B	-	-	

Above bench height storage supports...

Use this matrix to choose the correct support for above surface storage when placing over bench height surfaces.

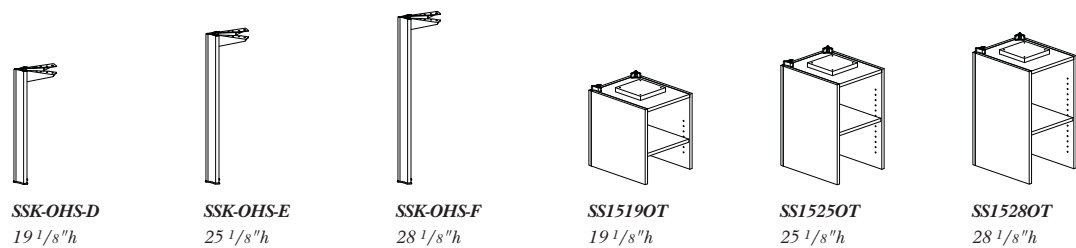

bench height to above surface storage		to achieve an overall height of...	40"	45"	46"	54"	60"
6" cubby		-	SSK-OHS-D or SS15190T	-	SSK-OHS-F or SS15280T	-	
15" overhead		-	-	-	-	SSK-OHS-D or SS15190T	SSK-OHS-E or SS15250T
21" overhead with cubby		-	-	-	-	-	SSK-OHS-D or SS15190T
transaction top		SSK-OHS-D or SS15190T	-	SSK-OHS-E or SS15250T	-	-	

step
5

Specifying Swish Step Five

accessories

Divide space for more privacy, add modesty panels or create tackable surfaces for increased functionality...

- 5-A Determine your accessory needs.
- 5-B Choose your upholstery and/or acrylic.

➤ Modesty panels and privacy screens can be specified in 6 acrylic designs. For available standard and premium acrylics, see page 39. Privacy screens with tackboards are only available with the standard frosted acrylic.

Select accessories.

Select accessories to maximize efficiency and make your space work for you.

Accessory rail tools...



pencil holder/organizer



organizer tray



letter tray



shelf

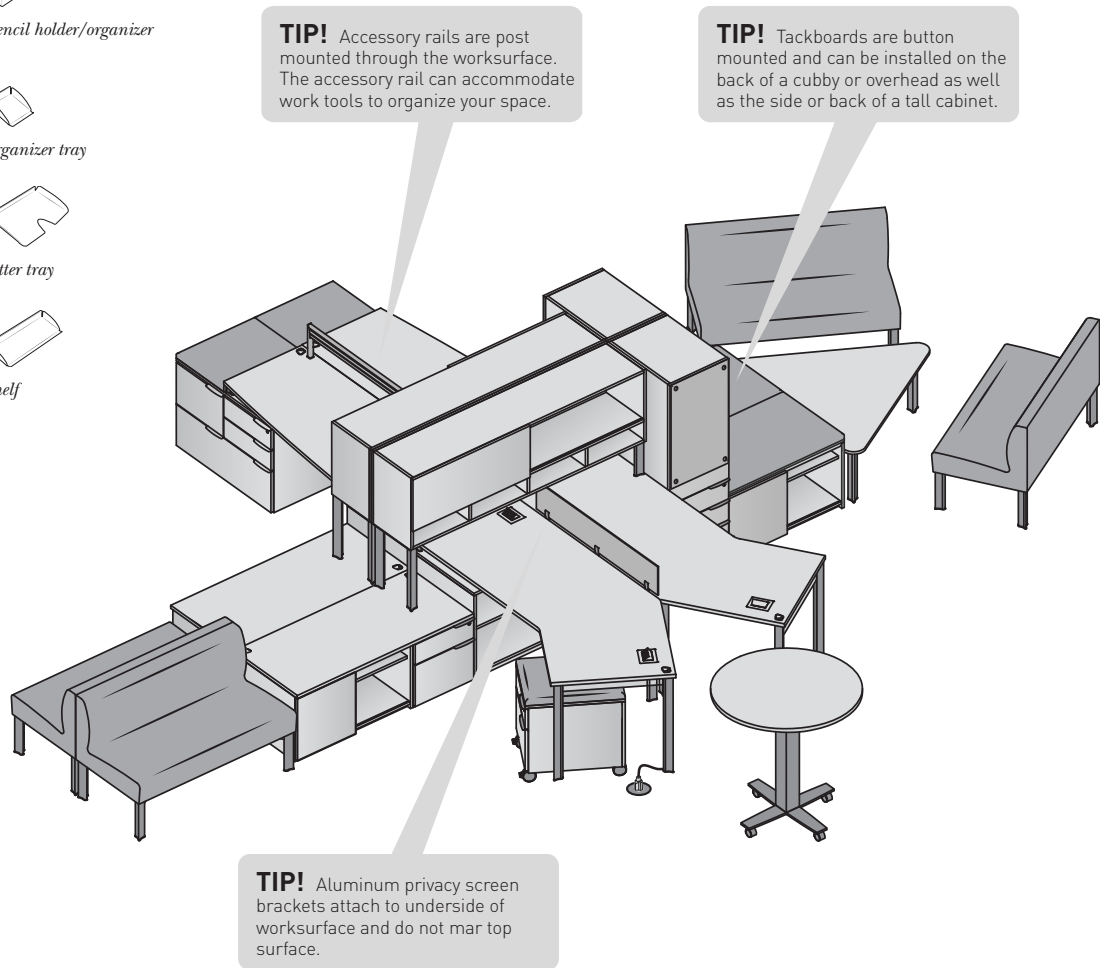

www.swish.jsifurniture.com

Call 800 457 4511 to discuss your project with a JSI Swish expert!

markerboards

For the backs of overheads, overhead and cubby combinations, as well as the backs and sides of tall storage units.



- 15" overhead**
 15" h x 84" w
 15" h x 78" w
 15" h x 72" w
 15" h x 66" w
 15" h x 60" w
 15" h x 54" w
 15" h x 48" w
 15" h x 42" w
 15" h x 36" w
 15" h x 30" w



- 21" overhead/cubby**
 21" h x 84" w
 21" h x 78" w
 21" h x 72" w
 21" h x 66" w
 21" h x 60" w
 21" h x 54" w
 21" h x 48" w
 21" h x 42" w
 21" h x 36" w
 21" h x 30" w



- back of tall storage**
 27" h x 36" w
 27" h x 30" w
 27" h x 18" w

 21" h x 36" w
 21" h x 30" w
 21" h x 18" w

 12" h x 36" w
 12" h x 30" w
 12" h x 18" w



- side of tall storage**
 27" h x 23" w
 27" h x 17" w

 21" h x 23" w
 21" h x 17" w

 12" h x 23" w
 12" h x 17" w



- side of side access**
 21" h x 18" w
 18" h x 18" w
 12" h x 18" w

tackboards

For the backs of cubbies, overheads, overhead and cubby combinations, as well as the backs and sides of tall storage units.

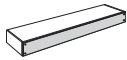

- 6" cubby**
 6" h x 84" w
 6" h x 78" w
 6" h x 72" w
 6" h x 66" w
 6" h x 60" w
 6" h x 54" w
 6" h x 48" w
 6" h x 42" w
 6" h x 36" w
 6" h x 30" w

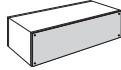

- 15" overhead**
 15" h x 84" w
 15" h x 78" w
 15" h x 72" w
 15" h x 66" w
 15" h x 60" w
 15" h x 54" w
 15" h x 48" w
 15" h x 42" w
 15" h x 36" w
 15" h x 30" w

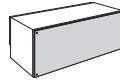

- 21" overhead/cubby**
 21" h x 84" w
 21" h x 78" w
 21" h x 72" w
 21" h x 66" w
 21" h x 60" w
 21" h x 54" w
 21" h x 48" w
 21" h x 42" w
 21" h x 36" w
 21" h x 30" w



- back of tall storage**
 27" h x 36" w
 27" h x 30" w
 27" h x 18" w

 21" h x 36" w
 21" h x 30" w
 21" h x 18" w

 12" h x 36" w
 12" h x 30" w
 12" h x 18" w



- side of tall storage**
 27" h x 23" w
 27" h x 17" w

 21" h x 23" w
 21" h x 17" w

 12" h x 23" w
 12" h x 17" w



- side of side access**
 21" h x 18" w
 18" h x 18" w
 12" h x 18" w

privacy screens

Privacy screens provide reduced noise transfer from one station to another. Privacy screens are available with tackboards attached to them. They must be ordered with the tackboard factory installed. Tackboards cannot be added to privacy screens in the field.



rectangle

- 9" h x 83 3/4" w
 9" h x 77 3/4" w
 9" h x 71 3/4" w
 9" h x 65 3/4" w
 9" h x 59 3/4" w
 9" h x 53 3/4" w

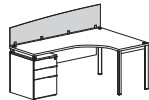

rectangle & fin

- 12" h x 83 3/4" w
 12" h x 77 3/4" w
 12" h x 71 3/4" w
 12" h x 65 3/4" w
 12" h x 59 3/4" w
 12" h x 53 3/4" w

rectangle & fin

- 15" h x 83 3/4" w
 15" h x 77 3/4" w
 15" h x 71 3/4" w
 15" h x 65 3/4" w
 15" h x 59 3/4" w
 15" h x 53 3/4" w

Fin Privacy Screens - The arc on the 12" h models is from 9" to 12" and the arc on the 15" models is from 12" to 15".

NOTE! 9" rectangle and 12" fin are not available with a tackboard.

modesty panels

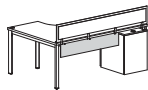

rectangle

- 9" h x 67" w
 9" h x 64" w
 9" h x 61" w
 9" h x 58" w
 9" h x 55" w
 9" h x 52" w
 9" h x 49" w
 9" h x 46" w
 9" h x 43" w

rectangle

- 15" h x 67" w
 15" h x 64" w
 15" h x 61" w
 15" h x 58" w
 15" h x 55" w
 15" h x 52" w
 15" h x 49" w
 15" h x 46" w
 15" h x 43" w

accessory rails

Accessory rails must be installed at least 4" inset from the left and right sides of the surface.



rail

- 9 1/4" h x 65" w
 9 1/4" h x 59" w
 9 1/4" h x 47" w
 9 1/4" h x 41" w
 9 1/4" h x 35" w
 9 1/4" h x 29" w
 9 1/4" h x 23" w
 9 1/4" h x 17" w

step
6

Specifying Swish Step Six

collaborate

Add integrated collaboration elements to invite impromptu meetings and gain efficiency...

6-A Determine your collaborative needs.

6-B Choose your laminate and/or upholstery.

- Create lounge spaces with integrated benches and tables.
- Add cushion tops to bench height storage for additional seating spaces or add a conference table for larger meetings.

Collaborate.

Swish was designed for people who work with people. Gather around a workstation, add collaborative spaces to a private office or create a meeting room with Swish's collaborate components.

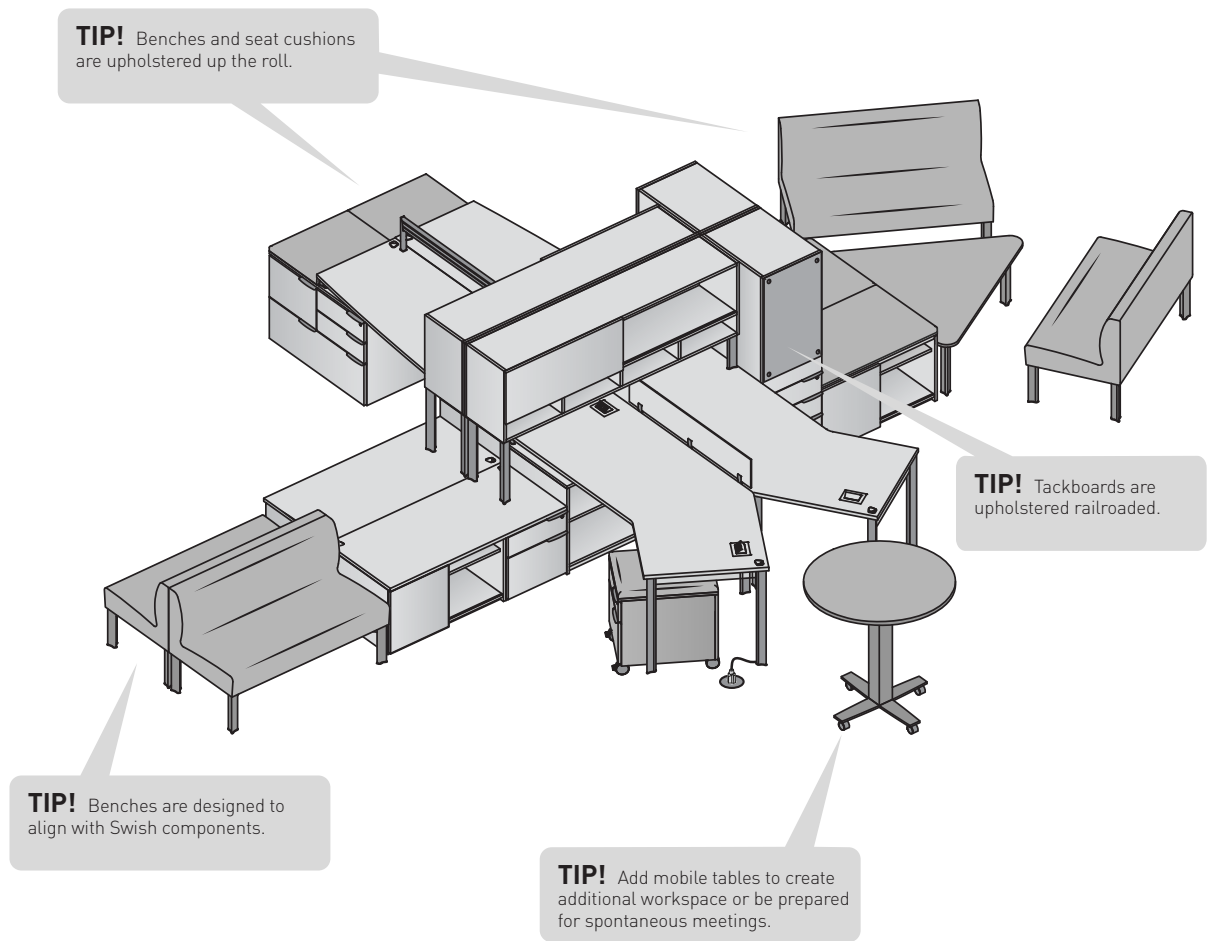

www.swish.jsifurniture.com

Call 800 457 4511 to discuss your project with a JSI Swish expert!

collaboration conference tables

Collaboration conference table tops must have two base units specified for support. Collaboration conference table tops do not have grommets. Grommet cutouts to accommodate an EC13 unit can be specified for the center of the table.



collaboration conference table tops

- 42"d x 84"w
- 42"d x 78"w
- 42"d x 72"w
- 42"d x 66"w
- 42"d x 60"w

Table tops include plenum, spacers and panel stretchers to conceal technology cords.

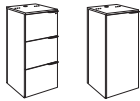

stand up height bases

18"d x 18"w x 37 13/16"h

Use these bases when creating a standing height work table or to use with stools for seating.

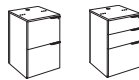

executive height bases

18"d x 18"w x 26"h

Use these bases when creating a standard height work table.

integrated collaboration conference tables



integrated collaboration table tops using L-bracket support and pedestal base supports

- | | | |
|-------------|-------------|-------------|
| 30"d x 72"w | 36"d x 72"w | 48"d x 72"w |
| 30"d x 66"w | 36"d x 66"w | 48"d x 66"w |
| 30"d x 60"w | 36"d x 60"w | 48"d x 60"w |
| 30"d x 54"w | 36"d x 54"w | 48"d x 54"w |

Tops include plenum, spacers and panel stretchers to conceal technology cords. Tops include one L-bracket to attach to a tall storage unit or wall mounted. Support for the other end must be ordered separately. Grommet cutouts to accommodate an EC13 unit can be specified for the center of the table.



stand up height bases

18"d x 18"w x 37 13/16"h

Use these bases when creating a standing height work table or to use with stools for seating.

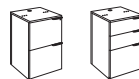

executive height bases

18"d x 18"w x 26"h

Use these bases when creating a standard height work table.

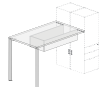

integrated collaboration table tops using L-bracket support and leg supports

- | | | |
|-------------|-------------|-------------|
| 30"d x 60"w | 36"d x 60"w | 48"d x 60"w |
| 30"d x 54"w | 36"d x 54"w | 48"d x 54"w |
| 30"d x 48"w | 36"d x 48"w | 48"d x 48"w |
| 30"d x 42"w | 36"d x 42"w | 48"d x 42"w |

Tops include panel stretchers to conceal technology cords. Tops include one L-bracket to attach to a tall storage unit or wall mounted, and includes one set of legs. Leg supports available in stand up height and executive height. Grommet cutouts to accommodate an EC13 unit can be specified for the center of the table.

height adjustable tables

Available with pneumatic or ratchet style height adjustability.

Available with locking casters or as a stationary table.

Pneumatic tables with casters adjust from 30 1/2"- 47 1/2" and stationary tables adjust from 27 1/2"- 44 1/2". Ratchet tables adjust from 27 3/8"- 36 3/4".



squircle

- 36"d x 36"w
- 30"d x 30"w



round

- 36"d x 36"w
- 30"d x 30"w

executive height work tables



rectangle

- 24"d x 78"w
- 24"d x 72"w
- 24"d x 66"w
- 24"d x 60"w



square

- 36"d x 78"w
- 36"d x 72"w
- 36"d x 66"w
- 36"d x 60"w

- 30"d x 78"w
- 30"d x 72"w
- 30"d x 66"w
- 30"d x 60"w

- 42"d x 78"w
- 42"d x 72"w
- 42"d x 66"w
- 42"d x 60"w

loungue tables



triangle

- 48"d x 48"w x 23"h
- 36"d x 36"w x 23"h



rectangle

- 24"d x 48"w x 23"h

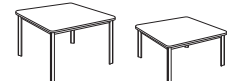

square

- 42"d x 42"w x 23"h
- 36"d x 36"w x 17"h
- 30"d x 30"w x 17"h
- 24"d x 24"w x 17"h

upholstered benches

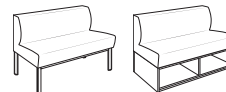

4 legs or open shelf

- 24"d x 48"w x 29"h
- 24"d x 36"w x 29"h
- 24"d x 30"w x 29"h
- 24"d x 24"w x 29"h

mobile pedestal



mobile pedestal

- 20"d x 18"w x 24 1/2"h

Features locking casters and upholstered cushion top.

seat cushions



- | | |
|-----------------------|-----------------------|
| 18"d x 36"w x 1 1/2"h | 24"d x 36"w x 1 1/2"h |
| 18"d x 30"w x 1 1/2"h | 24"d x 30"w x 1 1/2"h |
| 18"d x 24"w x 1 1/2"h | 24"d x 24"w x 1 1/2"h |
| 18"d x 18"w x 1 1/2"h | 24"d x 18"w x 1 1/2"h |

step
7

Specifying Swish Step Seven

electrical

Continue specifying your power options to complete your workstation...

- 7-A Determine power infeed length.**
 - 7-B Connect power infeed to worksurface.**
 - 7-C Connect executive height worksurfaces to each other.**
 - 7-D Continue power through storage units to another station.**
- This panel-less 4 wire, 2 circuit system easily runs throughout an entire workstation.
 - Swish was designed with integrated wire management to create omni-directional movement.
 - Each circuit can have up to 13 duplexes, which is 26 plug-ins.

Undersurface electrical.

Complete your workstation's electrical options by specifying the power infeed and jumpers. These components allow the power to travel from the worksurface through the undersurface units or travel from worksurface to worksurface to power multiple stations.

power entry infeed

7-A1 Measure distance between power source and location that power will enter the Swish station.

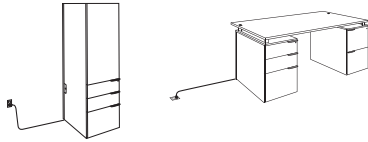

7-A2 Select location of power entry from the floor, and add length.

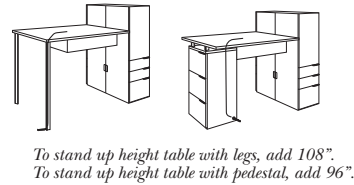
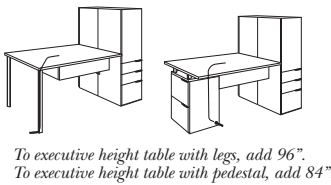
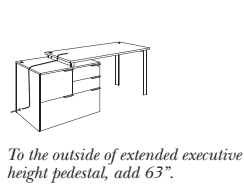
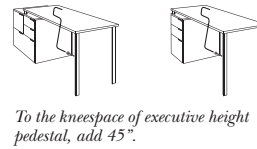
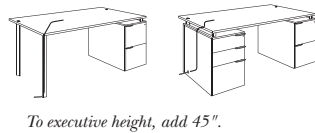
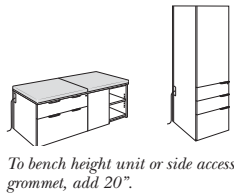

7-A3 If applicable, add the width of any additional units leading to the powered worksurface.

7-A1 + **7-A2** + **7-A3** = length of power infeed

connect power infeed to worksurface

7-B If a vertical height change is needed to reach the worksurface, specify the 24" vertical jumper.

connect executive height worksurfaces

7-C1 Connect executive height worksurfaces to each other with a simple jumper.

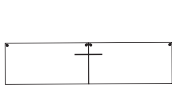

End to end, use 24" jumper.



Back to back, use 28" jumper.



End to end, opposite facing:
36"d & 30"d, use 28" jumper.
24"d & 18"d, use 24" jumper.

TIP! If worksurfaces have an overhang, add 6" for each worksurface.

7-C2 Connect executive height worksurfaces to bridges or returns with simple jumpers.

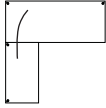

36"d worksurfaces, use 50" jumper.
30"d worksurfaces, use 45" jumper.
24"d worksurfaces, use 42" jumper.
18"d worksurfaces, use 31" jumper.

continue power to the next workstation, through storage units

7-D1 If a vertical height change is needed to reach the storage unit, specify the 24" vertical jumper.

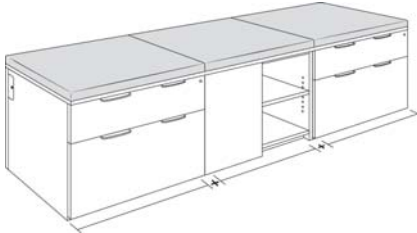

7-D2 Measure the widths of the units the jumper will travel through.

7-D3 If a vertical height change is needed to reach the worksurface, specify the 24" vertical jumper.

electrical

Electrical components to power your workstation.

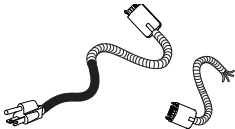

72" power infeed

Three prong available in 12" increments from 48" to 120".
Hardwire available in 12" increments from 72" to 300".

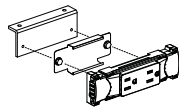

duplex receptacle kit

Includes mounting brackets.



receptacle to receptacle connector



H block connector kit

Includes mounting brackets.

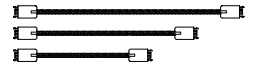

jumpers

Available in 6" increments from 18" to 300". Also available in 28", 31", 45", and 50" lengths.



conduit clamp



24" vertical jumper
(includes H block connector)



Quick disconnect



Field install grommet

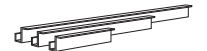

Wire management trough
Available in 12", 24", and 36" lengths.



Specifying Swish Pre-configured Models

pre-configured models

Use pre-configured models to create common workspaces, U-units and L-units...

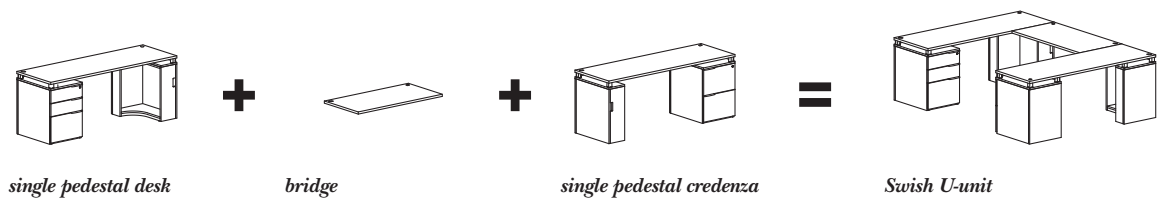
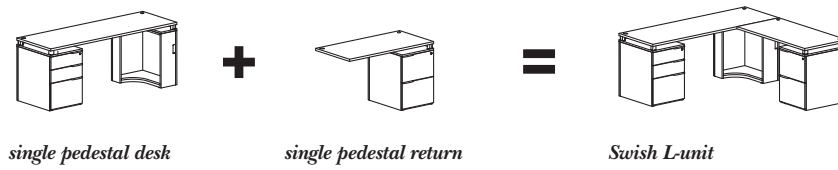
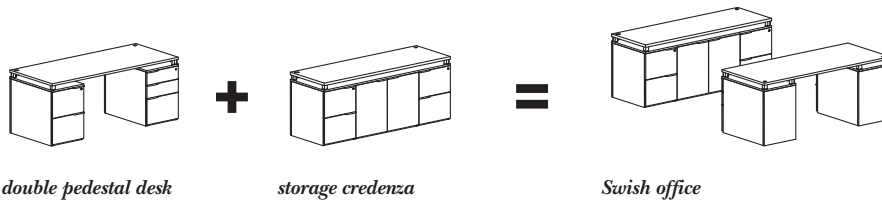

www.swish.jsifurniture.com

Call 800 457 4511 to discuss your project with a JSI Swish expert!

pre-configured models

Use these as they are or combine to create larger units. All pre-configured models are executive height, 29 3/8" h.

double pedestal desk

36" d x 72" w
36" d x 66" w

30" d x 72" w
30" d x 66" w

The 36" d units feature grommets that are inset 6" from the approach side to create an overhang.

single pedestal desk - rectangle & fin

36" d x 72" w*
36" d x 66" w*

30" d x 72" w*
30" d x 66" w*

30" d x 60" w (rectangle only)

Units with asterisk* are also available with grommets inset 6" to create an overhang on the approach side.

Single pedestal side is supported by b/b/f pedestal.

66" w and 72" w chassis have an 18" w corner wing for support and 60" w chassis have a 9" w corner wing.

**storage credenza
kneespace credenza**

24" d x 72" w
24" d x 66" w

18" d x 72" w
18" d x 66" w

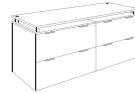
lateral file credenza

24" d x 72" w
24" d x 60" w

single pedestal credenza

24" d x 72" w
24" d x 66" w

18" d x 72" w
18" d x 66" w
18" d x 60" w

Available with standard f/f pedestal or lateral file pedestal on single pedestal side.

Available with 18" w corner wing support or 9" w wing support.

66" w and 72" w chassis have an 18" w corner wing for support and 60" w chassis have a 9" w corner wing.

**lateral file pedestal
hinged door pedestal**

24" d x 36" w
24" d x 30" w

18" d x 36" w*
18" d x 30" w*

Units with asterisk* are only available with hinged doors.

b/b/f pedestal

24" d x 36" w
24" d x 30" w

18" d x 36" w
18" d x 30" w

single pedestal return

24" d x 48" w
24" d x 42" w

18" d x 48" w
18" d x 42" w

Single pedestal side is supported by f/f pedestal.
Grain direction runs front to back on the worksurface.

bridge

24" d x 48" w
24" d x 42" w

18" d x 48" w
18" d x 42" w



Swish Idea Starters & Work Styles Typical Configurations

back to back

Connect individual stations with shared storage components and/or worksurfaces as a single unit.



Model numbers to create the above vignette...

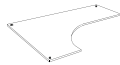

SST4872CRNRG-AB-R (qty 2)
corner workstation - right



SST4872CRNRG-BA-L (qty 2)
corner workstation - left



SS2418MFF (qty 4)
executive height
file/file pedestal



SSK-TOPSPACER2 (qty 4)
spacer to executive height



SSK-LEG1-29 (qty 4)
leg to floor



SSK-LBRKT-18 (qty 4)
bracket to tall storage



SS1818-54BBFSTL (qty 2)
tall storage cabinet
with side access - left



SS1818-54BBFSTR (qty 2)
tall storage cabinet
with side access - right

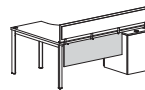

SS1546AMR (qty 4)
modesty panel

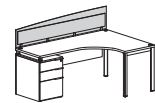

SS1548ASF-TK2 (qty 2)
fin privacy screen

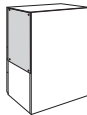

SS2117TK (qty 2)
tackboard for side
of tall storage

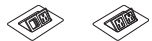

EC10 or EC11 (qty 4)
power or power/data unit

Additional idea starters for Back to Back applications...

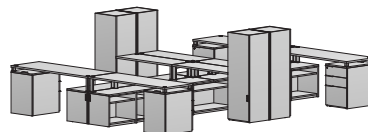
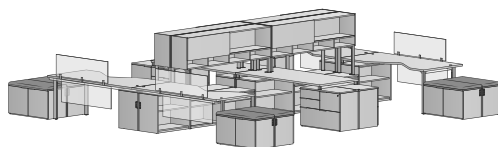

www.swish.jsifurniture.com

Call 800 457 4511 to discuss your project with a JSI Swish expert!



integrated collaboration

Turn spaces into multi-functional places by combining individual stations, meeting components, storage opportunities and seating options.



Model numbers to create the above vignette...



SST3084BMG-R (qty 2)
boomerang workspace - right



SST3084BMG-L (qty 2)
boomerang workspace - left



SS1830MRO (qty 4)
executive height
connection pedestal



SSB1818MBF (qty 4)
bench height
box/file storage



SSB1836MHD (qty 4)
bench height
hinged door storage



SSK-TOPSPACER2 (qty 4)
spacer to executive height



SSK-LEG2-29 (qty 4)
leg to floor



SS2142HDR (qty 2)
overhead cabinet
with cubby below - right



SS2142HDL (qty 2)
overhead cabinet
with cubby below - left



SSK-OHS-A (qty 4) and
SSK-OHS-D (qty 4)
leg to overhead



SS0940AR (qty 2)
accessory rail



SS36TRI-23 (qty 2)
triangle lounge table



SS3636SQCL (qty 1)
squircle adjustable height table



SS2448UBB (qty 1)
upholstered bench

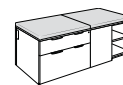

SSI836CUSH (qty 4)
seat cushion

Additional idea starters for Integrated Collaboration applications...

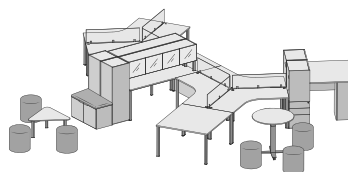
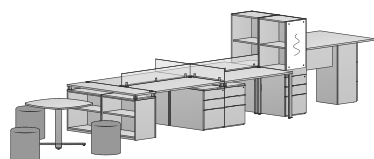



Swish Idea Starters & Work Styles Typical Configurations

forward-facing run

Maximize space and promote productivity by linking individual stations together and using shared components.



Model numbers to create the above vignette...



SST3084NKG-L (qty 3)
nook workspace - left



SST3084NKG-R (qty 3)
nook workspace - right



SS3018MBBF (qty 6)
executive height
box/box/file pedestal



SSB2430MOS (qty 6)
bench height
open shelf pedestal



SSB2436MSD (qty 6)
bench height
sliding door pedestal



SSB2418MBF (qty 6)
bench height
box/file pedestal



SSB2484MT (qty 6)
modular top



SSK-TOPSPACER2 (qty 6)
spacer to executive height



SSK-BTD2-29 (qty 6)
leg to bench height

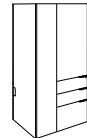

SS2430-60BBFWL (qty 3)
tall storage wardrobe - left

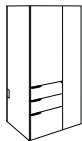

SS2430-60BBFWR (qty 3)
tall storage wardrobe - right

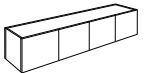

SSI584HD (qty 6)
overhead storage cabinet



SSK-OHSA (qty 6) and
SSK-OHS-D (qty 6)
leg to overhead



EC10 or EC11 (qty 4)
power or power/data unit

Additional idea starters for Forward-Facing Run applications...

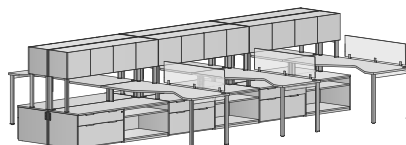
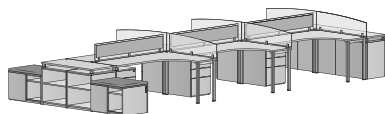

www.swish.jsifurniture.com

Call 800 457 4511 to discuss your project with a JSI Swish expert!



benching

Simple workstations with minimal storage allow coworkers to connect, gather references and recharge for the next project or meeting.



Model numbers to create the above vignette...



SST1860RECTG (qty 2)
rectangle worksurface



SST3060RECTG (qty 4)
rectangle worksurface



SS1830MOS (qty 4)
executive height
open shelf pedestal



SS3018MBBF (qty 4)
executive height
box/box/file pedestal



SSK-TOPSPACER2 (qty 8)
spacer to executive height



SSK-LEG2-29 (qty 4)
leg to floor

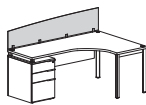

SS1260ASF (qty 2)
fin privacy screen



SS1230ASF (qty 2)
fin privacy screen

Additional idea starter for Benching applications...

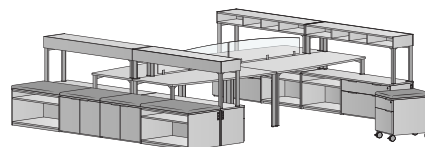
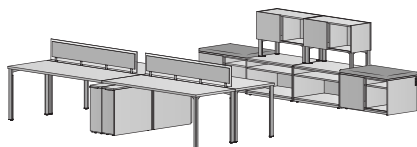



Swish Idea Starters & Work Styles Typical Configurations

private office

Create private spaces with desks, credenzas, L units and U units featuring layered workspaces and storage.



Model numbers to create the above vignette...



SST3678UFINGO-CD
(qty 1)
fin work surface



SS3036MMFEL (qty 1)
executive height
multi-file storage



SSB2430MOS (qty 1)
bench height
open shelf storage



SSB2436MSD (qty 1)
bench height
sliding door storage



SSB2418MBF (qty 1)
bench height
box/file storage



SSB2484MT (qty 1)
modular top



SSK-TOPSPACER2 (qty 1)
spacer to executive height
and **SSK-BTD2-29** (qty 1)
leg to bench height

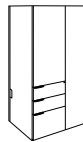

SS2430-60BBFWR (qty 1)
tall storage wardrobe - right

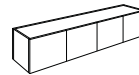

SS1584HD (qty 1)
overhead storage



SSK-OHS-A (qty 1) and
SSK-OHS-D (qty 1)
leg to overhead



SS2424T-17 (qty 1)
square lounge table



SS4242T-23 (qty 1)
square lounge table



SS2448UBBOS (qty 1)
upholstered bench
with open shelf



SS2448UBB (qty 1)
upholstered bench



EC10 or **EC11** (qty 2)
power or power/data unit

Additional idea starters for Private Office applications...

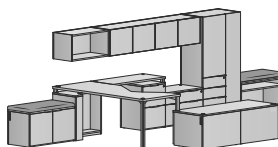
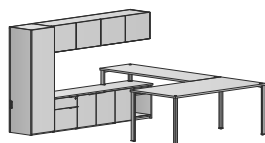

www.swish.jsifurniture.com

Call 800 457 4511 to discuss your project with a JSI Swish expert!



teaming

Encourage open communication and sharing with teammates, while still allowing the ability to work independently.



Model numbers to create the above vignette...



SST1836RECTG (qty 5)
rectangle worksurface



SST3773YG-AA (qty 6)
120° worksurface



SS1818MOS (qty 10)
executive height
open shelf pedestal



SSK-TOPSPACER2 (qty 10)
spacer to executive height



SSK-LEG-2-29 (qty 12)
leg to floor



SSK-LEG1-29 (qty 6)
leg to floor

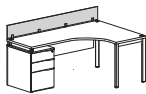

SS0942ASR (qty 6)
rectangle privacy screen



SS3678T-29 (qty 1)
rectangle work table

Additional idea starters for Teaming applications...

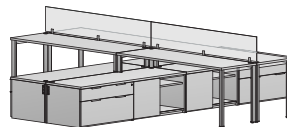
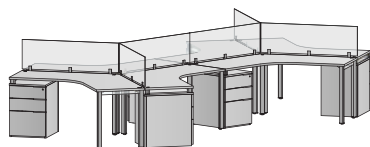



Swish Idea Starters & Work Styles Typical Configurations

conference

Incorporate linking tables, modular storage and integrated seating to support all sizes of meetings and presentations.



Model numbers to create the above vignette...

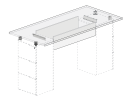

SST3660CCBP (qty 1)
integrated collaboration
conference top



SS1818-38FFF (qty 1)
collaboration conference stand
up table base file/file/file



SS3660CCBL-29 (qty 1)
integrated collaboration
conference table

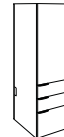

SS1818-54BBFTR (qty 1)
tall storage cabinet
box/box/file - right

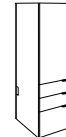

SS1818-54BBFTL (qty 1)
tall storage cabinet
box/box/file - left



SS2130DEB (qty 1)
markerboard



SS2160WHD (qty 1)
wallmount overhead
with cubbies



EC13 (qty 1)
dual power/data unit

Additional idea starters for Conference applications...

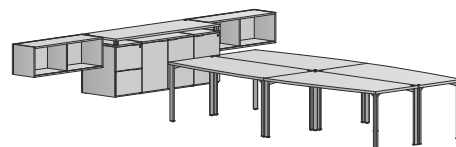
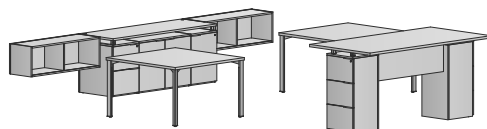

www.swish.jsifurniture.com

Call 800 457 4511 to discuss your project with a JSI Swish expert!



work styles

From collaborative open plan areas to private offices and conferencing spaces, Swish can furnish an entire facility with its robust offering of flexible and functional modular components.

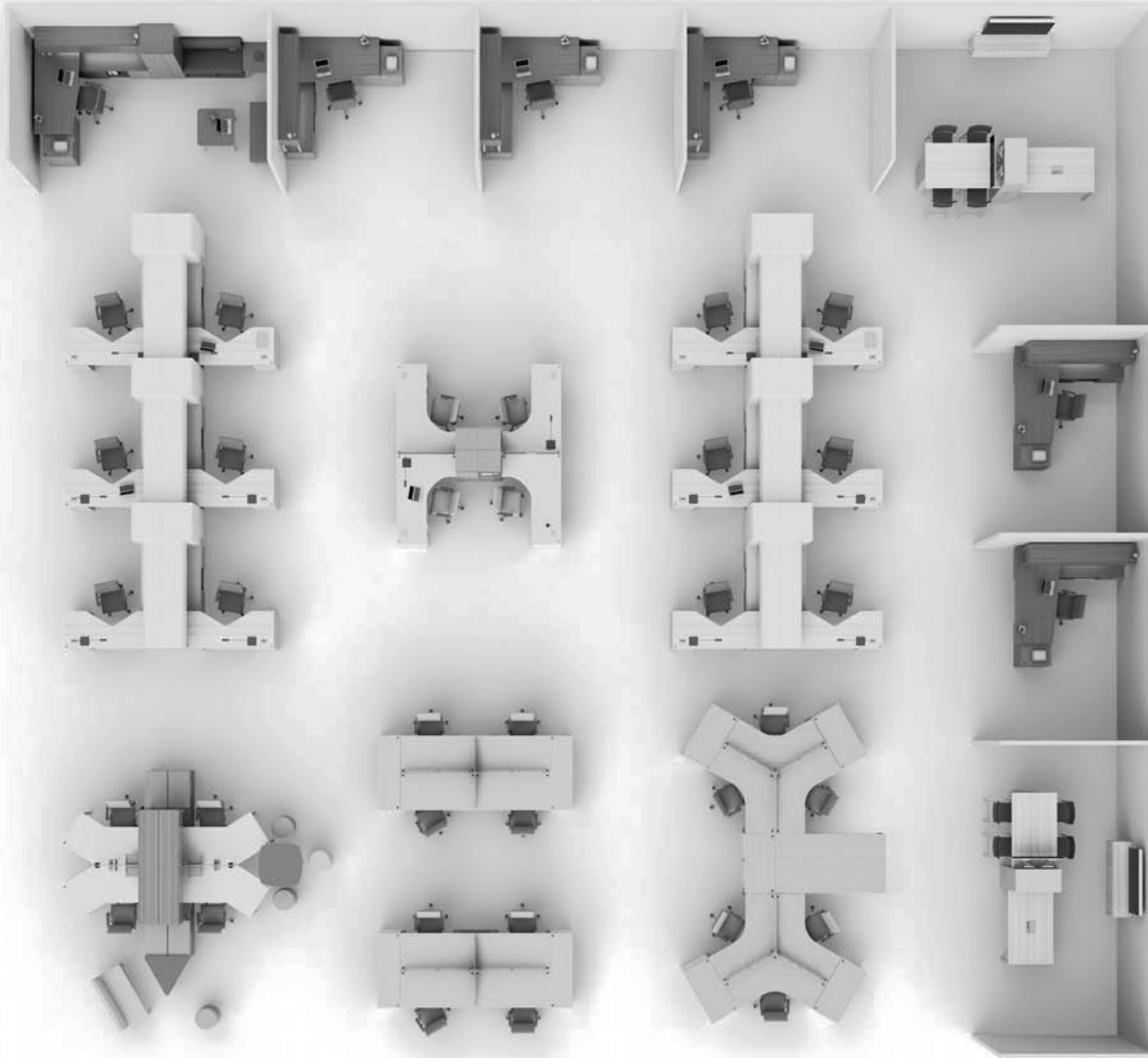



Specifying Swish Additional Steps

surface materials

Choose from a selection of finishes and textures for your Swish configurations...

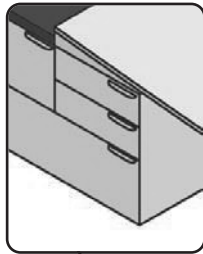

pulls

Drawer pulls can be installed in the left, center or right locations. All drawers and undersurface doors are pre-drilled for easy installation.

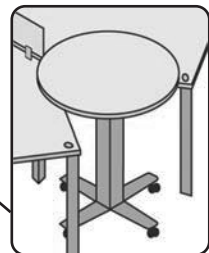
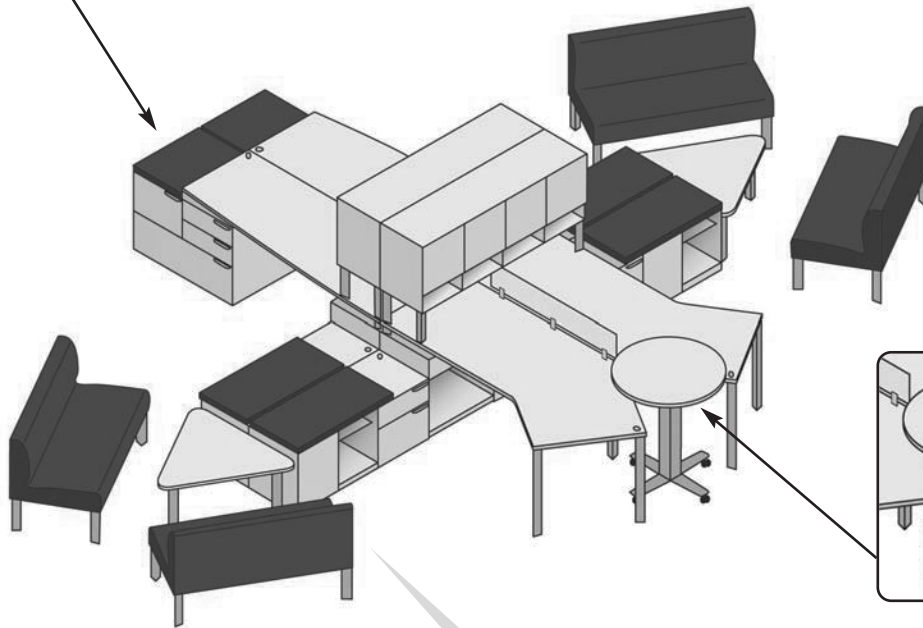

eased PVC edge

Swish worksurfaces and tables feature a coordinating eased PVC edge on all four sides.

TIP! Upholstered benches and cushions are upholstered up the roll, while tackboards are railroaded.

Laminate (woodgrains)



shea



blonde echo

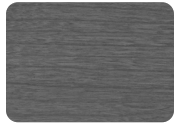

bourbon

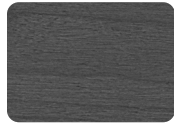

autumn

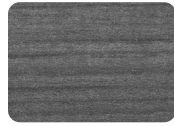

studio teak



graphite



brighton

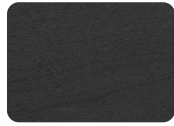

vintage

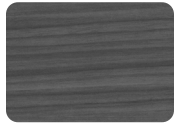

walnut heights

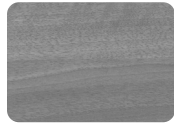

brazilwood

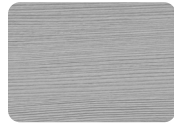

high line

Laminate (solids)

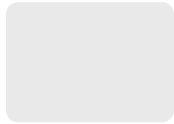

designer white

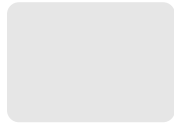

alabaster



bridal blanco



taupe



shadow



dove grey



slate grey

Acrylic



frosted (standard)



drift green (premium)



oyster linen (premium)



paper cut (premium)



ivory taipei (premium)

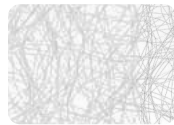

silver spun (premium)

Glass



back painted white

Metal



silver



Product Specifications

Swish Series: Swish has a modular design to allow flexibility in configuration. It features high pressure laminate (HPL) worksurfaces and thermally fused laminate (TFL) chassis components with durable, impact resistant PVC edges. Swish is offered in eleven wood grain colors and seven solid colors. The wood grain TFL features embossed grain to hide fingerprints and light scratches. The Swish offering includes upholstered benches and cushions which integrate with the casegoods.

- Worksurfaces:** Laminate worksurfaces have a 3-ply balanced construction, 1 3/16" thick with coordinating PVC edges. All worksurfaces feature 3mm PVC edge. All edges and corners are eased to eliminate sharp edges. Worksurfaces greater than 48" include a metal support rail to prevent sagging. Worksurfaces also include a 2 1/4" tall frosted acrylic plenum which clips into place below worksurface.
- Power/Data/Wire Management:** Optional 4-wire, one or two circuit undersurface electrical features easy-to-connect fittings which makes routing power a snap. Power & Data tilt-up units are available for worksurfaces in standardized locations. Power & Data units can be plugged into a standard 110v wall outlet or into the undersurface electrical. Teardrop corner grommets and wire management troughs are included standard on all executive height worksurfaces. Bench height, tall storage, executive height corners, and executive height connection pedestals include standard pass through side grommets (1 7/8"W x 3 1/4"H). Worksurfaces are raised 2 1/4" above the top of the executive height pedestals to create space for easy routing of cords and cables. The acrylic plenum then clips in place to hide the cords and adds a decorative element. Also available is a round field installable cable access grommet. Grommet requires a 2 3/8" hole. Overall diameter of the grommet is 2 3/4". Desk legs have a removable acrylic wire management cover which allows passage of cords or flexible electrical through the leg.
- Cabinets:** Laminate chassis is constructed using 3/4" thick thermally fused laminated panels. Exterior panels, doors, drawer fronts have 1mm thick PVC edgebands. Product is designed to minimize the number of exposed fasteners. Cabinets are constructed using metal cam & post connectors along with wood dowels. Wood cleats, pocket screws and metal brackets are also used in desk pedestals where additional joint strength is required. Desk pedestals are standard at 18" wide. Lateral files are available in 30" and 36" width. Leveling glides are installed in a manner to prevent tear-out.
- Drawers:** Drawers are assembled using five sided V-fold box and 1/4" thick drawer bottom panel construction with exterior front attached separately. Maple vinyl sides and drawer bottoms provide a clean, smooth feel and appearance.
- Drawer Suspension:** High quality black drawer suspensions carry a lifetime warranty. File and box drawers have 100% full extension with over-travel. Slides feature steel ball bearings for longer wear and positive, cushioned in/out stops.
- File systems:** All file drawers are constructed with integrated side and back rails and adjustable metal cross rail filing system in place. Cross bars are adjustable and removable without tools.
- Locking:** All drawer pedestals feature pedestal front locking as standard. All hinged door pedestals and non-glass hinged door overhead cabinets are available with optional locking. Units are shipped randomly keyed as standard. Keyed alike units are available at no upcharge with removable cores for in-field re-keying.
- Legs:** Legs and overhead supports are made from extruded aluminum with steel mounting bracket and integrated wire management with cord cover. All legs have adjustable levelers.
- Modesty Panels and Privacy Screens:** Modesty panels and Privacy screens are made of 1/4" thick acrylic. Panels are standard in frosted acrylic. Five premium acrylic patterns are also available. Modesty panels attach to the underside of worksurface with metal brackets. Privacy screens mount with an aluminum bracket which attaches to the bottom edge of the worksurface, therefore installation does not mar the worksurface. The privacy panels are friction fit into the bracket for easy removal of the panel.
- Seating:** Swish seating is designed to integrate with the casegoods to create simple and flexible seating options for the open plan office. Cushions are 1 1/4" thick with slip resistant rubber bumpers on the bottom side and are designed to sit on top of bench height cabinets. Cushions can be easily removed or placed for maximum flexibility. Swish benches are light weight and scaled for use with the series. Cushions and benches use long lasting high density foam and plywood frames. Both are available in multiple fabric grades.

Swish - Overview

Desks

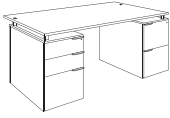

Executive height double pedestal desk with overhang
Page 64

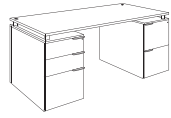

Executive height double pedestal desk
Page 64

Credenzas



Executive height storage credenza
Pages 65-66



Executive height double lateral file credenza
Page 66

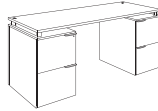

Executive height kneespace credenza
Page 67

Pedestals



Executive height pedestal
Page 68



Mobile pedestal
Page 68



Executive height lateral file
Page 69



Executive height hinged door pedestal
Page 69

Pedestal Desks

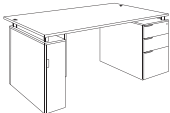

Executive height rectangle single pedestal desk with overhang
Page 70



Executive height rectangle single pedestal desk
Page 71

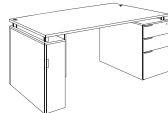

Executive height fin single pedestal desk
Page 72

Return

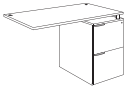

Executive height single pedestal return
Page 73

Swish - Overview

Bridge

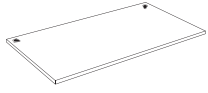

Executive height
bridge
Page 73

Pedestal Credenzas

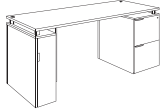

Executive height single
pedestal credenza
Page 74

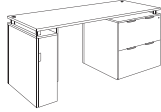

Executive height single
lateral pedestal credenza
Page 75

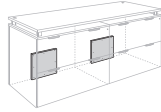

Counterweight
Page 75

Worksurfaces



Rectangle
Grommets - inset 6"
Pages 77-82



Rectangle
Grommets
Pages 83-91



Fin - Arc User Side
Grommets - inset 6"
Pages 92-94



Fin-Arc User Side
Grommets
Pages 95-100

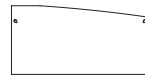

Fin - Arch Approach Side
Grommets
Pages 101-106

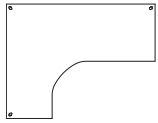

Corner
Grommets
Pages 107-115

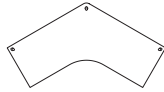

120°
Grommets
Page 116

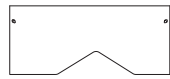

Nook
Grommets - Inset 6"
Page 117

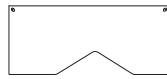

Nook
Grommets
Pages 118-119

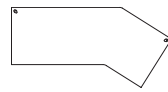

Boomerang
Grommets
Page 120



Return
Grommets
Pages 121-122



Bridge
Grommets
Pages 123-124

Swish - Overview

Modular Executive Height Storage



Box/Box/File
Page 126



File/File
Page 126

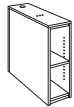

Open storage
Page 126



Hinged door
Page 126

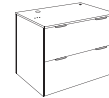

Extended lateral file
Page 127

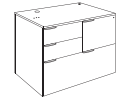

Extended multi-file
Page 127

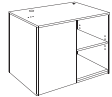

Extended sliding door
Page 127



Connection pedestal
Page 128



Connection pedestal
Page 128



Open corner pedestal
Page 128



Open corner pedestal
Page 128



Hinged door corner pedestal
Page 129



Hinged door corner pedestal
Page 129



Open kneespace corner pedestal
Page 130

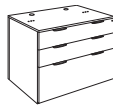

Box/Box/Lateral file
Page 130



Lateral file
Page 130

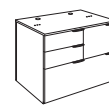

Multi-file
Page 130



Open shelf
Page 131



Open shelf
Page 131



Hinged doors
Page 131



Hinged doors
Page 131

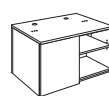

Sliding door
Page 131

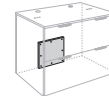

Counterweight
Page 131

Worksurface Supports



Spacer to executive height storage
Pages 132 and 138



Leg to floor
Pages 132 and 138



Leg to bench height
Pages 132 and 138

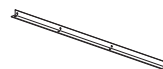

Bracket to tall storage
Pages 132 and 138

Modular Bench Height Storage



Box/Lateral file
Page 134



Box/File
Page 134

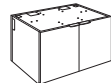

Hinged doors
Page 134



Hinged door
Page 135



Sliding door
Page 135



Open shelf
Page 135



Counterweight
Page 137

Tops for Modular Bench Height Storage

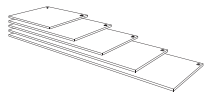

24" deep modular top for bench height
Page 136

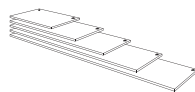

18" deep modular top for bench height
Page 137

Swish - Overview

Tall Storage

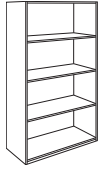

Bookcase
Page 140



Storage cabinet
Page 141

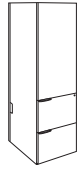

Storage cabinet
Page 142

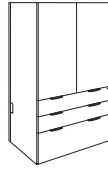

Storage cabinet
Pages 143-144

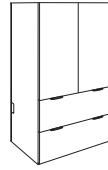

Storage cabinet
Page 144



Storage cabinet
with side access
Page 145



Storage wardrobe
Pages 145-146



Storage wardrobe
Page 146

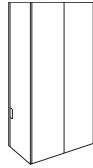

Double door
storage cabinet
Page 147

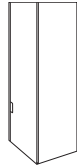

Single door
storage cabinet
Page 148



Counterweight
Page 148

Above Surface Storage Transaction Top

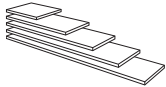

Transaction top
Page 150

Above Surface Storage

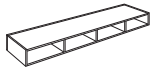

Horizontal cubby
organizer
Page 150

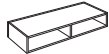

Horizontal cubby
organizer
Page 150

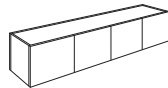

Storage overhead
cabinet
Page 151

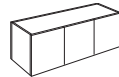

Storage overhead
cabinet
Page 151

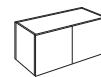

Storage overhead
cabinet
Page 151

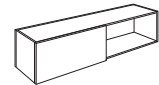

Storage overhead
cabinet sliding door
Page 152

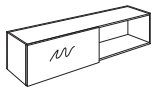

Storage overhead
cabinet sliding
markerboard door
Page 152

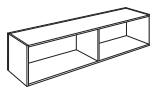

Storage open
overhead cabinet
Page 153

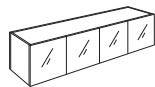

Glass storage
overhead cabinet
Page 153

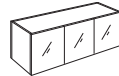

Glass storage
overhead cabinet
Page 154

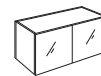

Glass storage
overhead cabinet
Page 154

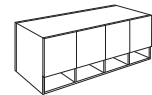

Storage overhead
cabinet with cubby
below
Page 154

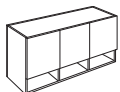

Storage overhead
cabinet with cubby
below
Page 154

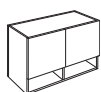

Storage overhead
cabinet with cubby
below
Page 154

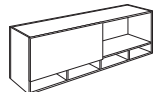

Storage overhead
cabinet sliding door
with cubby below
Page 155

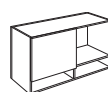

Storage overhead
cabinet sliding door
with cubby below
Page 155



Storage overhead
cabinet sliding
markerboard door with
cubby below
Page 155

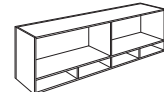

Storage open
overhead cabinet with
cubby below
Page 156



Storage open
overhead cabinet with
cubby below
Page 156

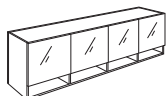

Glass storage
overhead cabinet with
cubby below
Page 156

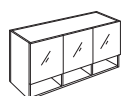

Glass storage
overhead cabinet with
cubby below
Page 157





Glass storage
overhead cabinet with
cubby below
Page 157

Swish - Overview

Above Surface Storage Supports - From Executive Height

- 

Support for transaction top, cubby, 15" H overhead and 21" H overhead
Page 158
- 

Support for transaction top and 15" H overhead
Page 158
- 

Support for cubby
Page 158

Above Surface Storage Supports - From Bench Height

- 

Support for transaction top, cubby, 15" H overhead and 21" H overhead
Page 159-160
- 

Support for transaction top and 15" H overhead
Page 159-160
- 

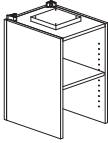
Support for transaction top, cubby, 15" H overhead and 21" H overhead
Page 159-160
- 

Support for transaction top and 15" H overhead
Page 159-160
- 

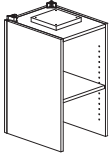
Support for cubby
Page 159-160
- 

Support for cubby
Page 159-160

Above Surface Storage

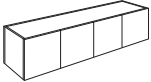
- 

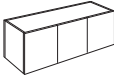
Wall mount overhead cabinet
Page 161
- 

Wall mount overhead cabinet
Page 161
- 

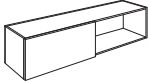
Wall mount overhead cabinet
Page 161
- 

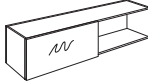
Wall mount overhead cabinet sliding door
Page 161
- 

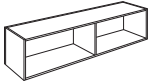
Wall mount overhead cabinet sliding markerboard door
Page 162
- 

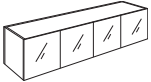
Wall mount open overhead cabinet
Page 162
- 

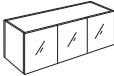
Glass wall mount overhead cabinet
Page 162
- 

Glass wall mount overhead cabinet
Page 163
- 

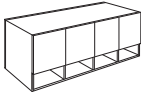
Glass wall mount overhead cabinet
Page 163
- 

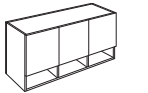
Wall mount overhead cabinet with cubby below
Page 163
- 

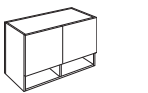
Wall mount overhead cabinet with cubby below
Page 163
- 

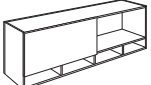
Wall mount overhead cabinet with cubby below
Page 163
- 

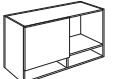
Wall mount overhead cabinet sliding door with cubby below
Page 164
- 

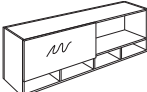
Wall mount overhead cabinet sliding door with cubby below
Page 164
- 

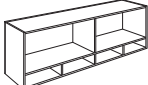
Wall mount overhead cabinet sliding markerboard door with cubby below
Page 164
- 

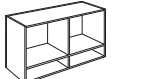
Wall mount open overhead cabinet with cubby below
Page 164
- 

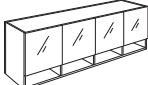
Wall mount open overhead cabinet with cubby below
Page 164
- 

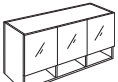
Glass wall mount overhead cabinet with cubby below
Page 165
- 

Glass wall mount overhead cabinet with cubby below
Page 165
- 

Glass wall mount overhead cabinet with cubby below
Page 165

Swish - Overview

Accessories

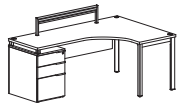

Accessory rail
(post mount)
Page 168



Upright tray
Page 169



Small tray
Page 169

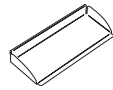

Pencil tray
Page 169

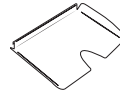

Paper tray
Page 169

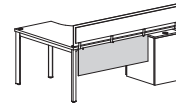

15" high modesty
panel
Page 170

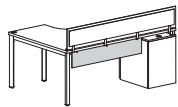

9" high modesty
panel
Page 171

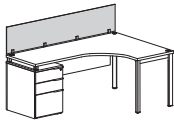

15" high rectangle
privacy screen
Page 172

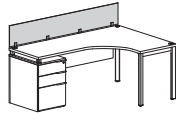

12" high rectangle
privacy screen
Page 172

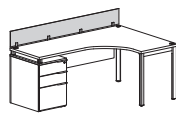

9" high rectangle
privacy screen
Page 173

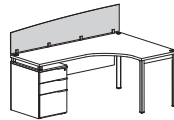

15" high fin privacy
screen
Page 174

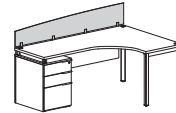

12" high fin privacy
screen
Page 174

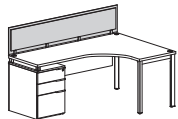

15" high rectangle
privacy screen
with tackboard
Pages 175-176

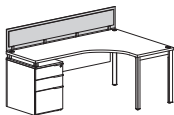

12" high rectangle
privacy screen
with tackboard
Pages 177-178

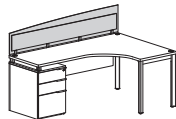

15" high fin privacy
screen with
tackboard
Pages 179-180



Markerboard for
back of tall storage
Pages 181-182

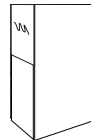

Markerboard for
side of tall storage
Page 183

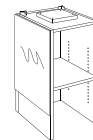

Markerboard for side
of side access storage
Page 184



Markerboard for back
of 15" high overhead
Page 185



Markerboard for back
of 21" high overhead
Page 185

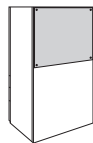

Tackboard for back
of tall storage
Pages 186-187

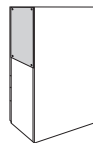

Tackboard for side
of tall storage
Pages 188- 189

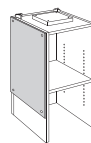

Tackboard for side
of side access storage
Page 189

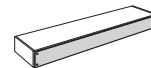

Tackboard for back
of cubby
Pages 190-191

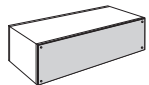

Tackboard for back
of 15" High Overhead
Pages 192-193

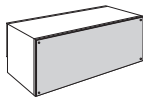

Tackboard for back
of 21" High Overhead
Pages 194-195

Swish - Overview

Collaborate

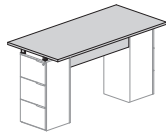

Collaboration conference top
Page 197

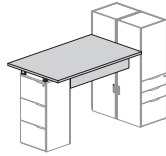

Integrated collaboration conference top
Pages 198-200



Stand up height collaboration table base
Page 201



Stand up height collaboration table base
Page 201

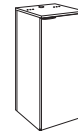

Stand up height collaboration table base
Page 201

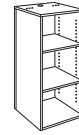

Stand up height collaboration table base
Page 201



Executive height Box/Box/File
Page 201



Executive height File/File
Page 201

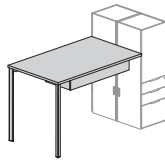

Integrated collaboration conference table - stand up height
Pages 202-203

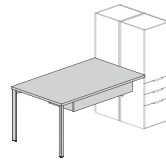

Integrated collaboration conference table - executive height
Pages 204-205



Work table
Page 206



Squircle pneumatic adjustable height table
Page 207



Squircle ratcheting adjustable height table
Page 207



Squircle pneumatic adjustable height table with casters
Page 207



Squircle ratcheting adjustable height table with casters
Page 207



Round pneumatic adjustable height table
Page 208



Round ratcheting adjustable height table
Page 208



Round pneumatic adjustable height table with casters
Page 208



Round ratcheting adjustable height table with casters
Page 208

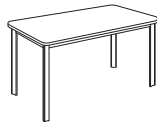

Rectangular lounge table
Page 209



Square lounge table
Page 209



Triangular lounge table
Page 209

Collaborate

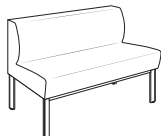

Lounge seating
Page 210

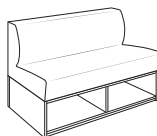

Lounge seating with open shelf
Page 211

Mobile Pedestal



Mobile pedestal
Page 212

Swish - Overview

Seat Cushions

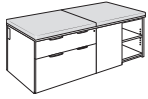

24" deep seat cushions
Page 212

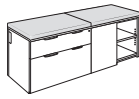

18" deep seat cushion
Page 213

Power and Data



Mini grommet power and data tilt up
Page 214



Mini power tilt up
Page 214



Mini power and USB tilt up
Page 214



Dual power and data tilt up
Page 214

Undersurface Electrical

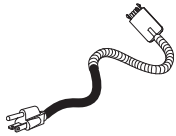

Three prong power infeed-flex metallic conduit
Page 215

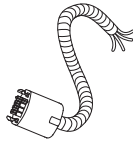

Hardwire power infeed-flex metallic conduit
Page 215

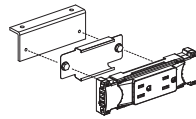

Dulex receptacle kit circuit
Page 215



Receptacle to receptacle connector
Page 215



H block connector kit
Page 215



Jumper
Page 216

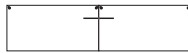

End to end jumper
Page 216

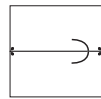

Back to back jumper
Page 217

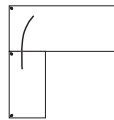

Bridge and return jumper
Page 217



Vertical jumper
Page 217



Conduit clamp
Page 217

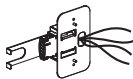

Quick disconnect
Page 217



Round grommet
Page 217

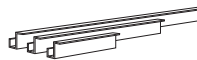

Wire management trough
Page 217

SS0100 Back to Back

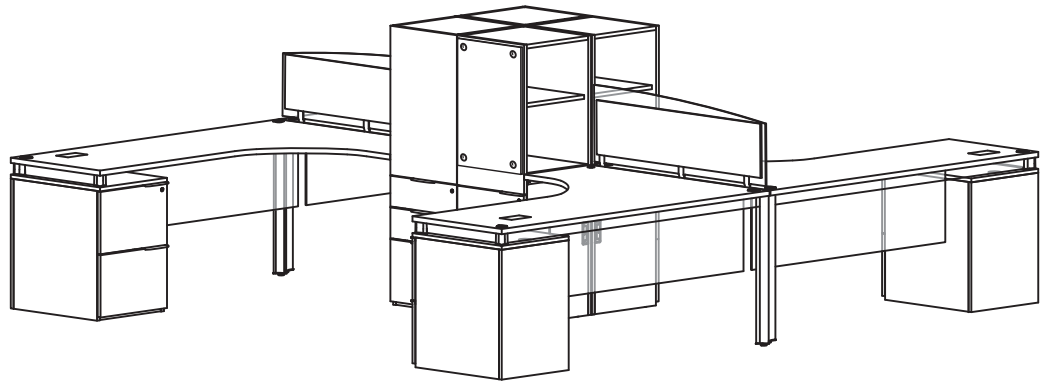
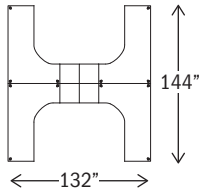

Total List **\$21,666**
List Per User **\$5,417**

Models

- | | | |
|-----------------------|----------------------|------------------|
| (2) SST4872CRNRG-AB-R | (2) SS1818-54BBFSSTL | (2) SS2117TK |
| (2) SST4872CRNRG-BA-L | (2) SS1818-54BBFSSTR | (4) SSK-LEG1-29 |
| (4) SS2418MFF | (4) SS1552AMR | (4) SSK-LBRKT-18 |
| (4) SSK-TOPSPACER2 | (2) SS1548ASF-TK2 | (4) EC11 |

SWISH

SS0101 Back to Back

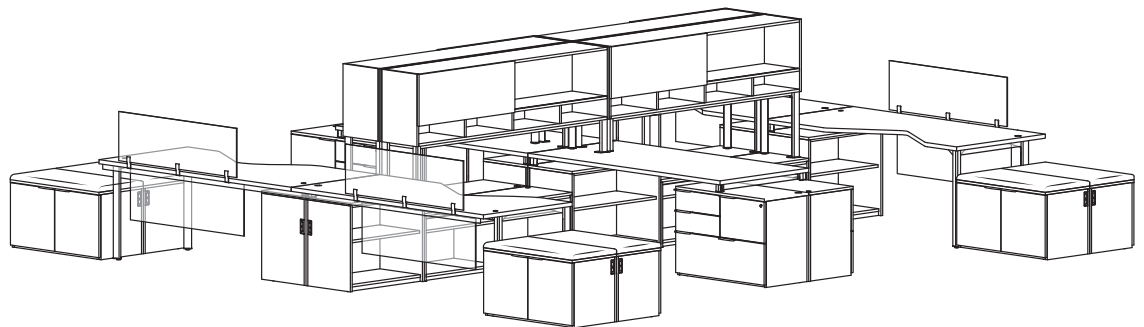
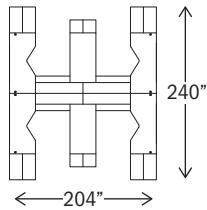

Total List **\$44,590**
List Per User **\$11,148**

Models

- | | | |
|-------------------|--------------------|----------------|
| (2) SST3684NKGO-L | (2) SS1836MMFER | (8) SS1836CUSH |
| (2) SST3684NKGO-R | (2) SS1836MMFEL | (4) SS2166SD |
| (2) SST3684RECTG | (4) SSK-LEG2-29 | (4) SSK-OHS-A |
| (2) SS2436MRO | (8) SSK-TOPSPACER2 | (4) SSK-OHS-D |
| (4) SS2430MRO | (8) SSB1836MHD | (4) SS1561AMR |
| (8) SSB2424MOS | (8) SSB1836MT | (4) SS1560ASR |
| (4) SSB2448MT | | |

SS0201 Integrated Collaboration

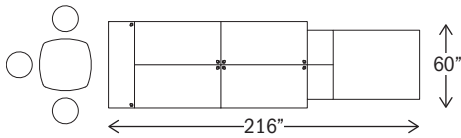
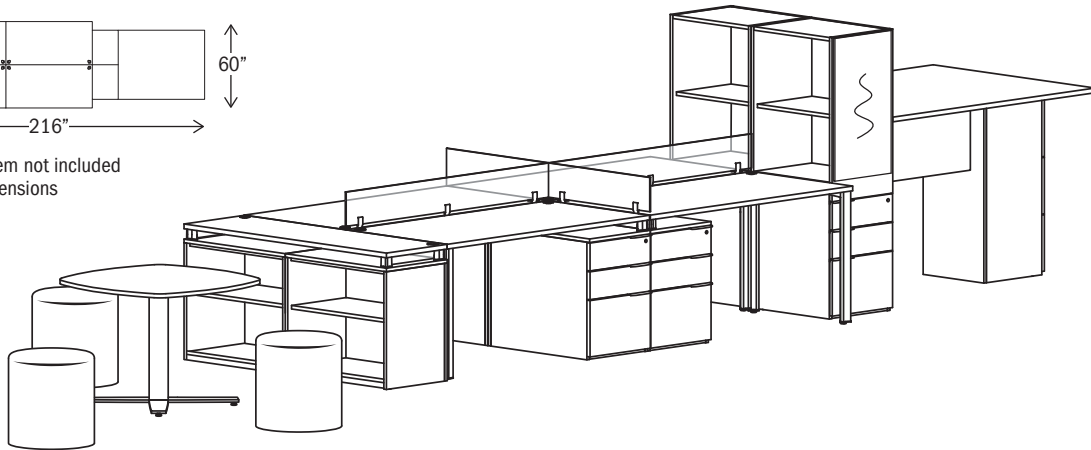

Table and Totem not included in overall dimensions



SWISH

Total List **\$19,557**
List Per User **\$4,890**

Models

(4) SST3060RECTG	(1) SS2418-54BBFSSTL	(1) SS36SQCL-PN
(4) SS3618MBBF	(2) SS2117DEB	(3) TM17R
(4) SSK-LEG2-29	(2) SS1830MOS	(1) SST4860CCBP
(4) SSK-TOPSPACER2	(1) SST1860RECTG	(1) SS1818-38FFF
(1) SS2418-54BBFSSTR	(2) SSK-TOPSPACER2	

SS0203 Integrated Collaboration

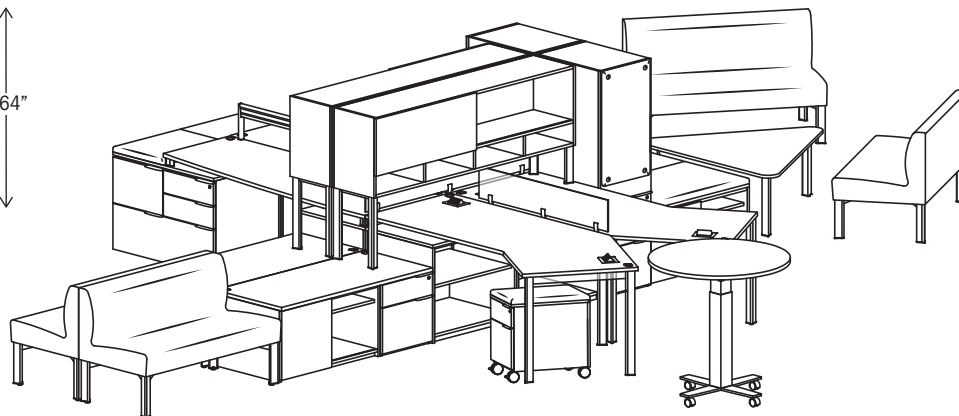
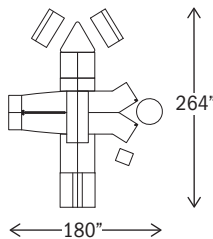

Total List **\$38,686**
List Per User **\$9,672**

Models

(1) SST3078UFING-BC	(2) SSB2454MT	(2) SS2172SD	(4) EC10
(1) SST3078UFING-CB	(2) SSB2436MT	(2) SSK-OHS-A	
(1) SST3084BMG-R	(4) SS2430MRO	(2) SSK-OHS-D	
(1) SST3084BMG-L	(3) SSK-LEG2-29	(1) SS0958AR	
(1) SS2436MMFEL	(6) SSK-TOPSPACER2	(1) SS0954ASR	
(1) SS2436MMFER	(1) SS2418-60BBFSSTL	(1) SS2018MP	
(2) SS1824CUSH	(1) SS2418-60BBFSSTR	(1) SS36ROUN-PN-CAST	
(4) SSB2436MSD	(2) SS2717TK	(4) SS2448UBB	
(2) SSB2418MBF	(2) SS2436CUSH	(1) SS48TRI-23	

SS0301 Forward-Facing Run

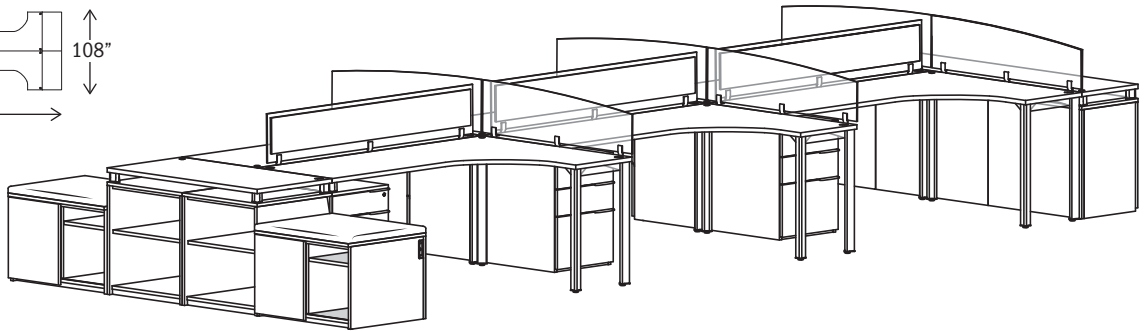
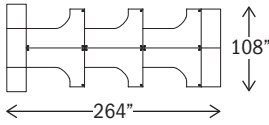

Total List **\$33,661**
List Per User **\$5,611**

Models

- | | | |
|-----------------------|--------------------|--------------------|
| (3) SST4872CRNRG-BA-L | (1) SST2448RECTG | (1) SS2436MOS |
| (3) SST4872CRNRG-AB-R | (2) SSK-TOPSPACER2 | (1) SST2496RECTG |
| (6) SS2418MBBF | (2) SSB2430MSD | (2) SSK-TOPSPACER2 |
| (9) SSK-LEG2-29 | (2) SSB2430MT | (3) SS1572ASR-TK2 |
| (6) SSK-TOPSPACER2 | (2) SS2430CUSH | (6) SS1548ASF |
| (2) SS2424MRO | (2) SS2430MSD | |

SS0302 Forward-Facing Run

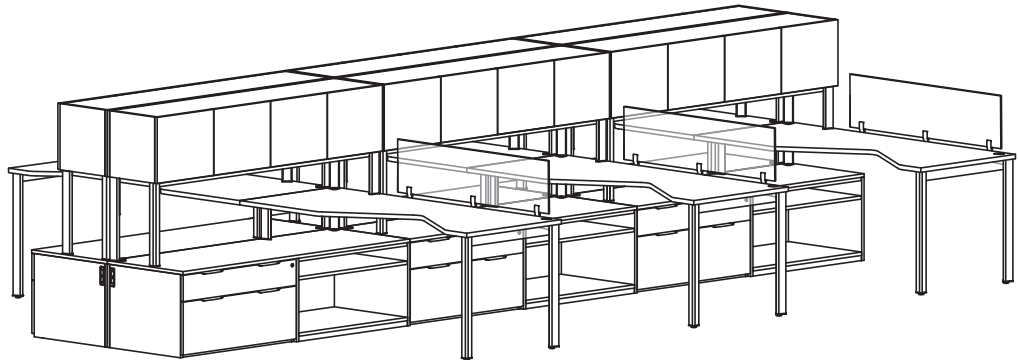
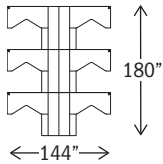

Total List **\$32,208**
List Per User **\$5,368**

Models

- | | | |
|------------------|-----------------|---------------|
| (3) SST3072NKG-R | (6) SSB2460MT | (6) SSK-OHS-D |
| (3) SST3072NKG-L | (6) SSK-LEG2-29 | (6) SSK-OHS-A |
| (6) SSB2430MBF | (6) SSK-BTD2-29 | (6) SS1548ASR |
| (6) SSB2430MOS | (6) SS1560HD | |

SS0401 Benching

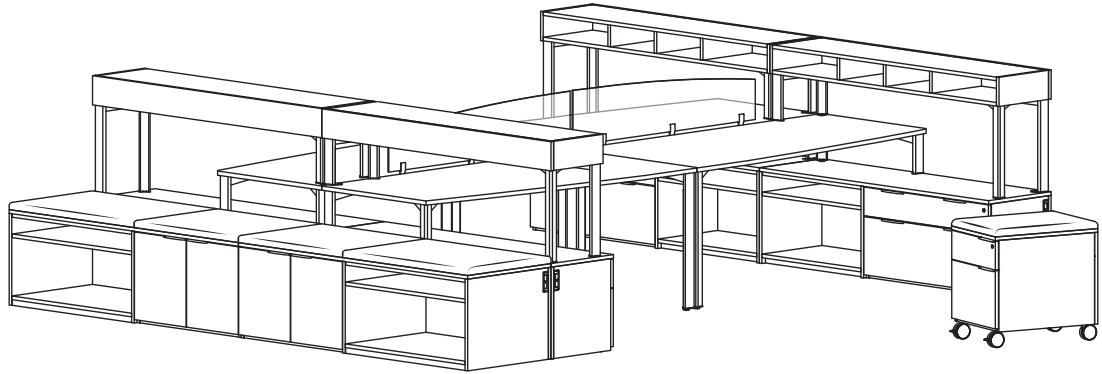
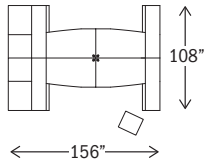

SWISH

Total List **\$23,928**
List Per User **\$5,982**

Models

(2) SST3066UFING-BC	(4) SSK-BTD2-29	(4) SS0654CU
(2) SST3066UFING-CB	(2) SSB2430MOS	(4) SSK-OHS-F
(4) SSB1830MBF	(2) SSB2424MHD	(4) SSK-OHS-C
(4) SSB1824MOS	(1) SSB24108MT	(2) SS1548ASF
(4) SSB1854MT	(2) SS2430CUSH	(1) SS2018MP
(4) SSK-LEG2-29	(2) SS2424CUSH	

SS0501 Private Office

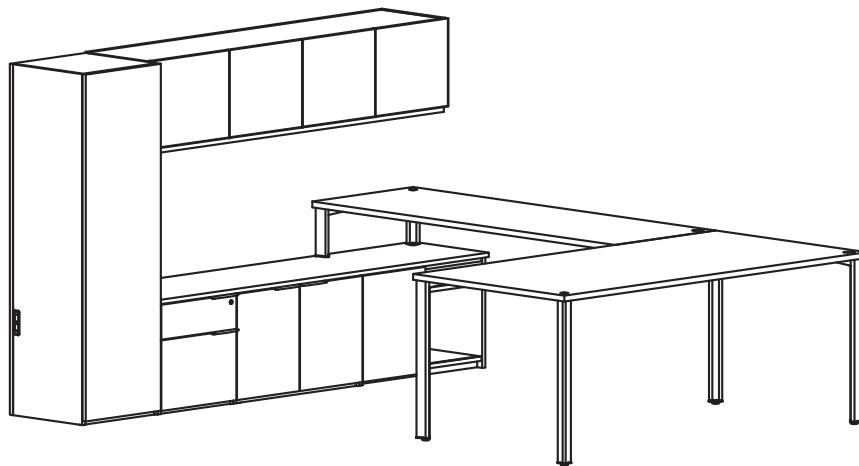
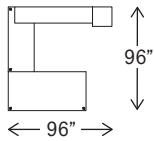

List Price **\$6,820**

Models

(1) SST3672RECTG	(1) SSB1830MSD	(2) SSK-LEG2-29
(1) SST6024RTRNG-L	(1) SSB1878MT	(1) SS1818-60HL
(1) SSB1818MBF	(1) SSK-BTD2-29	(1) SS1572WHD
(1) SSB1830MHD		

SS0502 Private Office

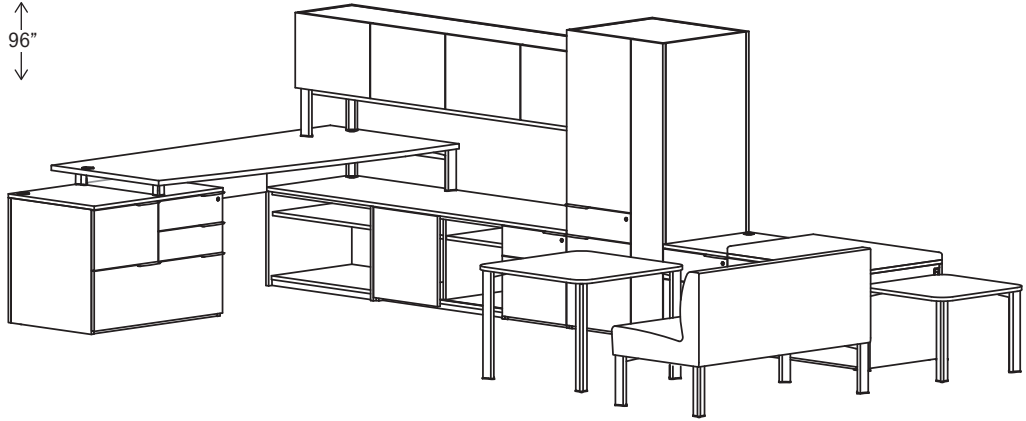
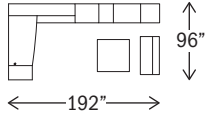

Total List **\$14,691**

Models

- | | | |
|----------------------|--------------------|----------------|
| (1) SST3678UFINGO-CD | (1) SSK-BTD2-29 | (1) SS20LB |
| (1) SS3036MMFEL | (1) SS1584HD | (1) SSB2436MBF |
| (1) SSB2430MOS | (1) SSK-OHS-A | (1) SSB2454MT |
| (1) SSB2436MSD | (1) SSK-OHS-D | (1) SS2436CUSH |
| (1) SSB2418MBF | (1) SS2430-60BBFWR | (1) SS2424T-17 |
| (1) SSB2484MT | (1) SSB2418MBF | (1) SS4242T-23 |
| (1) SSK-TOPSPACER2 | (1) SS10LB | (1) SS2448UBB |

SS0601 Teaming

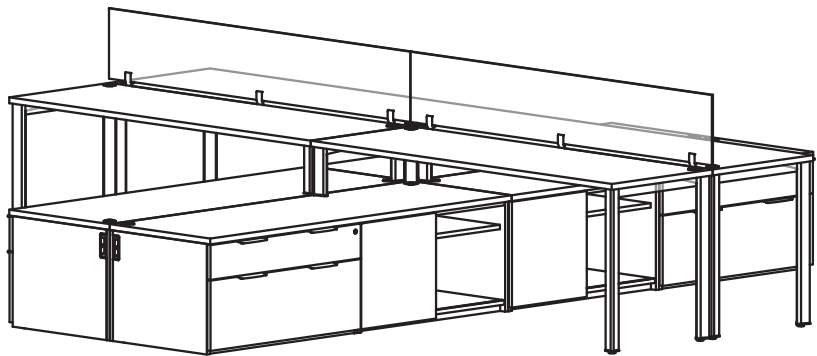
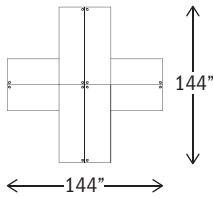

Total List **\$14,578**
List Per User **\$3,645**

Models

- | | | |
|------------------|-----------------|-----------------|
| (4) SST2472RECTG | (4) SSB2472MT | (4) SSK-BTD2-29 |
| (4) SSB2436MBF | (4) SSK-LEG2-29 | (2) SS1272ASR |
| (4) SSB2436MSD | | |

SWISH

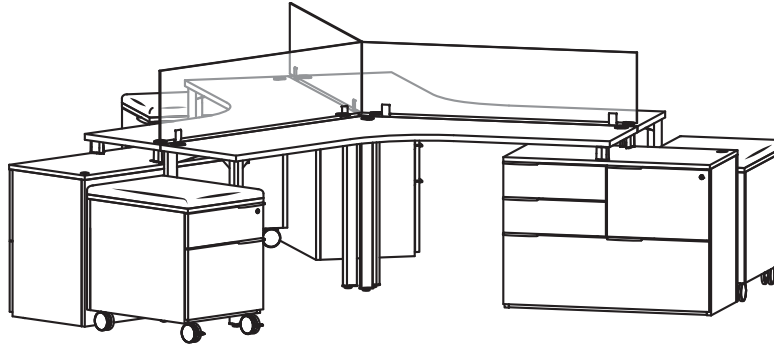
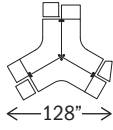
SS0602 Teaming**Models**

Total List **\$16,404**
List Per User **\$5,468**

- (3) SST4584YG-BB
- (3) SS2436MMFER
- (3) SSK-TOPSPACER2
- (3) SSK-LEG2-29
- (3) SSK-LEG1-29
- (3) SS2018MP
- (3) SS1548ASR

Interior Drawer Dimensions

Double Pedestal Desks		Drawer Arrangement			
Model	Description	User Left	User Right		
SS3672ED	Double Pedestal Desk w/Overhang	Box/Box/File	File/File		
SS3666ED	Double Pedestal Desk w/Overhang	Box/Box/File	File/File		
SS3072DD	Double Pedestal Desk	Box/Box/File	File/File		
SS3066DD	Double Pedestal Desk	Box/Box/File	File/File		
Drawer Dimensions		Inside Depth	Inside Width	Inside Height	File Capability
Box 1		21	14 ⁵ / ₁₆	2 ¹ / ₄	N/A
Box 2		21	14 ⁵ / ₁₆	3 ¹ / ₄	N/A
File		21	14 ⁵ / ₁₆	9 ¹ / ₈	Letter Filing Front to Back; Legal or Letter Filing Side to Side

24" Deep Storage and Kneespace Credenzas		Drawer Arrangement			
Model	Description	User Left	User Right		
SS2472SCHD	Storage Credenza	File/File	File/File		
SS2466SCHD	Storage Credenza	File/File	File/File		
SS2472KC	Kneespace Credenza	File/File	File/File		
SS2466KC	Kneespace Credenza	File/File	File/File		
Drawer Dimensions		Inside Depth	Inside Width	Inside Height	File Capability
File		15	14 ⁵ / ₁₆	9 ¹ / ₈	Letter Filing Front to Back; Legal or Letter Filing Side to Side

18" Deep Storage and Kneespace Credenzas		Drawer Arrangement			
Model	Description	User Left	User Right		
SS1872SCHD	Storage Credenza	File/File	File/File		
SS1866SCHD	Storage Credenza	File/File	File/File		
SS1872KC	Kneespace Credenza	File/File	File/File		
SS1866KC	Kneespace Credenza	File/File	File/File		
Drawer Dimensions		Inside Depth	Inside Width	Inside Height	File Capability
File		12	14 ⁵ / ₁₆	9 ¹ / ₈	Letter Filing Front to Back; Letter Filing Side to Side

Single Pedestal Desks		Drawer Arrangement			
Model	Description	User Left	User Right		
SS3672RED	Right Ped Overhang Desk	—	Box/Box/File		
SS3672LED	Left Ped Overhang Desk	Box/Box/File	—		
SS3072RED	Right Ped Overhang Desk	—	Box/Box/File		
SS3072LED	Left Ped Overhang Desk	Box/Box/File	—		
SS3666RED	Right Ped Overhang Desk	—	Box/Box/File		
SS3666LED	Left Ped Overhang Desk	Box/Box/File	—		
SS3066RED	Right Ped Overhang Desk	—	Box/Box/File		
SS3066LED	Left Ped Overhang Desk	Box/Box/File	—		
SS3072RD	Right Ped Desk	—	Box/Box/File		
SS3072LD	Left Ped Desk	Box/Box/File	—		
SS3066RD	Right Ped Desk	—	Box/Box/File		
SS3066LD	Left Ped Desk	Box/Box/File	—		
SS3060RD	Right Ped Desk	—	Box/Box/File		
SS3060LD	Left Ped Desk	Box/Box/File	—		
SS3672RFD	Right Ped Fin Ped Desk	—	Box/Box/File		
SS3672LFD	Left Ped Fin Ped Desk	Box/Box/File	—		
SS3072RFD	Right Ped Fin Ped Desk	—	Box/Box/File		
SS3072LFD	Left Ped Fin Ped Desk	Box/Box/File	—		
SS3666RFD	Right Ped Fin Ped Desk	—	Box/Box/File		
SS3666LFD	Left Ped Fin Ped Desk	Box/Box/File	—		
SS3066RFD	Right Ped Fin Ped Desk	—	Box/Box/File		
SS3066LFD	Left Ped Fin Ped Desk	Box/Box/File	—		
Drawer Dimensions		Inside Depth	Inside Width	Inside Height	File Capability
Box 1		21	14 ⁵ / ₁₆	2 ¹ / ₄	N/A
Box 2		21	14 ⁵ / ₁₆	3 ¹ / ₄	N/A
File		21	14 ⁵ / ₁₆	9 ¹ / ₈	Letter Filing Front to Back; Legal or Letter Filing Side to Side

Interior Drawer Dimensions

24" Deep Single Pedestal Credenzas		Drawer Arrangement			
Model	Description	User Left	User Right		
SS2472RC	Right Ped Credenza	—	File/File		
SS2472LC	Left Ped Credenza	File/File	—		
SS2466RC	Right Ped Credenza	—	File/File		
SS2466LC	Left Ped Credenza	File/File	—		
SS2472LRC	Right Lateral File Credenza	—	Lat File/Lat File		
SS2472LLC	Left Lateral File Credenza	Lat File/Lat File	—		
SS2466LRC	Right Lateral File Credenza	—	Lat File/Lat File		
SS2466LLC	Left Lateral File Credenza	Lat File/Lat File	—		
Drawer Dimensions		Inside Depth	Inside Width	Inside Height	File Capability
File		15	14 ⁵ / ₁₆	9 ¹ / ₈	Letter Filing Front to Back; Legal or Letter Filing Side to Side
Lat File		15	26 ⁵ / ₁₆	9 ¹ / ₈	Double Legal or Letter Filing Front to Back; Legal Filing Side to Side

18" Deep Single Pedestal Credenzas		Drawer Arrangement			
Model	Description	User Left	User Right		
SS1872RC	Right Ped Credenza	—	File/File		
SS1872LC	Left Ped Credenza	File/File	—		
SS1866RC	Right Ped Credenza	—	File/File		
SS1866LC	Left Ped Credenza	File/File	—		
SS1860RC	Right Ped Credenza	—	File/File		
SS1860LC	Left Ped Credenza	File/File	—		
SS1872LRC	Right Lateral File Credenza	—	Lat File/Lat File		
SS1872LLC	Left Lateral File Credenza	Lat File/Lat File	—		
SS1866LRC	Right Lateral File Credenza	—	Lat File/Lat File		
SS1866LLC	Left Lateral File Credenza	Lat File/Lat File	—		
SS1860LRC	Right Lateral File Credenza	—	Lat File/Lat File		
SS1860LLC	Left Lateral File Credenza	Lat File/Lat File	—		
Drawer Dimensions		Inside Depth	Inside Width	Inside Height	File Capability
File		12	14 ⁵ / ₁₆	9 ¹ / ₈	Letter Filing Front to Back; Legal or Letter Filing Side to Side
Lat File		12	26 ⁵ / ₁₆	9 ¹ / ₈	Double Legal or Letter Filing Front to Back; Letter Filing Side to Side

24" Deep Executive Returns		Drawer Arrangement			
Model	Description	User Left	User Right		
SS2448ERR	Right Executive Return	—	File/File		
SS2448ELR	Left Executive Return	File/File	—		
SS2442ERR	Right Executive Return	—	File/File		
SS2442ELR	Left Executive Return	File/File	—		
Drawer Dimensions		Inside Depth	Inside Width	Inside Height	File Capability
File		15	14 ⁵ / ₁₆	9 ¹ / ₈	Letter Filing Front to Back; Legal Filing Side to Side

18" Deep Executive Returns		Drawer Arrangement			
Model	Description	User Left	User Right		
SS1848ERR	Right Executive Return	—	File/File		
SS1848ELR	Left Executive Return	File/File	—		
SS1842ERR	Right Executive Return	—	File/File		
SS1842ELR	Left Executive Return	File/File	—		
Drawer Dimensions		Inside Depth	Inside Width	Inside Height	File Capability
File		12	14 ⁵ / ₁₆	9 ¹ / ₈	Letter Filing Front to Back; Letter Filing Side to Side

Lateral Files - 36" Wide		Drawer Arrangement			
Model	Description				
SS2436LF	Lateral File	(2) Lateral File			
SS2472LFC	Lateral File	User Left Lat File/Lat File	User Right Lat File/Lat File		
Drawer Dimensions		Inside Depth	Inside Width	Inside Height	File Capability
Lat File		15	32 ⁵ / ₁₆	9 ¹ / ₈	Double Legal or Letter Filing Front to Back; Legal Filing Side to Side

SWISH

Interior Drawer Dimensions

Lateral Files - 30" Wide

Model	Description	Drawer Arrangement				File Capability
SS2430LF	Lateral File	(2) Lateral File				
			User Left	User Right		
			Lat File/Lat File	Lat File/Lat File		
SS2460LFC	Lateral File					
		Drawer Dimensions	Inside Depth	Inside Width	Inside Height	File Capability
		Lat File	15	26 ⁵ / ₁₆	9 ¹ / ₈	Double Letter Filing Front to Back; Legal Filing Side to Side

Modular Desk Pedestals

Model	Description	Drawer Arrangement				File Capability
SS3018MBBF	Modular Pedestal	Box/Box/File				
SS3018MFF	Modular Pedestal	File/File				
		Drawer Dimensions	Inside Depth	Inside Width	Inside Height	File Capability
	Box 1		21	14 ⁵ / ₁₆	2 ³ / ₄	N/A
	Box 2		21	14 ⁵ / ₁₆	3 ¹ / ₄	N/A
	File		21	14 ⁵ / ₁₆	9 ¹ / ₈	Letter Filing Front to Back; Legal or Letter Filing Side to Side

24" Deep Modular Credenza Pedestals

Model	Description	Drawer Arrangement				File Capability
SS2418MBBF	Modular Pedestal	Box/Box/File				
SS2418MFF	Modular Pedestal	File/File				
		Drawer Dimensions	Inside Depth	Inside Width	Inside Height	File Capability
	Box 1		15	14 ⁵ / ₁₆	2 ³ / ₄	N/A
	Box 2		15	14 ⁵ / ₁₆	3 ¹ / ₄	N/A
	File		15	14 ⁵ / ₁₆	9 ¹ / ₈	Letter Filing Front to Back; Legal or Letter Filing Side to Side

18" Deep Modular Credenza Pedestals

Model	Description	Drawer Arrangement				File Capability
SS1818MBBF	Modular Pedestal	Box/Box/File				
SS1818MFF	Modular Pedestal	File/File				
		Drawer Dimensions	Inside Depth	Inside Width	Inside Height	File Capability
	Box 1		12	14 ⁵ / ₁₆	2 ³ / ₄	N/A
	Box 2		12	14 ⁵ / ₁₆	3 ¹ / ₄	N/A
	File		12	14 ⁵ / ₁₆	9 ¹ / ₈	Letter Filing Front to Back; Letter Filing Side to Side

24" Deep Modular Lateral File Pedestals - 36" Wide

Model	Description	Drawer Arrangement				File Capability
SS2436MLF	Modular Lateral File Pedestal	Lat File/Lat File				
SS2436MLFER	Extended Modular Lateral File Pedestal	Lat File/Lat File				
SS2436MLFEL	Extended Modular Lateral File Pedestal	Lat File/Lat File				
		Drawer Dimensions	Inside Depth	Inside Width	Inside Height	File Capability
	Lat File		15	32 ⁵ / ₁₆	9 ¹ / ₈	Double Legal or Letter Filing Front to Back; Legal Filing Side to Side

24" Deep Modular Lateral File Pedestals - 30" Wide

Model	Description	Drawer Arrangement				File Capability
SS2430MLF	Modular Lateral File Pedestal	Lat File/Lat File				
		Drawer Dimensions	Inside Depth	Inside Width	Inside Height	File Capability
	Lat File		15	26 ⁵ / ₁₆	9 ¹ / ₈	Double Letter Filing Front to Back; Legal Filing Side to Side

18" Deep Modular Lateral File Pedestals - 36" Wide

Model	Description	Drawer Arrangement				File Capability
SS1836MLF	Modular Lateral File Pedestal	Lat File/Lat File				
SS1836MLFER	Modular Lateral File Pedestal	Lat File/Lat File				
SS1836MLFEL	Modular Lateral File Pedestal	Lat File/Lat File				
		Drawer Dimensions	Inside Depth	Inside Width	Inside Height	File Capability
	Lat File		12	32 ⁵ / ₁₆	9 ¹ / ₈	Double Legal or Letter Filing Front to Back; Letter Filing Side to Side

Interior Drawer Dimensions

18" Deep Modular Lateral File Pedestals - 30" Wide

<u>Model</u>	<u>Description</u>	<u>Drawer Arrangement</u>			
SS1830MLF	Modular Lateral File Pedestal	Lat File/Lat File			
<u>Drawer Dimensions</u>		<u>Inside Depth</u>	<u>Inside Width</u>	<u>Inside Height</u>	<u>File Capability</u>
Lat File		12	26 ⁵ / ₁₆	9 ¹ / ₈	Double Letter Filing Front to Back; Letter Filing Side to Side

24" Deep Modular Multi-File Pedestal - 36" Wide

<u>Model</u>	<u>Description</u>	<u>Drawer Arrangement</u>			
SS2436MMFR	Modular Multi-File Pedestal	Box/Box	File	Lat File	
SS2436MMFL	Modular Multi-File Pedestal	File	Box/Box	Lat File	
SS2436MMFER	Extended Modular Multi-File Pedestal	Box/Box	File	Lat File	
SS2436MMFEL	Extended Modular Multi-File Pedestal	File	Box/Box	Lat File	
<u>Drawer Dimensions</u>		<u>Inside Depth</u>	<u>Inside Width</u>	<u>Inside Height</u>	<u>File Capability</u>
Box 1		15	14 ⁵ / ₁₆	2 ¹ / ₄	N/A
Box 2		15	14 ⁵ / ₁₆	3 ¹ / ₄	N/A
File		15	14 ⁵ / ₁₆	9 ¹ / ₈	Letter Filing Front to Back; Legal or Letter Filing Side to Side
Lat File		15	32 ⁵ / ₁₆	9 ¹ / ₈	Double Legal or Letter Filing Front to Back; Legal Filing Side to Side

18" Deep Modular Multi-File Pedestal - 36" Wide

<u>Model</u>	<u>Description</u>	<u>Drawer Arrangement</u>			
SS1836MMFR	Modular Multi-File Pedestal	Box/Box	File	Lat File	
SS1836MMFL	Modular Multi-File Pedestal	File	Box/Box	Lat File	
SS1836MLFER	Extended Modular Multi-File Pedestal	Box/Box	File	Lat File	
SS1836MLFEL	Extended Modular Multi-File Pedestal	File	Box/Box	Lat File	
<u>Drawer Dimensions</u>		<u>Inside Depth</u>	<u>Inside Width</u>	<u>Inside Height</u>	<u>File Capability</u>
Box 1		12	14 ⁵ / ₁₆	2 ¹ / ₄	N/A
Box 2		12	14 ⁵ / ₁₆	3 ¹ / ₄	N/A
File		12	14 ⁵ / ₁₆	9 ¹ / ₈	Letter Filing Front to Back; Letter Filing Side to Side
Lat File		12	32 ⁵ / ₁₆	9 ¹ / ₈	Double Legal or Letter Filing Front to Back; Letter Filing Side to Side

Mobile Pedestal

<u>Model</u>	<u>Description</u>	<u>Drawer Arrangement</u>			
SS2018MP	Mobile Pedestal	Box/Box/File			
<u>Drawer Dimensions</u>		<u>Inside Depth</u>	<u>Inside Width</u>	<u>Inside Height</u>	<u>File Capability</u>
Box		15	14 ⁵ / ₁₆	2 ¹ / ₄	N/A
File		15	14 ⁵ / ₁₆	9 ¹ / ₈	Letter Filing Front to Back; Letter Filing Side to Side

24" Deep Tall Storage B/B/F Cabinets - 36" Wide

<u>Model</u>	<u>Description</u>	<u>Drawer Arrangement</u>			
SS2436-60BBFT	Storage Cabinet	Box/Box/Lat File			
SS2436-54BBFT	Storage Cabinet	Box/Box/Lat File			
SS2436-45BBFT	Storage Cabinet	Box/Box/Lat File			
<u>Drawer Dimensions</u>		<u>Inside Depth</u>	<u>Inside Width</u>	<u>Inside Height</u>	<u>File Capability</u>
Box 1		15	32 ⁵ / ₁₆	2 ¹ / ₄	N/A
Box 2		15	32 ⁵ / ₁₆	3 ¹ / ₄	N/A
Lat File		15	32 ⁵ / ₁₆	9 ¹ / ₈	Double Legal or Letter Filing Front to Back; Legal Filing Side to Side

24" Deep Tall Storage B/B/F Cabinets - 30" Wide

<u>Model</u>	<u>Description</u>	<u>Drawer Arrangement</u>			
SS2430-60BBFT	Storage Cabinet	Box/Box/Lat File			
SS2430-54BBFT	Storage Cabinet	Box/Box/Lat File			
SS2430-45BBFT	Storage Cabinet	Box/Box/Lat File			
<u>Drawer Dimensions</u>		<u>Inside Depth</u>	<u>Inside Width</u>	<u>Inside Height</u>	<u>File Capability</u>
Box 1		15	26 ⁵ / ₁₆	2 ¹ / ₄	N/A
Box 2		15	26 ⁵ / ₁₆	3 ¹ / ₄	N/A
Lat File		15	26 ⁵ / ₁₆	9 ¹ / ₈	Double Letter Filing Front to Back; Legal Filing Side to Side

SWISH

Interior Drawer Dimensions

18" Deep Tall Storage B/B/F Cabinets - 36" Wide

Model	Description	Drawer Arrangement			
SS1836-60BBFT	Storage Cabinet	Box/Box/Lat File			
SS1836-54BBFT	Storage Cabinet	Box/Box/Lat File			
SS1836-45BBFT	Storage Cabinet	Box/Box/Lat File			
Drawer Dimensions		Inside Depth	Inside Width	Inside Height	File Capability
Box 1		12 ¹ / ₁₆	32 ⁵ / ₁₆	2 ³ / ₄	N/A
Box 2		12 ¹ / ₁₆	32 ⁵ / ₁₆	3 ¹ / ₄	N/A
Lat File		12 ¹ / ₁₆	32 ⁵ / ₁₆	9 ¹ / ₈	Double Legal or Letter Filing Front to Back; Letter Filing Side to Side

18" Deep Tall Storage B/B/F Cabinets - 30" Wide

Model	Description	Drawer Arrangement			
SS1830-60BBFT	Storage Cabinet	Box/Box/Lat File			
SS1830-54BBFT	Storage Cabinet	Box/Box/Lat File			
SS1830-45BBFT	Storage Cabinet	Box/Box/Lat File			
Drawer Dimensions		Inside Depth	Inside Width	Inside Height	File Capability
Box 1		12	26 ⁵ / ₁₆	2 ³ / ₄	N/A
Box 2		12	26 ⁵ / ₁₆	3 ¹ / ₄	N/A
Lat File		12	26 ⁵ / ₁₆	9 ¹ / ₈	Double Letter Filing Front to Back; Letter Filing Side to Side

24" Deep Tall Storage F/F Cabinets - 36" Wide

Model	Description	Drawer Arrangement			
SS2436-60FFT	Storage Cabinet	Lat File/Lat File			
SS2436-54FFT	Storage Cabinet	Lat File/Lat File			
SS2436-45FFT	Storage Cabinet	Lat File/Lat File			
Drawer Dimensions		Inside Depth	Inside Width	Inside Height	File Capability
Lat File		15	32 ⁵ / ₁₆	9 ¹ / ₈	Double Legal or Letter Filing Front to Back; Legal Filing Side to Side

24" Deep Tall Storage F/F Cabinets - 30" Wide

Model	Description	Drawer Arrangement			
SS2430-60FFT	Storage Cabinet	Lat File/Lat File			
SS2430-54FFT	Storage Cabinet	Lat File/Lat File			
SS2430-45FFT	Storage Cabinet	Lat File/Lat File			
Drawer Dimensions		Inside Depth	Inside Width	Inside Height	File Capability
Lat File		15	26 ⁵ / ₁₆	9 ¹ / ₈	Double Letter Filing Front to Back; Legal Filing Side to Side

24" Deep Tall Storage Cabinets w/Side Access

Model	Description	Drawer Arrangement			
SS2418-60BBFSSTR	Storage Cabinet with Side Access	Box/Box/File			
SS2418-60BBFSSTL	Storage Cabinet with Side Access	Box/Box/File			
SS2418-54BBFSSTR	Storage Cabinet with Side Access	Box/Box/File			
SS2418-54BBFSSTL	Storage Cabinet with Side Access	Box/Box/File			
SS2418-45BBFSSTR	Storage Cabinet with Side Access	Box/Box/File			
SS2418-45BBFSSTL	Storage Cabinet with Side Access	Box/Box/File			
Drawer Dimensions		Inside Depth	Inside Width	Inside Height	File Capability
Box 1		15	14 ⁵ / ₁₆	2 ³ / ₄	N/A
Box 2		15	14 ⁵ / ₁₆	3 ¹ / ₄	N/A
File		15	14 ⁵ / ₁₆	9 ¹ / ₈	Letter Filing Front to Back; Legal or Letter Filing Side to Side

18" Deep Tall Storage Cabinets w/Side Access

Model	Description	Drawer Arrangement			
SS1818-60BBFSSTR	Storage Cabinet with Side Access	Box/Box/File			
SS1818-60BBFSSTL	Storage Cabinet with Side Access	Box/Box/File			
SS1818-54BBFSSTR	Storage Cabinet with Side Access	Box/Box/File			
SS1818-54BBFSSTL	Storage Cabinet with Side Access	Box/Box/File			
SS1818-45BBFSSTR	Storage Cabinet with Side Access	Box/Box/File			
SS1818-45BBFSSTL	Storage Cabinet with Side Access	Box/Box/File			
Drawer Dimensions		Inside Depth	Inside Width	Inside Height	File Capability
Box 1		12	14 ⁵ / ₁₆	2 ³ / ₄	N/A
Box 2		12	14 ⁵ / ₁₆	3 ¹ / ₄	N/A
File		12	14 ⁵ / ₁₆	9 ¹ / ₈	Letter Filing Front to Back; Letter Filing Side to Side

Interior Drawer Dimensions

24" Deep Tall Storage Wardrobe Cabinets

Model	Description	Drawer Arrangement		Inside Depth	Inside Width	Inside Height	File Capability
		User Left	User Right				
SS2430-60BBFWR	Storage Wardrobe	Box/Box/File	Wardrobe	15	14 ⁵ / ₁₆	2 ¹ / ₄	N/A
SS2430-60BBFWL	Storage Wardrobe	Wardrobe	Box/Box/File		14 ⁵ / ₁₆	3 ¹ / ₄	N/A
SS2430-54BBFWR	Storage Wardrobe	Box/Box/File	Wardrobe		14 ⁵ / ₁₆	9 ¹ / ₈	Letter Filing Front to Back; Legal or Letter Filing Side to Side
SS2430-54BBFWL	Storage Wardrobe	Wardrobe	Box/Box/File	15	14 ⁵ / ₁₆	2 ¹ / ₄	N/A
SS2430-45BBFWR	Storage Wardrobe	Box/Box/File	Wardrobe		14 ⁵ / ₁₆	3 ¹ / ₄	N/A
SS2430-45BBFWL	Storage Wardrobe	Wardrobe	Box/Box/File		14 ⁵ / ₁₆	9 ¹ / ₈	Letter Filing Front to Back; Legal or Letter Filing Side to Side
SS2430-60FFWR	Storage Wardrobe	File/File	Wardrobe	15	14 ⁵ / ₁₆	2 ¹ / ₄	N/A
SS2430-60FFWL	Storage Wardrobe	Wardrobe	File/File		14 ⁵ / ₁₆	3 ¹ / ₄	N/A
SS2430-54FFWR	Storage Wardrobe	File/File	Wardrobe		14 ⁵ / ₁₆	9 ¹ / ₈	Letter Filing Front to Back; Legal or Letter Filing Side to Side
SS2430-54FFWL	Storage Wardrobe	Wardrobe	File/File	15	14 ⁵ / ₁₆	2 ¹ / ₄	N/A
SS2430-45FFWR	Storage Wardrobe	File/File	Wardrobe		14 ⁵ / ₁₆	3 ¹ / ₄	N/A
SS2430-45FFWL	Storage Wardrobe	Wardrobe	File/File		14 ⁵ / ₁₆	9 ¹ / ₈	Letter Filing Front to Back; Legal or Letter Filing Side to Side

18" Deep Tall Storage Wardrobe Cabinets

Model	Description	Drawer Arrangement		Inside Depth	Inside Width	Inside Height	File Capability
		User Left	User Right				
SS1830-60BBFWR	Storage Wardrobe	Box/Box/File	Wardrobe	12	14 ⁵ / ₁₆	2 ¹ / ₄	N/A
SS1830-60BBFWL	Storage Wardrobe	Wardrobe	Box/Box/File		14 ⁵ / ₁₆	3 ¹ / ₄	N/A
SS1830-54BBFWR	Storage Wardrobe	Box/Box/File	Wardrobe		14 ⁵ / ₁₆	9 ¹ / ₈	Letter Filing Front to Back; Legal or Letter Filing Side to Side
SS1830-54BBFWL	Storage Wardrobe	Wardrobe	Box/Box/File	12	14 ⁵ / ₁₆	2 ¹ / ₄	N/A
SS1830-45BBFWR	Storage Wardrobe	Box/Box/File	Wardrobe		14 ⁵ / ₁₆	3 ¹ / ₄	N/A
SS1830-45BBFWL	Storage Wardrobe	Wardrobe	Box/Box/File		14 ⁵ / ₁₆	9 ¹ / ₈	Letter Filing Front to Back; Legal or Letter Filing Side to Side
SS1830-60FFWR	Storage Wardrobe	File/File	Wardrobe	12	14 ⁵ / ₁₆	2 ¹ / ₄	N/A
SS1830-60FFWL	Storage Wardrobe	Wardrobe	File/File		14 ⁵ / ₁₆	3 ¹ / ₄	N/A
SS1830-54FFWR	Storage Wardrobe	File/File	Wardrobe		14 ⁵ / ₁₆	9 ¹ / ₈	Letter Filing Front to Back; Legal or Letter Filing Side to Side
SS1830-54FFWL	Storage Wardrobe	Wardrobe	File/File	12	14 ⁵ / ₁₆	2 ¹ / ₄	N/A
SS1830-45FFWR	Storage Wardrobe	File/File	Wardrobe		14 ⁵ / ₁₆	3 ¹ / ₄	N/A
SS1830-45FFWL	Storage Wardrobe	Wardrobe	File/File		14 ⁵ / ₁₆	9 ¹ / ₈	Letter Filing Front to Back; Legal or Letter Filing Side to Side

24" Deep Bench Height Box/File - 36" Wide

Model	Description	Drawer Arrangement		Inside Depth	Inside Width	Inside Height	File Capability
		Box/File	Box/File				
SSB2436MBF	Modular Low Storage Box/File	Box/File	Box/File	15	32 ⁵ / ₁₆	2 ¹ / ₄	N/A
		Box	Box		32 ⁵ / ₁₆	9 ¹ / ₈	Double Letter or Legal Filing Front to Back; Legal Filing Side to Side
		Lat File	Lat File		32 ⁵ / ₁₆	9 ¹ / ₈	Double Letter or Legal Filing Front to Back; Legal Filing Side to Side

18" Deep Bench Height Box/File - 36" Wide

Model	Description	Drawer Arrangement		Inside Depth	Inside Width	Inside Height	File Capability
		Box/File	Box/File				
SSB1836MBF	Modular Low Storage Box/File	Box/File	Box/File	12	32 ⁵ / ₁₆	2 ¹ / ₄	N/A
		Box	Box		32 ⁵ / ₁₆	9 ¹ / ₈	Double Letter or Legal Filing Front to Back; Letter Filing Side to Side
		Lat File	Lat File		32 ⁵ / ₁₆	9 ¹ / ₈	Double Letter or Legal Filing Front to Back; Letter Filing Side to Side

24" Deep Bench Height Box/File - 30" Wide

Model	Description	Drawer Arrangement		Inside Depth	Inside Width	Inside Height	File Capability
		Box/File	Box/File				
SSB2430MBF	Modular Low Storage Box/File	Box/File	Box/File	15	26 ⁵ / ₁₆	2 ¹ / ₄	N/A
		Box	Box		26 ⁵ / ₁₆	9 ¹ / ₈	Double Letter Filing Front to Back; Legal Filing Side to Side
		Lat File	Lat File		26 ⁵ / ₁₆	9 ¹ / ₈	Double Letter Filing Front to Back; Legal Filing Side to Side

SWISH

Interior Drawer Dimensions

18" Deep Bench Height Box/File - 30" Wide

<u>Model</u>	<u>Description</u>	<u>Drawer Arrangement</u>				<u>File Capability</u>
SSB1830MBF	Modular Low Storage Box/File	Box/File				
	<u>Drawer Dimensions</u>	<u>Inside Depth</u>	<u>Inside Width</u>	<u>Inside Height</u>		
	Box	12	26 ⁵ / ₁₆	2 ¹ / ₄		N/A
	Lat File	12	26 ⁵ / ₁₆	9 ¹ / ₈		Double Letter Filing Front to Back; Letter Filing Side to Side

24" Deep Bench Height Box/File - 18" Wide

<u>Model</u>	<u>Description</u>	<u>Drawer Arrangement</u>				<u>File Capability</u>
SSB2418MBF	Modular Low Storage Box/File	Box/File				
	<u>Drawer Dimensions</u>	<u>Inside Depth</u>	<u>Inside Width</u>	<u>Inside Height</u>		
	Box	15	14 ⁵ / ₁₆	2 ¹ / ₄		N/A
	File	15	14 ⁵ / ₁₆	9 ¹ / ₈		Letter or Legal Filing Front to Back; Legal Filing Side to Side

18" Deep Bench Height Box/File - 18" Wide

<u>Model</u>	<u>Description</u>	<u>Drawer Arrangement</u>				<u>File Capability</u>
SSB1818MBF	Modular Low Storage Box/File	Box/File				
	<u>Drawer Dimensions</u>	<u>Inside Depth</u>	<u>Inside Width</u>	<u>Inside Height</u>		
	Box	12	14 ⁵ / ₁₆	2 ¹ / ₄		N/A
	Lat File	12	14 ⁵ / ₁₆	9 ¹ / ₈		Letter Filing Front to Back; Letter Filing Side to Side

Pre-Configured Order Check List:

Specify:

- 1. Model number
- 2. Laminate color
 - A. Worksurface color
 - B. Chassis color
- 3. Product options
 - A. EC10/EC11 cutout
 - B. Undersurface electrical

Example:

SS3672ED (model #)	BZW (worksurface color)	TP (chassis color)	EG001 (ECA cutout location)
------------------------------	----------------------------	-----------------------	--------------------------------

1. Model number

2. Laminate Color Options:

ALB Alabaster	GRH Graphite
AUT Autumn	HGL High Line
BLO Blonde Echo	SHD Shadow
BBN Bourbon	SHE Shea
BZW Brazilwood	SLG Slate Grey
BBL Bridal Blanco	STU Studio Teak
BRG Brighton	TAU Taupe
DWH Designer White	VIN Vintage
DOV Dove Grey	WLH Walnut Heights

3. Product Options:

- EC10 or EC11 Cutout:
 - Specify
 - EG100 (user left)
 - EG001 (user right)
 - EG101 (user left and right)

Two EC units in a worksurface less than 48" in width is not recommended. No upcharge for cutout.

NOTE: Cutouts for 18" deep worksurfaces will run perpendicular to user.

NOTE: EC10 and EC11 units must be ordered separately. Refer to page 214 for more information.
- Undersurface Electrical:
 - Specify the appropriate number below for the circuit number(s) desired.
 - P1 (circuit 1)
 - P2 (circuit 2)
 - PM (mix circuit 1 and circuit 2)

NOTE: Two circuit system requires a hardwire infeed.

When Undersurface Electrical is specified one duplex unit, two jumpers and two H block connectors will be mounted to the underside of units less than 60" in width. Units 60" in width and wider will have two duplex units, two jumpers and two H block connectors.

NOTE: Infeed cables and additional jumper cables must be ordered separately. Refer to pages 215-217 for additional information.

Edge Profile:



Eased (R6)

Pull Style and Color:



Flat (Alloy finish)

NOTE: All drawers are predrilled for easy field installation. Pulls for drawers can be installed in the left, center or right locations. All hinged doors below the worksurface are predrilled as well.

Counterweights:

In order to pass stability tests some Pre-Configured units will require a counterweight to be mounted on the inside of the back panel of the unit. The 1/2" thick counterweight is available in 10 lb. and 20 lb. weights and is field installed. The counterweight will need to be ordered separately, see page 75. Some units may require 40 lbs. of counterweight; in that case two 20 lb. counterweights will need to be ordered. As an alternative to the counterweight the unit can be secured to the wall or floor.

PRE-CONFIGURED

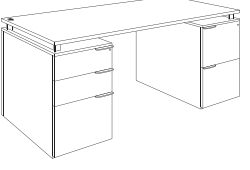
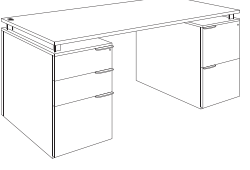
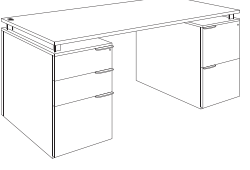
Description	① Model	D	W	H	CTN WT	CU FT	List Price
Executive Height Double Pedestal Desk With Overhang 	SS3672ED · 6" overhang on approach side · chassis - 30" x 72" · two grommets - left and right on approach side · vertical wire access through pedestals · 2 1/4" tall acrylic plenum on ends and approach side · 2" black wire management trough · 18" wide front locking pedestals · box/box/file pedestal · file/file pedestal · kneespace - 36" · field installed pulls · optional cutout for EC10 and EC11, see page 214 · optional undersurface electrical includes two duplex units · ships modular	36	72	29 3/8	329	34	\$2,767
		Undersurface Electrical Included List Price					
Executive Height Double Pedestal Desk 	SS3666ED · 6" overhang on approach side · chassis - 30" x 66" · two grommets - left and right on approach side · vertical wire access through pedestals · 2 1/4" tall acrylic plenum on ends and approach side · 2" black wire management trough · 18" wide front locking pedestals · box/box/file pedestal · file/file pedestal · kneespace - 30" · field installed pulls · optional cutout for EC10 and EC11, see page 214 · optional undersurface electrical includes two duplex units · ships modular	36	66	29 3/8	322	33	\$2,718
		Undersurface Electrical Included List Price					
Executive Height Double Pedestal Desk 	SS3072DD · two grommets - left and right on approach side · vertical wire access through pedestals · 2 1/4" tall acrylic plenum on ends and approach side · 2" black wire management trough · 18" wide front locking pedestals · box/box/file pedestal · file/file pedestal · kneespace - 36" · field installed pulls · optional cutout for EC10 and EC11, see page 214 · optional undersurface electrical includes two duplex units · ships modular	30	72	29 3/8	315	33	\$2,694
		Undersurface Electrical Included List Price					
Executive Height Double Pedestal Desk 	SS3066DD · two grommets - left and right on approach side · vertical wire access through pedestals · 2 1/4" tall acrylic plenum on ends and approach side · 2" black wire management trough · 18" wide front locking pedestals · box/box/file pedestal · file/file pedestal · kneespace - 30" · field installed pulls · optional cutout for EC10 and EC11, see page 214 · optional undersurface electrical includes two duplex units · ships modular	30	66	29 3/8	309	32	\$2,650
		Undersurface Electrical Included List Price					

SWISH

PRE-CONFIGURED

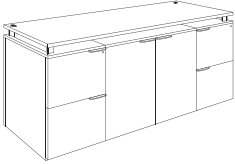
Description	1 Model	D	W	H	CTN WT	CU FT	List Price
Executive Height Storage Credenza 	SS2472SCHD · two grommets - left and right corners · vertical wire access through pedestals · 2 1/4" tall acrylic plenum on ends and approach side · 2" black wire management trough · 18" wide front locking pedestals · file/file pedestals · hinged center doors · adjustable shelf in storage cabinet · non-locking doors standard; locking doors available, specify and add \$105 list · field installed pulls · optional cutout for EC10 and EC11, see page 214 · ships modular	24	72	29 3/8	454	44	\$3,454
	SS2466SCHD · two grommets - left and right corners · vertical wire access through pedestals · 2 1/4" tall acrylic plenum on ends and approach side · 2" black wire management trough · 18" wide front locking pedestals · file/file pedestals · hinged center doors · adjustable shelf in storage cabinet · non-locking doors standard; locking doors available, specify and add \$105 list · field installed pulls · optional cutout for EC10 and EC11, see page 214 · ships modular	24	66	29 3/8	407	41	\$3,314
	SS1872SCHD · two grommets - left and right corners · vertical wire access through pedestals · 2 1/4" tall acrylic plenum on ends and approach side · 2" black wire management trough · 18" wide front locking pedestals · file/file pedestals · hinged center doors · adjustable shelf in storage cabinet · non-locking doors standard; locking doors available, specify and add \$105 list · field installed pulls · optional cutout for EC10 and EC11, see page 214; due to depth of top, cutout will run perpendicular to user · ships modular	18	72	29 3/8	361	35	\$3,215

SWISH

To Order, Specify:

- 1 Model number
- 2 Laminate color
 - A. Worksurface color
 - B. Chassis color
- 3 Product Options (see page 63)

2 Laminate Color Options:

ALB	Alabaster	GRH	Graphite
AUT	Autumn	HGL	High Line
BLO	Blonde Echo	SHD	Shadow
BBN	Bourbon	SHE	Shea
BZW	Brazilwood	SLG	Slate Grey
BBL	Bridal Blanco	STU	Studio Teak
BRG	Brighton	TAU	Taupe
DWH	Designer White	VIN	Vintage
DOV	Dove Grey	WLH	Walnut Heights

Order Check List
page 63

Product Specifications
page 40

Power and Data Options
page 214

Undersurface Electrical Options
pages 215-217

PRE-CONFIGURED

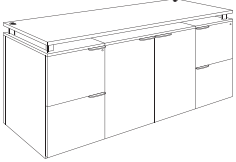
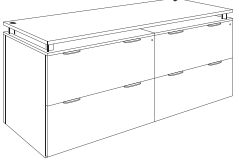
Description	① Model	D	W	H	CTN WT	CU FT	List Price
<p>Executive Height Storage Credenza</p> 	<p>SS1866SCHD</p> <ul style="list-style-type: none"> · two grommets - left and right corners · vertical wire access through pedestals · 2 1/4" tall acrylic plenum on ends and approach side · 2" black wire management trough · 18" wide front locking pedestals · file/file pedestals · hinged center doors · adjustable shelf in storage cabinet · non-locking doors standard; locking doors available, specify and add \$105 list · field installed pulls · optional cutout for EC10 and EC11, see page 214; due to depth of top, cutout will run perpendicular to user · ships modular 	18	66	29 3/8	343	32	\$3,087
<p>Executive Height Double Lateral File Credenza</p> 	<p>SS2472LFC</p> <ul style="list-style-type: none"> · two grommets - left and right corners · vertical wire access through pedestals · 2 1/4" tall acrylic plenum on ends and approach side · 2" black wire management trough · two drawer lateral files side by side · pedestal front locking · field installed pulls · two 20 lb. counterweights required, one for each side of unit, see page 75 for counterweight · unit can be secured to wall or floor as alternative to counterweight · optional cutout for EC10 and EC11, see page 214 · ships modular 	24	72	29 3/8	410	43	\$3,334
	<p>SS2460LFC</p> <ul style="list-style-type: none"> · two grommets - left and right corners · vertical wire access through pedestals · 2 1/4" tall acrylic plenum on ends and approach side · 2" black wire management trough · two drawer lateral files side by side · pedestal front locking · field installed pulls · two 20 lb. counterweights required, one for each side of unit, see page 75 for counterweight · unit can be secured to wall or floor as alternative to counterweight · optional cutout for EC10 and EC11, see page 214 · ships modular 	24	60	29 3/8	360	36	\$3,011

SWISH

PRE-CONFIGURED

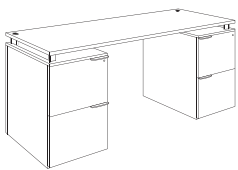
Description	1 Model	D	W	H	CTN WT	CU FT	List Price
Executive Height Kneespace Credenza 	SS2472KC • two grommets - left and right corners • vertical wire access through pedestals • 2 1/4" tall acrylic plenum on ends and approach side • 2" black wire management trough • 18" wide front locking pedestals • file/file pedestals • kneespace - 36" • field installed pulls • optional cutout for EC10 and EC11, see page 214 • optional undersurface electrical includes two duplex units • ships modular	24	72	29 3/8	276	27	\$2,441
		Undersurface Electrical Included List Price					
	SS2466KC • two grommets - left and right corners • vertical wire access through pedestals • 2 1/4" tall acrylic plenum on ends and approach side • 2" black wire management trough • 18" wide front locking pedestals • file/file pedestals • kneespace - 30" • field installed pulls • optional cutout for EC10 and EC11, see page 214 • optional undersurface electrical includes two duplex units • ships modular	24	66	29 3/8	271	27	\$2,402
Undersurface Electrical Included List Price						\$2,784	
	SS1872KC • two grommets - left and right corners • vertical wire access through pedestals • 2 1/4" tall acrylic plenum on ends and approach side • 2" black wire management trough • 18" wide front locking pedestals • file/file pedestals • kneespace - 36" • field installed pulls • optional cutout for EC10 and EC11, see page 214; due to depth of top, cutout will run perpendicular to user • optional undersurface electrical includes two duplex units • ships modular	18	72	29 3/8	236	22	\$2,278
Undersurface Electrical Included List Price						\$2,624	
	SS1866KC • two grommets - left and right corners • vertical wire access through pedestals • 2 1/4" tall acrylic plenum on ends and approach side • 2" black wire management trough • 18" wide front locking pedestals • file/file pedestals • kneespace - 30" • field installed pulls • optional cutout for EC10 and EC11, see page 214; due to depth of top, cutout will run perpendicular to user • optional undersurface electrical includes two duplex units • ships modular	18	66	29 3/8	233	21	\$2,243
Undersurface Electrical Included List Price						\$2,586	

SWISH

To Order, Specify:

- 1 Model number
- 2 Laminate color
 - A. Worksurface color
 - B. Chassis color
- 3 Product Options (see page 63)

2 Laminate Color Options:

ALB	Alabaster	GRH	Graphite
AUT	Autumn	HGL	High Line
BLO	Blonde Echo	SHD	Shadow
BBN	Bourbon	SHE	Shea
BZW	Brazilwood	SLG	Slate Grey
BBL	Bridal Blanco	STU	Studio Teak
BRG	Brighton	TAU	Taupe
DWH	Designer White	VIN	Vintage
DOV	Dove Grey	WLH	Walnut Heights

Order Check List

page 63

Product Specifications

page 40

Power and Data Options

page 214

Undersurface Electrical Options

pages 215-217

PRE-CONFIGURED

Description	① Model	D	W	H	CTN WT	CU FT	List Price
	SS2436BBF · two grommets - left and right corners · vertical wire access through pedestal · 2 ¼" tall acrylic plenum on ends and approach side · pedestal front locking · box/box/lateral file pedestal · field installed pulls · ships assembled	24	36	29 ¾	207	23	\$1,851
	SS1836BBF · two grommets - left and right corners · vertical wire access through pedestal · 2 ¼" tall acrylic plenum on ends and approach side · pedestal front locking · box/box/lateral file pedestal · field installed pulls · two 20 lb. counterweights required, see page 75 for counterweight · unit can be secured to wall or floor as alternative to counterweight · ships assembled	18	36	29 ¾	170	18	\$1,715
	SS2430BBF · two grommets - left and right corners · vertical wire access through pedestal · 2 ¼" tall acrylic plenum on ends and approach side · pedestal front locking · box/box/lateral file pedestal · field installed pulls · ships assembled	24	30	29 ¾	182	19	\$1,690
	SS1830BBF · two grommets - left and right corners · vertical wire access through pedestal · 2 ¼" tall acrylic plenum on ends and approach side · pedestal front locking · box/box/lateral file pedestal · field installed pulls · two 20 lb. counterweights required, see page 75 for counterweight · unit can be secured to wall or floor as alternative to counterweight · ships assembled	18	30	29 ¾	151	16	\$1,584

Description	① Model	Fabric Grade/List Price												
		COM	A	B	C	D	E	F	G	H	I	J	L1	L2
	SS2018MP · box/file only · upholstered cushion top · locking casters · pedestal front locking · ships assembled	\$1,129	\$1,140	\$1,159	\$1,193	\$1,237	\$1,281	\$1,350	\$1,423	\$1,501	\$1,624	\$1,770	\$1,477	\$1,565
	D 20 W 18 H 24 ½ CTN WT 85 COM YDG 1 CU FT 6													

PRE-CONFIGURED

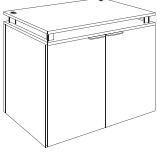
Description	① Model	D	W	H	CTN WT	CU FT	List Price
Executive Height Lateral File 	SS2436LF · two grommets - left and right corners · vertical wire access through pedestal · 2 1/4" tall acrylic plenum on ends and approach side · two drawers · anti-tip interlock mechanism · pedestal front locking · field installed pulls · one 20 lb. counterweight required, see page 75 for counterweight · unit can be secured to wall or floor as alternative to counterweight · ships assembled	24	36	29 3/8	206	23	\$1,816
	SS2430LF · two grommets - left and right corners · vertical wire access through pedestal · 2 1/4" tall acrylic plenum on ends and approach side · two drawers · anti-tip interlock mechanism · pedestal front locking · field installed pulls · one 20 lb. counterweight required, see page 75 for counterweight · unit can be secured to wall or floor as alternative to counterweight · ships assembled	24	30	29 3/8	181	19	\$1,664
Executive Height Hinged Door Pedestal 	SS2436HD · two grommets - left and right corners · vertical wire access through pedestal · 2 1/4" tall acrylic plenum on ends and approach side · one adjustable shelf · pedestal front locking · field installed pulls · ships assembled	24	36	29 3/8	181	23	\$1,563
	SS1836HD · two grommets - left and right corners · vertical wire access through pedestal · 2 1/4" tall acrylic plenum on ends and approach side · one adjustable shelf · pedestal front locking · field installed pulls · ships assembled	18	36	29 3/8	151	18	\$1,444
	SS2430HD · two grommets - left and right corners · vertical wire access through pedestal · 2 1/4" tall acrylic plenum on ends and approach side · one adjustable shelf · pedestal front locking · field installed pulls · ships assembled	24	30	29 3/8	159	19	\$1,434
	SS1830HD · two grommets - left and right corners · vertical wire access through pedestal · 2 1/4" tall acrylic plenum on ends and approach side · one adjustable shelf · pedestal front locking · field installed pulls · ships assembled	18	30	29 3/8	133	16	\$1,330

SWISH

To Order, Specify:

- ① Model number
- ② Laminate color
 - A. Worksurface color
 - B. Chassis color

② Laminate Color Options:

ALB Alabaster	GRH Graphite
AUT Autumn	HGL High Line
BLO Blonde Echo	SHD Shadow
BBN Bourbon	SHE Shea
BZW Brazilwood	SLG Slate Grey
BBL Bridal Bianco	STU Studio Teak
BRG Brighton	TAU Taupe
DWH Designer White	VIN Vintage
DOV Dove Grey	WLH Walnut Heights

Order Check List
page 63

Product Specifications
page 40

PRE-CONFIGURED

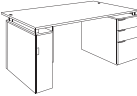
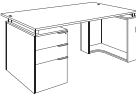
Description		① Model	D	W	H	CTN WT	CU FT	List Price
 Right	Executive Height Rectangle Single Pedestal Desk with Overhang · 6" overhang on approach side · chassis - 30" x 72" · two grommets - left and right corners · vertical wire access through pedestal · 2 1/4" tall acrylic plenum on ends and approach side · 2" black wire management trough · 18" wide front locking pedestals · box/box/file pedestal · 18" corner wing with grommet · kneespace - 45" · field installed pulls · optional cutout for EC10 and EC11, see page 214 · optional undersurface electrical includes two duplex units · ships modular	Right	36	72	29 3/8	289	34	\$2,555
	· 6" overhang on approach side · chassis - 30" x 72" · two grommets - left and right corners · vertical wire access through pedestal · 2 1/4" tall acrylic plenum on ends and approach side · 2" black wire management trough · 18" wide front locking pedestals · box/box/file pedestal · 18" corner wing with grommet · kneespace - 45" · field installed pulls · optional cutout for EC10 and EC11, see page 214 · optional undersurface electrical includes two duplex units · ships modular	Left	SS3672LED	36	72	29 3/8	289	34
		Undersurface Electrical Included List Price						\$2,904
 Left	Executive Height Rectangle Single Pedestal Desk with Overhang · 6" overhang on approach side · chassis - 24" x 72" · two grommets - left and right corners · vertical wire access through pedestal · 2 1/4" tall acrylic plenum on ends and approach side · 2" black wire management trough · 18" wide front locking pedestals · box/box/file pedestal · 18" corner wing with grommet · kneespace - 45" · field installed pulls · optional cutout for EC10 and EC11, see page 214 · optional undersurface electrical includes two duplex units · ships modular	Right	30	72	29 3/8	250	29	\$2,362
	· 6" overhang on approach side · chassis - 24" x 72" · two grommets - left and right corners · vertical wire access through pedestal · 2 1/4" tall acrylic plenum on ends and approach side · 2" black wire management trough · 18" wide front locking pedestals · box/box/file pedestal · 18" corner wing with grommet · kneespace - 45" · field installed pulls · optional cutout for EC10 and EC11, see page 214 · optional undersurface electrical includes two duplex units · ships modular	Left	SS3072LED	30	72	29 3/8	250	29
		Undersurface Electrical Included List Price						\$2,709
	Executive Height Rectangle Single Pedestal Desk with Overhang · 6" overhang on approach side · chassis - 30" x 66" · two grommets - left and right corners · vertical wire access through pedestal · 2 1/4" tall acrylic plenum on ends and approach side · 2" black wire management trough · 18" wide front locking pedestals · box/box/file pedestal · 18" corner wing with grommet · kneespace - 39" · field installed pulls · optional cutout for EC10 and EC11, see page 214 · optional undersurface electrical includes two duplex units · ships modular	Right	36	66	29 3/8	282	33	\$2,506
	· 6" overhang on approach side · chassis - 30" x 66" · two grommets - left and right corners · vertical wire access through pedestal · 2 1/4" tall acrylic plenum on ends and approach side · 2" black wire management trough · 18" wide front locking pedestals · box/box/file pedestal · 18" corner wing with grommet · kneespace - 39" · field installed pulls · optional cutout for EC10 and EC11, see page 214 · optional undersurface electrical includes two duplex units · ships modular	Left	SS3666LED	36	66	29 3/8	282	33
		Undersurface Electrical Included List Price						\$2,848
	Executive Height Rectangle Single Pedestal Desk with Overhang · 6" overhang on approach side · chassis - 24" x 66" · two grommets - left and right corners · vertical wire access through pedestal · 2 1/4" tall acrylic plenum on ends and approach side · 2" black wire management trough · 18" wide front locking pedestals · box/box/file pedestal · 18" corner wing with grommet · kneespace - 39" · field installed pulls · optional cutout for EC10 and EC11, see page 214 · optional undersurface electrical includes two duplex units · ships modular	Right	30	66	29 3/8	244	28	\$2,318
	· 6" overhang on approach side · chassis - 24" x 66" · two grommets - left and right corners · vertical wire access through pedestal · 2 1/4" tall acrylic plenum on ends and approach side · 2" black wire management trough · 18" wide front locking pedestals · box/box/file pedestal · 18" corner wing with grommet · kneespace - 39" · field installed pulls · optional cutout for EC10 and EC11, see page 214 · optional undersurface electrical includes two duplex units · ships modular	Left	SS3066LED	30	66	29 3/8	244	28
		Undersurface Electrical Included List Price						\$2,660

SWISH

PRE-CONFIGURED

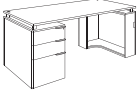
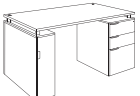
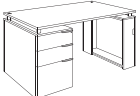
		Description	Model	D	W	H	CTN WT	CU FT	List Price	
 Right	 Left	Executive Height Rectangle Single Pedestal Desk • two grommets - left and right corners • vertical wire access through pedestal • 2 1/4" tall acrylic plenum on ends and approach side • 2" black wire management trough • 18" wide front locking pedestals • box/box/file pedestal • 18" corner wing with grommet • kneespace - 45" for 72" wide units • knee space - 39" for 66" wide units • field installed pulls • optional cutout for EC10 and EC11, see page 214 • optional undersurface electrical includes two duplex units • ships modular	Right	SS3072RD	30	72	29 3/8	275	33	\$2,482
			Left	SS3072LD	30	72	29 3/8	275	33	\$2,482
			Undersurface Electrical Included List Price							\$2,830
			Right	SS3066RD	30	66	29 3/8	269	32	\$2,438
			Left	SS3066LD	30	66	29 3/8	269	32	\$2,438
			Undersurface Electrical Included List Price							\$2,781
 Right	 Left	Executive Height Rectangle Single Pedestal Desk • two grommets - left and right corners • vertical wire access through pedestal • 2 1/4" tall acrylic plenum on ends and approach side • 2" black wire management trough • 18" wide front locking pedestals • box/box/file pedestal • 9" wing with grommet • kneespace 33" • field installed pulls • optional cutout for EC10 and EC11, see page 214 • optional undersurface electrical includes two duplex units • ships modular	Right	SS3060RD	30	60	29 3/8	239	26	\$2,285
			Left	SS3060LD	30	60	29 3/8	239	26	\$2,285
			Undersurface Electrical Included List Price							\$2,623

SWISH

To Order, Specify:

- 1 Model number
- 2 Laminate color
 - A. Worksurface color
 - B. Chassis color
- 3 Product Options (see page 63)

2 Laminate Color Options:

ALB	Alabaster	GRH	Graphite
AUT	Autumn	HGL	High Line
BLO	Blonde Echo	SHD	Shadow
BBN	Bourbon	SHE	Shea
BZW	Brazilwood	SLG	Slate Grey
BBL	Bridal Blanco	STU	Studio Teak
BRG	Brighton	TAU	Taupe
DWH	Designer White	VIN	Vintage
DOV	Dove Grey	WLH	Walnut Heights

Order Check List

page 63

Product Specifications

page 40





Power and Data Options

page 214

Undersurface Electrical Options

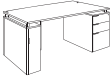
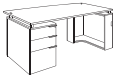
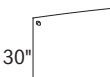
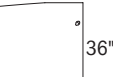
pages 215-217

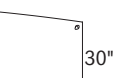
PRE-CONFIGURED

		Description	① Model	Left D	Right D	W	H	CTN WT	CU FT	List Price	
 Right	 Left	Executive Height Fin Single Pedestal Desk	Right	SS3672RFD	30	36	72	29 3/8	282	34	\$2,999
			Left	SS3672LFD	36	30	72	29 3/8	282	34	\$2,999
				Undersurface Electrical Included List Price							\$3,347
		<ul style="list-style-type: none"> · straight edge on user side · chassis - 30" x 72" · two grommets - left and right corners · vertical wire access through pedestal · 2 1/4" tall acrylic plenum on ends and approach side · 2" black wire management trough · 18" wide front locking pedestals · box/box/file pedestal · 18" corner wing with grommet · kneespace - 45" · field installed pulls · optional cutout for EC10 and EC11, see page 214 · optional undersurface electrical includes two duplex units · ships modular 									
 30"	 36"	Executive Height Fin Single Pedestal Desk	Right	SS3072RFD	24	30	72	29 3/8	243	29	\$2,785
			Left	SS3072LFD	30	24	72	29 3/8	243	29	\$2,785
				Undersurface Electrical Included List Price							\$3,133
		<ul style="list-style-type: none"> · straight edge on user side · chassis - 24" x 72" · two grommets - left and right corners · vertical wire access through pedestal · 2 1/4" tall acrylic plenum on ends and approach side · 2" black wire management trough · 18" wide front locking pedestals · box/box/file pedestal · 18" corner wing with grommet · kneespace - 45" · field installed pulls · optional cutout for EC10 and EC11, see page 214 · optional undersurface electrical includes two duplex units · ships modular 									
 36"	 30"	Executive Height Fin Single Pedestal Desk	Right	SS3666RFD	30	36	66	29 3/8	275	33	\$2,979
			Left	SS3666LFD	36	30	66	29 3/8	275	33	\$2,979
				Undersurface Electrical Included List Price							\$3,323
		<ul style="list-style-type: none"> · straight edge on user side · chassis - 30" x 66" · two grommets - left and right corners · vertical wire access through pedestal · 2 1/4" tall acrylic plenum on ends and approach side · 2" black wire management trough · 18" wide front locking pedestals · box/box/file pedestal · 18" corner wing with grommet · kneespace - 39" · field installed pulls · optional cutout for EC10 and EC11, see page 214 · optional undersurface electrical includes two duplex units · ships modular 									
 24"	 30"	Executive Height Fin Single Pedestal Desk	Right	SS3066RFD	24	30	66	29 3/8	238	28	\$2,763
			Left	SS3066LFD	30	24	66	29 3/8	238	28	\$2,763
				Undersurface Electrical Included List Price							\$3,106
		<ul style="list-style-type: none"> · straight edge on user side · chassis - 24" x 66" · two grommets - left and right corners · vertical wire access through pedestal · 2 1/4" tall acrylic plenum on ends and approach side · 2" black wire management trough · 18" wide front locking pedestals · box/box/file pedestal · 18" corner wing with grommet · kneespace - 39" · field installed pulls · optional cutout for EC10 and EC11, see page 214 · optional undersurface electrical includes two duplex units · ships modular 									

SWISH

PRE-CONFIGURED

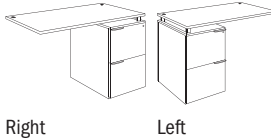
Description		① Model	D	W	H	CTN WT	CU FT	List Price	
 <p>Right Left</p>	Executive Height Single Pedestal Return	Right	24	48	29 3/8	149	15	\$1,434	
	<ul style="list-style-type: none"> two grommets - left and right corners vertical wire access through pedestal 2 1/4" tall acrylic plenum on end and approach side 	Left	24	48	29 3/8	149	15	\$1,434	
	Undersurface Electrical Included List Price								\$1,696
	<ul style="list-style-type: none"> 2" black wire management trough 	Right	24	42	29 3/8	143	14	\$1,361	
	<ul style="list-style-type: none"> 18" wide front locking pedestals file/file pedestal 	Left	24	42	29 3/8	143	14	\$1,361	
	Undersurface Electrical Included List Price								\$1,619
	<ul style="list-style-type: none"> perpendicular grain to user side field installed pulls 	Right	18	48	29 3/8	127	12	\$1,341	
	<ul style="list-style-type: none"> optional cutout for EC10 and EC11, see page 214; cutout for 18" deep models will run perpendicular to user 	Left	18	48	29 3/8	127	12	\$1,341	
	Undersurface Electrical Included List Price								\$1,603
	<ul style="list-style-type: none"> EC units available on pedestal side only for 18" deep models 	Right	18	42	29 3/8	122	12	\$1,273	
	<ul style="list-style-type: none"> optional undersurface electrical includes one duplex unit ships with one flat mounting bracket ships modular 	Left	18	42	29 3/8	122	12	\$1,273	
	Undersurface Electrical Included List Price								\$1,530

Description	① Model	D	W	H	CTN WT	CU FT	List Price	
	SST4824BRDGG	24	48	1 3/16	42	5	\$577	
	<ul style="list-style-type: none"> two grommets - left and right corners 2 1/4" tall acrylic plenum 2" black wire management trough perpendicular grain to user side optional cutout for EC10 and EC11, see page 214 optional undersurface electrical includes one duplex unit ships with mounting brackets 	Undersurface Electrical Included List Price						\$839
	SST4818BRDGG	18	48	1 3/16	33	4	\$515	
	<ul style="list-style-type: none"> two grommets - left and right corners 2 1/4" tall acrylic plenum 2" black wire management trough perpendicular grain to user side optional undersurface electrical includes one duplex unit ships with mounting brackets 	Undersurface Electrical Included List Price						\$776
	SST4224BRDGG	24	42	1 3/16	36	4	\$504	
	<ul style="list-style-type: none"> two grommets - left and right corners 2 1/4" tall acrylic plenum 2" black wire management trough perpendicular grain to user side optional cutout for EC10 and EC11, see page 214 optional undersurface electrical includes one duplex unit ships with mounting brackets 	Undersurface Electrical Included List Price						\$763
	SST4218BRDGG	18	42	1 3/16	28	4	\$447	
	<ul style="list-style-type: none"> two grommets - left and right corners 2 1/4" tall acrylic plenum 2" black wire management trough perpendicular grain to user side optional undersurface electrical includes one duplex unit ships with mounting brackets 	Undersurface Electrical Included List Price						\$704

To Order, Specify:

- ① Model number
- ② Laminate color
 - A. Worksurface color
 - B. Chassis color
- ③ Product Options (see page 63)

② Laminate Color Options:



ALB Alabaster	GRH Graphite
AUT Autumn	HGL High Line
BLO Blonde Echo	SHD Shadow
BBN Bourbon	SHE Shea
BZW Brazilwood	SLG Slate Grey
BBL Bridal Blanco	STU Studio Teak
BRG Brighton	TAU Taupe
DWH Designer White	VIN Vintage
DOV Dove Grey	WLH Walnut Heights

Order Check List

- page 63
- Product Specifications**
- page 40
- Power and Data Options**
- page 214
- Undersurface Electrical Options**
- pages 215-217

SWISH

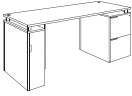
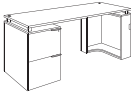
PRE-CONFIGURED

Description		① Model	D	W	H	CTN WT	CU FT	List Price		
 Right	 Left	Executive Height Single Pedestal Credenza	Right	SS2472RC	24	72	29 3/8	237	27	\$2,265
		Left	SS2472LC	24	72	29 3/8	237	27	\$2,265	
		Undersurface Electrical Included List Price \$2,614								
		Right	SS2466RC	24	66	29 3/8	232	27	\$2,226	
		Left	SS2466LC	24	66	29 3/8	232	27	\$2,226	
		Undersurface Electrical Included List Price \$2,571								
		Right	SS1872RC	18	72	29 3/8	204	22	\$2,108	
		Left	SS1872LC	18	72	29 3/8	204	22	\$2,108	
		Undersurface Electrical Included List Price \$2,456								
		Right	SS1866RC	18	66	29 3/8	201	21	\$2,073	
		Left	SS1866LC	18	66	29 3/8	201	21	\$2,073	
		Undersurface Electrical Included List Price \$2,418								
 Right	 Left	Executive Height Single Pedestal Credenza	Right	SS1860RC	18	60	29 3/8	197	21	\$1,965
		Left	SS1860LC	18	60	29 3/8	197	21	\$1,965	
		Undersurface Electrical Included List Price \$2,304								

SWISH

PRE-CONFIGURED

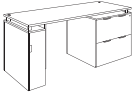
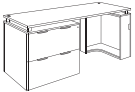
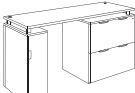
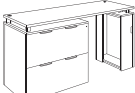
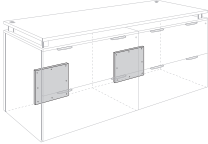
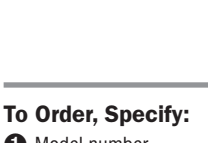
Description		① Model	D	W	H	CTN WT	CU FT	List Price		
 Right	 Left	Executive Height Single Lateral Pedestal Credenza								
		<ul style="list-style-type: none"> two grommets - left and right corners vertical wire access through pedestal 2 1/4" tall acrylic plenum on ends and approach side 2" black wire management trough pedestal front locking 36" width lateral file 18" corner wing with grommet kneespace - 27" for 72" wide units kneespace - 21" for 66" wide units field installed pulls optional cutout for EC10 and EC11, see page 214; cutout for 18" deep models will run perpendicular to user optional undersurface electrical includes two duplex units two 20 lb. counterweights required for 18" deep units, see below for counterweight unit can be secured to wall or floor as alternative to counterweight ships modular 	Right	SS2472LRC	24	72	29 3/8	304	35	\$2,714
			Left	SS2472LLC	24	72	29 3/8	304	35	\$2,714
						Undersurface Electrical Included List Price		\$3,060		
			Right	SS2466LRC	24	66	29 3/8	299	35	\$2,674
			Left	SS2466LLC	24	66	29 3/8	299	35	\$2,674
						Undersurface Electrical Included List Price		\$3,017		
			Right	SS1872LRC	18	72	29 3/8	254	28	\$2,510
			Left	SS1872LLC	18	72	29 3/8	254	28	\$2,510
						Undersurface Electrical Included List Price		\$2,858		
			Right	SS1866LRC	18	66	29 3/8	251	27	\$2,475
			Left	SS1866LLC	18	66	29 3/8	251	27	\$2,475
						Undersurface Electrical Included List Price		\$2,819		
 Right	 Left	Executive Height Single Lateral Pedestal Credenza								
		<ul style="list-style-type: none"> two grommets - left and right corners vertical wire access through pedestal 2 1/4" tall acrylic plenum on ends and approach side 2" black wire management trough pedestal front locking 30" width lateral file 9" wing with grommet kneespace 21" field installed pulls optional cutout for EC10 and EC11, see page 214; due to depth of top, cutout will run perpendicular to user optional undersurface electrical includes two duplex units two 20 lb. counterweights required, see below for counterweight unit can be secured to wall or floor as alternative to counterweight ships modular 	Right	SS1860LRC	18	60	29 3/8	229	24	\$2,287
			Left	SS1860LLC	18	60	29 3/8	229	24	\$2,287
						Undersurface Electrical Included List Price		\$2,625		
	20 lb. Counterweight	SS20LB	1/2	12	11 1/4	21	1	\$184		
	<ul style="list-style-type: none"> attaches to inside back panel of unit field installed hardware included 									
	10 lb. Counterweight	SS10LB	1/2	12	6	11	1	\$93		
	<ul style="list-style-type: none"> attaches to inside back panel of unit field installed hardware included 									

To Order, Specify:

- ① Model number
- ② Laminate color
 - A. Worksurface color
 - B. Chassis color
- ③ Product Options (see page 63)

② Laminate Color Options:

ALB Alabaster	GRH Graphite
AUT Autumn	HGL High Line
BLO Blonde Echo	SHD Shadow
BBN Bourbon	SHE Shea
BZW Brazilwood	SLG Slate Grey
BBL Bridal Blanco	STU Studio Teak
BRG Brighton	TAU Taupe
DWH Designer White	VIN Vintage
DOV Dove Grey	WLH Walnut Heights

Order Check List
page 63

Product Specifications
page 40

Power and Data Options
page 214

Undersurface Electrical Options
pages 215-217

Worksurface Order Check List:

Specify:

- 1. Model number
- 2. Worksurface laminate color
- 3. Product options
 - A. EC10/EC11 cutout
 - B. Undersurface electrical

Example:

SST2472UFING-BA | BBL | EG100
 (model #) | (worksurface color) | (EC cutout location)

1. Model number

2. Laminate Color Options:

ALB	Alabaster	GRH	Graphite
AUT	Autumn	HGL	High Line
BLO	Blonde Echo	SHD	Shadow
BBN	Bourbon	SHE	Shea
BZW	Brazilwood	SLG	Slate Grey
BBL	Bridal Blanco	STU	Studio Teak
BRG	Brighton	TAU	Taupe
DWH	Designer White	VIN	Vintage
DOV	Dove Grey	WLH	Walnut Heights

3. Product Options:

- EC10 or EC11 Cutout:

Specify

- EG100 (user left)
- EG010 (center)
- EG001 (user right)
- EG101 (user left and right)
- EG111 (user left, right and center)

More than one EC unit in a worksurface less than 48" in width is not recommended. No upcharge for cutout.

- NOTE: Cutouts for 18" deep worksurfaces will run perpendicular to user**
- NOTE: EC10 and EC11 units must be ordered separately.**
- Refer to page 214 for additional information.**

- Undersurface Electrical:

Specify the appropriate number below for the circuit number(s) desired for each duplex unit on your worksurface.

- P1 (circuit 1)
- P2 (circuit 2)
- PM (mix circuit 1 and circuit 2)

- NOTE: Two circuit system requires a hardwire infeed.**
- When Undersurface Electrical is specified one duplex unit, two jumpers and two H block connectors will be mounted to the underside of units less than 60" in width. Units 60" in width and wider will have two duplex units, two jumpers and two H-block connectors.
- NOTE: Infeed cables and additional jumper cables must be ordered separately. Refer to pages 215-217 for additional information.**

Edge Profile:



Eased (R6)

Corner and Nook pedestal restrictions:

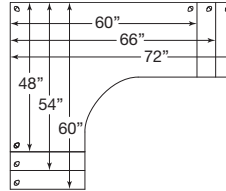

- 48" Side - Leg to Floor or Bracket to Tall Storage
- 54" Side - Leg to Floor, Bracket to Tall Storage or 9" wide pedestal
- 60" Side - Leg to Floor, Bracket to Tall Storage or 9" or 18" wide pedestal
- 66" Side - Leg to Floor, Bracket to Tall Storage or 9" or 18" wide pedestal
- 72" Side - Leg to Floor, Bracket to Tall Storage or 9", 18", 24" or 30" wide pedestal
- 78" Side - No restrictions

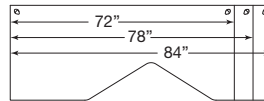

- 72" Wide, 6" Side - Leg to Floor
- 78" Wide, 12" Side - Leg to Floor or 9" wide pedestal
- 84" Wide, 18" Side - Leg to Floor, 9" or 18" wide pedestal

The letters in the chart below indicate the depth of each side on certain worksurfaces.

Ex: SST2484UFING-BA
 B = 24 left A = 18 right



Top Depth
A = 18" Deep
B = 24" Deep
C = 30" Deep
D = 36" Deep

WORKSURFACE
Rectangle
Grommets - Inset 6"

Description	① Model	D	W	H	CTN WT	CU FT	List Price	
36" Deep 	SST3696RECTGO · two grommets - left and right corners on approach side, inset 6" · 2 1/4" tall acrylic plenum on ends and approach side · 2" black wire management trough · left and right support options must be specified, see pages 132 and 138; unsupported span cannot exceed 78", leg to floor for both left and right cannot be specified · optional cutout for EC10 and EC11, see page 214 · optional undersurface electrical includes two duplex units	36	96	1 3/16	119	13	\$1,060	
		Undersurface Electrical Included List Price						\$1,424
	SST3690RECTGO · two grommets - left and right corners on approach side, inset 6" · 2 1/4" tall acrylic plenum on ends and approach side · 2" black wire management trough · left and right support options must be specified, see pages 132 and 138; unsupported span cannot exceed 78", leg to floor for both left and right cannot be specified · optional cutout for EC10 and EC11, see page 214 · optional undersurface electrical includes two duplex units	36	90	1 3/16	112	13	\$1,014	
	Undersurface Electrical Included List Price						\$1,373	
	SST3684RECTGO · two grommets - left and right corners on approach side, inset 6" · 2 1/4" tall acrylic plenum on ends and approach side · 2" black wire management trough · left and right support options must be specified, see pages 132 and 138; unsupported span cannot exceed 78", leg to floor for both left and right cannot be specified · optional cutout for EC10 and EC11, see page 214 · optional undersurface electrical includes two duplex units	36	84	1 3/16	104	12	\$958	
	Undersurface Electrical Included List Price						\$1,314	

SWISH

To Order, Specify:

- ① Model number
- ② Worksurface color
- ③ Product Options (see page 76)

② Laminate Color Options:

ALB	Alabaster	GRH	Graphite
AUT	Autumn	HGL	High Line
BLO	Blonde Echo	SHD	Shadow
BBN	Bourbon	SHE	Shea
BZW	Brazilwood	SLG	Slate Grey
BBL	Bridal Blanco	STU	Studio Teak
BRG	Brighton	TAU	Taupe
DWH	Designer White	VIN	Vintage
DOV	Dove Grey	WLH	Walnut Heights

Order Check List

page 76

Product Specifications

page 40

Power and Data Options

page 214

Undersurface Electrical Options

pages 215-217

WORKSURFACE
Rectangle
Grommets - Inset 6"

Description	① Model	D	W	H	CTN WT	CU FT	List Price	
36" Deep 	SST3678RECTGO · two grommets - left and right corners on approach side, inset 6" · 2 1/4" tall acrylic plenum on ends and approach side · 2" black wire management trough · left and right support options must be specified, see pages 132 and 138 · optional cutout for EC10 and EC11, see page 214 · optional undersurface electrical includes two duplex units	36	78	1 3/16	96	11	\$890	
		Undersurface Electrical Included List Price						\$1,243
	SST3672RECTGO · two grommets - left and right corners on approach side, inset 6" · 2 1/4" tall acrylic plenum on ends and approach side · 2" black wire management trough · left and right support options must be specified, see pages 132 and 138 · optional cutout for EC10 and EC11, see page 214 · optional undersurface electrical includes two duplex units	36	72	1 3/16	90	10	\$847	
		Undersurface Electrical Included List Price						\$1,195
	SST3666RECTGO · two grommets - left and right corners on approach side, inset 6" · 2 1/4" tall acrylic plenum on ends and approach side · 2" black wire management trough · left and right support options must be specified, see pages 132 and 138 · optional cutout for EC10 and EC11, see page 214 · optional undersurface electrical includes two duplex units	36	66	1 3/16	83	9	\$797	
	Undersurface Electrical Included List Price						\$1,140	
SST3660RECTGO · two grommets - left and right corners on approach side, inset 6" · 2 1/4" tall acrylic plenum on ends and approach side · 2" black wire management trough · left and right support options must be specified, see pages 132 and 138 · optional cutout for EC10 and EC11, see page 214 · optional undersurface electrical includes two duplex units	36	60	1 3/16	75	9	\$754		
	Undersurface Electrical Included List Price						\$1,094	

SWISH

WORKSURFACE
Rectangle
Grommets - Inset 6"

Description	① Model	D	W	H	CTN WT	CU FT	List Price
30" Deep 	SST3096RECTGO · two grommets - left and right corners on approach side, inset 6" · 2 1/4" tall acrylic plenum on ends and approach side · 2" black wire management trough · left and right support options must be specified, see pages 132 and 138; unsupported span cannot exceed 78", leg to floor for both left and right cannot be specified · optional cutout for EC10 and EC11, see page 214 · optional undersurface electrical includes two duplex units	30	96	1 3/16	100	11	\$964 Undersurface Electrical Included List Price \$1,329
	SST3090RECTGO · two grommets - left and right corners on approach side, inset 6" · 2 1/4" tall acrylic plenum on ends and approach side · 2" black wire management trough · left and right support options must be specified, see pages 132 and 138; unsupported span cannot exceed 78", leg to floor for both left and right cannot be specified · optional cutout for EC10 and EC11, see page 214 · optional undersurface electrical includes two duplex units	30	90	1 3/16	94	11	\$923 Undersurface Electrical Included List Price \$1,284
	SST3084RECTGO · two grommets - left and right corners on approach side, inset 6" · 2 1/4" tall acrylic plenum on ends and approach side · 2" black wire management trough · left and right support options must be specified, see pages 132 and 138; unsupported span cannot exceed 78", leg to floor for both left and right cannot be specified · optional cutout for EC10 and EC11, see page 214 · optional undersurface electrical includes two duplex units	30	84	1 3/16	88	10	\$875 Undersurface Electrical Included List Price \$1,231

SWISH

To Order, Specify:

- ① Model number
- ② Worksurface color
- ③ Product Options (see page 76)

② Laminate Color Options:

ALB Alabaster	GRH Graphite
AUT Autumn	HGL High Line
BLO Blonde Echo	SHD Shadow
BBN Bourbon	SHE Shea
BZW Brazilwood	SLG Slate Grey
BBL Bridal Blanco	STU Studio Teak
BRG Brighton	TAU Taupe
DWH Designer White	VIN Vintage
DOV Dove Grey	WLH Walnut Heights

Order Check List

- page 76
- Product Specifications**
page 40
- Power and Data Options**
page 214
- Undersurface Electrical Options**
pages 215-217

WORKSURFACE
Rectangle
Grommets - Inset 6"

Description	① Model	D	W	H	CTN WT	CU FT	List Price	
30" Deep 	SST3078RECTGO · two grommets - left and right corners on approach side, inset 6" · 2 1/4" tall acrylic plenum on ends and approach side · 2" black wire management trough · left and right support options must be specified, see pages 132 and 138 · optional cutout for EC10 and EC11, see page 214 · optional undersurface electrical includes two duplex units	30	78	1 3/16	82	9	\$812	
	Undersurface Electrical Included List Price							\$1,165
	SST3072RECTGO · two grommets - left and right corners on approach side, inset 6" · 2 1/4" tall acrylic plenum on ends and approach side · 2" black wire management trough · left and right support options must be specified, see pages 132 and 138 · optional cutout for EC10 and EC11, see page 214 · optional undersurface electrical includes two duplex units	30	72	1 3/16	76	9	\$773	
	Undersurface Electrical Included List Price							\$1,122
	SST3066RECTGO · two grommets - left and right corners on approach side, inset 6" · 2 1/4" tall acrylic plenum on ends and approach side · 2" black wire management trough · left and right support options must be specified, see pages 132 and 138 · optional cutout for EC10 and EC11, see page 214 · optional undersurface electrical includes two duplex units	30	66	1 3/16	70	8	\$729	
Undersurface Electrical Included List Price							\$1,071	
SST3060RECTGO · two grommets - left and right corners on approach side, inset 6" · 2 1/4" tall acrylic plenum on ends and approach side · 2" black wire management trough · left and right support options must be specified, see pages 132 and 138 · optional cutout for EC10 and EC11, see page 214 · optional undersurface electrical includes two duplex units	30	60	1 3/16	64	7	\$691		
Undersurface Electrical Included List Price							\$1,029	

SWISH

WORKSURFACE
Rectangle
Grommets - Inset 6"

Description	① Model	D	W	H	CTN WT	CU FT	List Price	
24" Deep 	SST2496RECTGO · two grommets - left and right corners on approach side, inset 6" · 2 1/4" tall acrylic plenum on ends and approach side · 2" black wire management trough · left and right support options must be specified, see pages 132 and 138; unsupported span cannot exceed 78", leg to floor for both left and right cannot be specified · optional cutout for EC10 and EC11, see page 214 · optional undersurface electrical includes two duplex units	24	96	1 3/16	82	9	\$871	
		Undersurface Electrical Included List Price						\$1,235
	SST2490RECTGO · two grommets - left and right corners on approach side, inset 6" · 2 1/4" tall acrylic plenum on ends and approach side · 2" black wire management trough · left and right support options must be specified, see pages 132 and 138; unsupported span cannot exceed 78", leg to floor for both left and right cannot be specified · optional cutout for EC10 and EC11, see page 214 · optional undersurface electrical includes two duplex units	24	90	1 3/16	77	9	\$834	
		Undersurface Electrical Included List Price						\$1,194
	SST2484RECTGO · two grommets - left and right corners on approach side, inset 6" · 2 1/4" tall acrylic plenum on ends and approach side · 2" black wire management trough · left and right support options must be specified, see pages 132 and 138; unsupported span cannot exceed 78", leg to floor for both left and right cannot be specified · optional cutout for EC10 and EC11, see page 214 · optional undersurface electrical includes two duplex units	24	84	1 3/16	72	8	\$790	
		Undersurface Electrical Included List Price						\$1,145
SST2478RECTGO · two grommets - left and right corners on approach side, inset 6" · 2 1/4" tall acrylic plenum on ends and approach side · 2" black wire management trough · left and right support options must be specified, see pages 132 and 138 · optional cutout for EC10 and EC11, see page 214 · optional undersurface electrical includes two duplex units	24	78	1 3/16	67	8	\$732		
	Undersurface Electrical Included List Price						\$1,085	
SST2472RECTGO · two grommets - left and right corners on approach side, inset 6" · 2 1/4" tall acrylic plenum on ends and approach side · 2" black wire management trough · left and right support options must be specified, see pages 132 and 138 · optional cutout for EC10 and EC11, see page 214 · optional undersurface electrical includes two duplex units	24	72	1 3/16	62	7	\$699		
	Undersurface Electrical Included List Price						\$1,047	

SWISH

To Order, Specify:

- ① Model number
- ② Worksurface color
- ③ Product Options (see page 76)

② Laminate Color Options:

ALB Alabaster	GRH Graphite
AUT Autumn	HGL High Line
BLO Blonde Echo	SHD Shadow
BBN Bourbon	SHE Shea
BZW Brazilwood	SLG Slate Grey
BBL Bridal Blanco	STU Studio Teak
BRG Brighton	TAU Taupe
DWH Designer White	VIN Vintage
DOV Dove Grey	WLH Walnut Heights

Order Check List

page 76

Product Specifications

page 40

Power and Data Options

page 214

Undersurface Electrical Options

pages 215-217

WORKSURFACE
Rectangle
Grommets - Inset 6"

Description	① Model	D	W	H	CTN WT	CU FT	List Price
24" Deep 	SST2466RECTGO · two grommets - left and right corners on approach side, inset 6" · 2 1/4" tall acrylic plenum on ends and approach side · 2" black wire management trough · left and right support options must be specified, see pages 132 and 138 · optional cutout for EC10 and EC11, see page 214 · optional undersurface electrical includes two duplex units	24	66	1 3/16	57	7	\$660
	· Undersurface Electrical Included List Price						\$1,002
	SST2460RECTGO · two grommets - left and right corners on approach side, inset 6" · 2 1/4" tall acrylic plenum on ends and approach side · 2" black wire management trough · left and right support options must be specified, see pages 132 and 138 · optional cutout for EC10 and EC11, see page 214 · optional undersurface electrical includes two duplex units	24	60	1 3/16	52	6	\$626
	· Undersurface Electrical Included List Price						\$964
	SST2454RECTGO · two grommets - left and right corners on approach side, inset 6" · 2 1/4" tall acrylic plenum on ends and approach side · 2" black wire management trough · left and right support options must be specified, see pages 132 and 138 · optional cutout for EC10 and EC11, see page 214 · optional undersurface electrical includes one duplex unit	24	54	1 3/16	47	6	\$586
	· Undersurface Electrical Included List Price						\$852
	SST2448RECTGO · two grommets - left and right corners on approach side, inset 6" · 2 1/4" tall acrylic plenum on ends and approach side · 2" black wire management trough standard · left and right support options must be specified, see pages 132 and 138 · optional cutout for EC10 and EC11, see page 214 · optional undersurface electrical includes one duplex unit	24	48	1 3/16	42	5	\$551
	· Undersurface Electrical Included List Price						\$812
	SST2442RECTGO · two grommets - left and right corners on approach side, inset 6" · 2 1/4" tall acrylic plenum on ends and approach side · 2" black wire management trough standard · left and right support options must be specified, see pages 132 and 138 · optional cutout for EC10 and EC11, see page 214 · optional undersurface electrical includes one duplex unit	24	42	1 3/16	36	4	\$478
	· Undersurface Electrical Included List Price						\$735
	SST2436RECTGO · two grommets - left and right corners on approach side, inset 6" · 2 1/4" tall acrylic plenum on ends and approach side · 2" black wire management trough standard · left and right support options must be specified, see pages 132 and 138 · optional cutout for EC10 and EC11, see page 214 · optional undersurface electrical includes one duplex unit	24	36	1 3/16	31	4	\$449
	· Undersurface Electrical Included List Price						\$661
	SST2430RECTGO · two grommets - left and right corners on approach side, inset 6" · 2 1/4" tall acrylic plenum on ends and approach side · 2" black wire management trough standard · left and right support options must be specified, see pages 132 and 138 · optional cutout for EC10 and EC11, see page 214 · optional undersurface electrical includes one duplex unit	24	30	1 3/16	26	3	\$422
	· Undersurface Electrical Included List Price						\$590

SWISH

WORKSURFACE
Rectangle
Grommets

Description	① Model	D	W	H	CTN WT	CU FT	List Price
36" Deep 	SST3696RECTG · two grommets - left and right corners on approach side · 2 1/4" tall acrylic plenum on ends and approach side · 2" black wire management trough · left and right support options must be specified, see pages 132 and 138; unsupported span cannot exceed 78", leg to floor for both left and right cannot be specified · optional cutout for EC10 and EC11, see page 214 · optional undersurface electrical includes two duplex units	36	96	1 3/16	119	13	\$1,060 Undersurface Electrical Included List Price \$1,424
	SST3690RECTG · two grommets - left and right corners on approach side · 2 1/4" tall acrylic plenum on ends and approach side · 2" black wire management trough · left and right support options must be specified, see pages 132 and 138; unsupported span cannot exceed 78", leg to floor for both left and right cannot be specified · optional cutout for EC10 and EC11, see page 214 · optional undersurface electrical includes two duplex units	36	90	1 3/16	112	13	\$1,014 Undersurface Electrical Included List Price \$1,373
	SST3684RECTG · two grommets - left and right corners on approach side · 2 1/4" tall acrylic plenum on ends and approach side · 2" black wire management trough · left and right support options must be specified, see pages 132 and 138; unsupported span cannot exceed 78", leg to floor for both left and right cannot be specified · optional cutout for EC10 and EC11, see page 214 · optional undersurface electrical includes two duplex units	36	84	1 3/16	104	12	\$958 Undersurface Electrical Included List Price \$1,314

SWISH

To Order, Specify:

- ① Model number
- ② Worksurface color
- ③ Product Options (see page 76)

② Laminate Color Options:

ALB Alabaster	GRH Graphite
AUT Autumn	HGL High Line
BLO Blonde Echo	SHD Shadow
BBN Bourbon	SHE Shea
BZW Brazilwood	SLG Slate Grey
BBL Bridal Blanco	STU Studio Teak
BRG Brighton	TAU Taupe
DWH Designer White	VIN Vintage
DOV Dove Grey	WLH Walnut Heights

Order Check List

page 76

Product Specifications

page 40

Power and Data Options

page 214

Undersurface Electrical Options

pages 215-217

WORKSURFACE

Rectangle
Grommets

Description	① Model	D	W	H	CTN WT	CU FT	List Price
<p>36" Deep</p>	<p>SST3678RECTG</p> <ul style="list-style-type: none"> · two grommets - left and right corners on approach side · 2 1/4" tall acrylic plenum on ends and approach side · 2" black wire management trough · left and right support options must be specified, see pages 132 and 138 · optional cutout for EC10 and EC11, see page 214 · optional undersurface electrical includes two duplex units 	36	78	1 3/16	96	11	\$890
		Undersurface Electrical Included List Price					\$1,243
	<p>SST3672RECTG</p> <ul style="list-style-type: none"> · two grommets - left and right corners on approach side · 2 1/4" tall acrylic plenum on ends and approach side · 2" black wire management trough · left and right support options must be specified, see pages 132 and 138 · optional cutout for EC10 and EC11, see page 214 · optional undersurface electrical includes two duplex units 	36	72	1 3/16	90	10	\$847
		Undersurface Electrical Included List Price					\$1,195
	<p>SST3666RECTG</p> <ul style="list-style-type: none"> · two grommets - left and right corners on approach side · 2 1/4" tall acrylic plenum on ends and approach side · 2" black wire management trough · left and right support options must be specified, see pages 132 and 138 · optional cutout for EC10 and EC11, see page 214 · optional undersurface electrical includes two duplex units 	36	66	1 3/16	83	9	\$797
	Undersurface Electrical Included List Price					\$1,140	
<p>SST3660RECTG</p> <ul style="list-style-type: none"> · two grommets - left and right corners on approach side · 2 1/4" tall acrylic plenum on ends and approach side · 2" black wire management trough · left and right support options must be specified, see pages 132 and 138 · optional cutout for EC10 and EC11, see page 214 · optional undersurface electrical includes two duplex units 	36	60	1 3/16	75	9	\$754	
	Undersurface Electrical Included List Price					\$1,094	

SWISH

WORKSURFACE
Rectangle
Grommets

Description	① Model	D	W	H	CTN WT	CU FT	List Price
30" Deep 	SST3096RECTG	30	96	1 3/16	100	11	\$964
	<ul style="list-style-type: none"> two grommets - left and right corners on approach side 2 1/4" tall acrylic plenum on ends and approach side 2" black wire management trough left and right support options must be specified, see pages 132 and 138; unsupported span cannot exceed 78", leg to floor for both left and right cannot be specified optional cutout for EC10 and EC11, see page 214 optional undersurface electrical includes two duplex units 	Undersurface Electrical Included List Price					\$1,329
	SST3090RECTG	30	90	1 3/16	94	11	\$923
	<ul style="list-style-type: none"> two grommets - left and right corners on approach side 2 1/4" tall acrylic plenum on ends and approach side 2" black wire management trough left and right support options must be specified, see pages 132 and 138; unsupported span cannot exceed 78", leg to floor for both left and right cannot be specified optional cutout for EC10 and EC11, see page 214 optional undersurface electrical includes two duplex units 	Undersurface Electrical Included List Price					\$1,284
	SST3084RECTG	30	84	1 3/16	88	10	\$875
	<ul style="list-style-type: none"> two grommets - left and right corners on approach side 2 1/4" tall acrylic plenum on ends and approach side 2" black wire management trough left and right support options must be specified, see pages 132 and 138; unsupported span cannot exceed 78", leg to floor for both left and right cannot be specified optional cutout for EC10 and EC11, see page 214 optional undersurface electrical includes two duplex units 	Undersurface Electrical Included List Price					\$1,231

SWISH

To Order, Specify:

- ① Model number
- ② Worksurface color
- ③ Product Options (see page 76)

② Laminate Color Options:

ALB	Alabaster	GRH	Graphite
AUT	Autumn	HGL	High Line
BLO	Blonde Echo	SHD	Shadow
BBN	Bourbon	SHE	Shea
BZW	Brazilwood	SLG	Slate Grey
BBL	Bridal Blanco	STU	Studio Teak
BRG	Brighton	TAU	Taupe
DWH	Designer White	VIN	Vintage
DOV	Dove Grey	WLH	Walnut Heights

Order Check List

page 76

Product Specifications

page 40

Power and Data Options

page 214

Undersurface Electrical Options

pages 215-217

WORKSURFACE

Rectangle
Grommets

Description	① Model	D	W	H	CTN WT	CU FT	List Price
30" Deep 	SST3078RECTG · two grommets - left and right corners on approach side · 2 1/4" tall acrylic plenum on ends and approach side · 2" black wire management trough · left and right support options must be specified, see pages 132 and 138 · optional cutout for EC10 and EC11, see page 214 · optional undersurface electrical includes two duplex units	30	78	1 3/16	82	9	\$812 Undersurface Electrical Included List Price \$1,165
	SST3072RECTG · two grommets - left and right corners on approach side · 2 1/4" tall acrylic plenum on ends and approach side · 2" black wire management trough · left and right support options must be specified, see pages 132 and 138 · optional cutout for EC10 and EC11, see page 214 · optional undersurface electrical includes two duplex units	30	72	1 3/16	76	9	\$773 Undersurface Electrical Included List Price \$1,122
	SST3066RECTG · two grommets - left and right corners on approach side · 2 1/4" tall acrylic plenum on ends and approach side · 2" black wire management trough · left and right support options must be specified, see pages 132 and 138 · optional cutout for EC10 and EC11, see page 214 · optional undersurface electrical includes two duplex units	30	66	1 3/16	70	8	\$729 Undersurface Electrical Included List Price \$1,071
	SST3060RECTG · two grommets - left and right corners on approach side · 2 1/4" tall acrylic plenum on ends and approach side · 2" black wire management trough · left and right support options must be specified, see pages 132 and 138 · optional cutout for EC10 and EC11, see page 214 · optional undersurface electrical includes two duplex units	30	60	1 3/16	64	7	\$691 Undersurface Electrical Included List Price \$1,029

SWISH

WORKSURFACE
Rectangle
Grommets

Description	① Model	D	W	H	CTN WT	CU FT	List Price
24" Deep 	SST2496RECTG	24	96	1 3/16	82	9	\$871
	<ul style="list-style-type: none"> two grommets - left and right corners on approach side 2 1/4" tall acrylic plenum on ends and approach side 2" black wire management trough left and right support options must be specified, see pages 132 and 138; unsupported span cannot exceed 78", leg to floor for both left and right cannot be specified optional cutout for EC10 and EC11, see page 214 optional undersurface electrical includes two duplex units 	Undersurface Electrical Included List Price		\$1,235			
	SST2490RECTG	24	90	1 3/16	77	9	\$834
	<ul style="list-style-type: none"> two grommets - left and right corners on approach side 2 1/4" tall acrylic plenum on ends and approach side 2" black wire management trough left and right support options must be specified, see pages 132 and 138; unsupported span cannot exceed 78", leg to floor for both left and right cannot be specified optional cutout for EC10 and EC11, see page 214 optional undersurface electrical includes two duplex units 	Undersurface Electrical Included List Price		\$1,194			
	SST2484RECTG	24	84	1 3/16	72	8	\$790
	<ul style="list-style-type: none"> two grommets - left and right corners on approach side 2 1/4" tall acrylic plenum on ends and approach side 2" black wire management trough left and right support options must be specified, see pages 132 and 138; unsupported span cannot exceed 78", leg to floor for both left and right cannot be specified optional cutout for EC10 and EC11, see page 214 optional undersurface electrical includes two duplex units 	Undersurface Electrical Included List Price		\$1,145			
	SST2478RECTG	24	78	1 3/16	67	8	\$732
	<ul style="list-style-type: none"> two grommets - left and right corners on approach side 2 1/4" tall acrylic plenum on ends and approach side 2" black wire management trough left and right support options must be specified, see pages 132 and 138 optional cutout for EC10 and EC11, see page 214 optional undersurface electrical includes two duplex units 	Undersurface Electrical Included List Price		\$1,085			
	SST2472RECTG	24	72	1 3/16	62	7	\$699
	<ul style="list-style-type: none"> two grommets - left and right corners on approach side 2 1/4" tall acrylic plenum on ends and approach side 2" black wire management trough left and right support options must be specified, see pages 132 and 138 optional cutout for EC10 and EC11, see page 214 optional undersurface electrical includes two duplex units 	Undersurface Electrical Included List Price		\$1,047			

SWISH

To Order, Specify:

- ① Model number
- ② Worksurface color
- ③ Product Options (see page 76)

② Laminate Color Options:

ALB Alabaster	GRH Graphite
AUT Autumn	HGL High Line
BLO Blonde Echo	SHD Shadow
BBN Bourbon	SHE Shea
BZW Brazilwood	SLG Slate Grey
BBL Bridal Blanco	STU Studio Teak
BRG Brighton	TAU Taupe
DWH Designer White	VIN Vintage
DOV Dove Grey	WLH Walnut Heights

Order Check List

page 76

Product Specifications

page 40

Power and Data Options

page 214

Undersurface Electrical Options

pages 215-217

WORKSURFACE

Rectangle
Grommets

Description	① Model	D	W	H	CTN WT	CU FT	List Price
24" Deep 	SST2466RECTG • two grommets - left and right corners on approach side • 2 1/4" tall acrylic plenum on ends and approach side • 2" black wire management trough • left and right support options must be specified, see pages 132 and 138 • optional cutout for EC10 and EC11, see page 214 • optional undersurface electrical includes two duplex units	24	66	1 3/16	57	7	\$660
		Undersurface Electrical Included List Price					\$1,002
	SST2460RECTG • two grommets - left and right corners on approach side • 2 1/4" tall acrylic plenum on ends and approach side • 2" black wire management trough • left and right support options must be specified, see pages 132 and 138 • optional cutout for EC10 and EC11, see page 214 • optional undersurface electrical includes two duplex units	24	60	1 3/16	52	6	\$626
		Undersurface Electrical Included List Price					\$964
	SST2454RECTG • two grommets - left and right corners on approach side • 2 1/4" tall acrylic plenum on ends and approach side • 2" black wire management trough • left and right support options must be specified, see pages 132 and 138 • optional cutout for EC10 and EC11, see page 214 • optional undersurface electrical includes one duplex unit	24	54	1 3/16	47	6	\$586
		Undersurface Electrical Included List Price					\$852
	SST2448RECTG • two grommets - left and right corners on approach side • 2 1/4" tall acrylic plenum on ends and approach side • 2" black wire management trough • left and right support options must be specified, see pages 132 and 138 • optional cutout for EC10 and EC11, see page 214 • optional undersurface electrical includes one duplex unit	24	48	1 3/16	42	5	\$551
		Undersurface Electrical Included List Price					\$812
	SST2442RECTG • two grommets - left and right corners on approach side • 2 1/4" tall acrylic plenum on ends and approach side • 2" black wire management trough • left and right support options must be specified, see pages 132 and 138 • optional cutout for EC10 and EC11, see page 214 • optional undersurface electrical includes one duplex unit	24	42	1 3/16	36	4	\$478
		Undersurface Electrical Included List Price					\$735
SST2436RECTG • two grommets - left and right corners on approach side • 2 1/4" tall acrylic plenum on ends and approach side • 2" black wire management trough • left and right support options must be specified, see pages 132 and 138 • optional cutout for EC10 and EC11, see page 214 • optional undersurface electrical includes one duplex unit	24	36	1 3/16	31	4	\$449	
	Undersurface Electrical Included List Price					\$661	
SST2430RECTG • two grommets - left and right corners on approach side • 2 1/4" tall acrylic plenum on ends and approach side • 2" black wire management trough • left and right support options must be specified, see pages 132 and 138 • optional cutout for EC10 and EC11, see page 214 • optional undersurface electrical includes one duplex unit	24	30	1 3/16	26	3	\$422	
	Undersurface Electrical Included List Price					\$590	
SST2418RECTG • two grommets - left and right corners on approach side • 2 1/4" tall acrylic plenum on ends and approach side • 2" black wire management trough • left and right support options must be specified, see pages 132 and 138 • optional cutout for EC10 and EC11, see page 214 • undersurface electrical not available	24	18	1 3/16	17	2	\$381	

SWISH

WORKSURFACE
Rectangle
Grommets

Description	① Model	D	W	H	CTN WT	CU FT	List Price	
18" Deep 	SST1896RECTG · two grommets - left and right corners on approach side · 2 1/4" tall acrylic plenum on ends and approach side · 2" black wire management trough · left and right support options must be specified, see pages 132 and 138; unsupported span cannot exceed 78", leg to floor for both left and right cannot be specified · optional cutout for EC10 and EC11, see page 214; due to width of top, cutout will run perpendicular to user · optional undersurface electrical includes two duplex units	18	96	1 3/16	64	7	\$777	
		Undersurface Electrical Included List Price						\$1,142
	SST1890RECTG · two grommets - left and right corners on approach side · 2 1/4" tall acrylic plenum on ends and approach side · 2" black wire management trough · left and right support options must be specified, see pages 132 and 138; unsupported span cannot exceed 78", leg to floor for both left and right cannot be specified · optional cutout for EC10 and EC11, see page 214; due to width of top, cutout will run perpendicular to user · optional undersurface electrical includes two duplex units	18	90	1 3/16	60	7	\$746	
		Undersurface Electrical Included List Price						\$1,105
	SST1884RECTG · two grommets - left and right corners on approach side · 2 1/4" tall acrylic plenum on ends and approach side · 2" black wire management trough · left and right support options must be specified, see pages 132 and 138; unsupported span cannot exceed 78", leg to floor for both left and right cannot be specified · optional cutout for EC10 and EC11, see page 214; due to width of top, cutout will run perpendicular to user · optional undersurface electrical includes two duplex units	18	84	1 3/16	56	6	\$708	
		Undersurface Electrical Included List Price						\$1,063

HSIMS

To Order, Specify:

- ① Model number
- ② Worksurface color
- ③ Product Options (see page 76)

② Laminate Color Options:

ALB	Alabaster	GRH	Graphite
AUT	Autumn	HGL	High Line
BLO	Blonde Echo	SHD	Shadow
BBN	Bourbon	SHE	Shea
BZW	Brazilwood	SLG	Slate Grey
BBL	Bridal Blanco	STU	Studio Teak
BRG	Brighton	TAU	Taupe
DWH	Designer White	VIN	Vintage
DOV	Dove Grey	WLH	Walnut Heights

Order Check List

page 76

Product Specifications

page 40

Power and Data Options

page 214

Undersurface Electrical Options

pages 215-217

WORKSURFACE

Rectangle
Grommets

Description	① Model	D	W	H	CTN WT	CU FT	List Price
18" Deep 	SST1878RECTG · two grommets - left and right corners on approach side · 2 1/4" tall acrylic plenum on ends and approach side · 2" black wire management trough · left and right support options must be specified, see pages 132 and 138 · optional cutout for EC10 and EC11, see page 214; due to width of top, cutout will run perpendicular to user · optional undersurface electrical includes two duplex units	18	78	1 3/16	52	6	\$656
							Undersurface Electrical Included List Price \$1,007
	SST1872RECTG · two grommets - left and right corners on approach side · 2 1/4" tall acrylic plenum on ends and approach side · 2" black wire management trough · left and right support options must be specified, see pages 132 and 138 · optional cutout for EC10 and EC11, see page 214; due to width of top, cutout will run perpendicular to user · optional undersurface electrical includes two duplex units	18	72	1 3/16	48	6	\$626
							Undersurface Electrical Included List Price \$974
	SST1866RECTG · two grommets - left and right corners on approach side · 2 1/4" tall acrylic plenum on ends and approach side · 2" black wire management trough · left and right support options must be specified, see pages 132 and 138 · optional cutout for EC10 and EC11, see page 214; due to width of top, cutout will run perpendicular to user · optional undersurface electrical includes two duplex units	18	66	1 3/16	45	5	\$592
							Undersurface Electrical Included List Price \$935
	SST1860RECTG · two grommets - left and right corners on approach side · 2 1/4" tall acrylic plenum on ends and approach side · 2" black wire management trough · left and right support options must be specified, see pages 132 and 138 · optional cutout for EC10 and EC11, see page 214; due to width of top, cutout will run perpendicular to user · optional undersurface electrical includes two duplex units	18	60	1 3/16	41	5	\$565
							Undersurface Electrical Included List Price \$905
	SST1854RECTG · two grommets - left and right corners on approach side · 2 1/4" tall acrylic plenum on ends and approach side · 2" black wire management trough · left and right support options must be specified, see pages 132 and 138 · optional cutout for EC10 and EC11, see page 214; due to width of top, cutout will run perpendicular to user · optional undersurface electrical includes one duplex unit	18	54	1 3/16	37	4	\$530
							Undersurface Electrical Included List Price \$796

SWISH

WORKSURFACE
Rectangle
Grommets

Description	① Model	D	W	H	CTN WT	CU FT	List Price	
18" Deep 	SST1848RECTG · two grommets - left and right corners on approach side · 2 1/4" tall acrylic plenum on ends and approach side · 2" black wire management trough · left and right support options must be specified, see pages 132 and 138 · optional cutout for EC10 and EC11, see page 214; due to width of top, cutout will run perpendicular to user · optional undersurface electrical includes one duplex unit	18	48	1 3/16	33	4	\$499	
		Undersurface Electrical Included List Price						\$762
	SST1842RECTG · two grommets - left and right corners on approach side · 2 1/4" tall acrylic plenum on ends and approach side · 2" black wire management trough · left and right support options must be specified, see pages 132 and 138 · optional cutout for EC10 and EC11, see page 214; due to width of top, cutout will run perpendicular to user · optional undersurface electrical includes one duplex unit	18	42	1 3/16	28	4	\$431	
		Undersurface Electrical Included List Price						\$689
	SST1836RECTG · two grommets - left and right corners on approach side · 2 1/4" tall acrylic plenum on ends and approach side · 2" black wire management trough · left and right support options must be specified, see pages 132 and 138 · optional cutout for EC10 and EC11, see page 214; due to width of top, cutout will run perpendicular to user · optional undersurface electrical includes one duplex unit	18	36	1 3/16	24	3	\$407	
		Undersurface Electrical Included List Price						\$620
	SST1830RECTG · two grommets - left and right corners on approach side · 2 1/4" tall acrylic plenum on ends and approach side · 2" black wire management trough · left and right support options must be specified, see pages 132 and 138 · optional cutout for EC10 and EC11, see page 214; due to width of top, cutout will run perpendicular to user · optional undersurface electrical includes one duplex unit	18	30	1 3/16	21	3	\$386	
		Undersurface Electrical Included List Price						\$554
	SST1818RECTG · two grommets - left and right corners on approach side · 2 1/4" tall acrylic plenum on ends and approach side · 2" black wire management trough · left and right support options must be specified, see pages 132 and 138 · optional cutout for EC10 and EC11, see page 214; due to width of top, cutout will run perpendicular to user · undersurface electrical not available	18	18	1 3/16	14	2	\$367	

To Order, Specify:

- ① Model number
- ② Worksurface color
- ③ Product Options (see page 76)

② Laminate Color Options:

ALB Alabaster	GRH Graphite
AUT Autumn	HGL High Line
BLO Blonde Echo	SHD Shadow
BBN Bourbon	SHE Shea
BZW Brazilwood	SLG Slate Grey
BBL Bridal Blanco	STU Studio Teak
BRG Brighton	TAU Taupe
DWH Designer White	VIN Vintage
DOV Dove Grey	WLH Walnut Heights

Order Check List

page 76

Product Specifications

page 40

Power and Data Options

page 214

Undersurface Electrical Options

pages 215-217

WORKSURFACE
Fin - Arc User Side
Grommets - Inset 6"

Description	Model	Left D	Right D	W	H	CTN WT	CU FT	List Price
36" Deep 	SST3684UFINGO-DC	36	30	84	1 3/16	96	12	\$1,500
	<ul style="list-style-type: none"> two grommets - left and right corners on approach side, inset 6" 2 1/4" tall acrylic plenum on ends and approach side 2" black wire management trough left and right support options must be specified, see pages 132 and 138 unsupported span cannot exceed 78", leg to floor for both left and right cannot be specified optional cutout for EC10 and EC11, see page 214 optional undersurface electrical includes two duplex units 		Undersurface Electrical Included List Price		\$1,855			
	SST3678UFINGO-DC	36	30	78	1 3/16	90	11	\$1,436
	<ul style="list-style-type: none"> two grommets - left and right corners on approach side, inset 6" 2 1/4" tall acrylic plenum on ends and approach side 2" black wire management trough left and right support options must be specified, see pages 132 and 138 optional cutout for EC10 and EC11, see page 214 optional undersurface electrical includes two duplex units 		Undersurface Electrical Included List Price		\$1,789			
	SST3672UFINGO-DC	36	30	72	1 3/16	83	10	\$1,293
<ul style="list-style-type: none"> two grommets - left and right corners on approach side, inset 6" 2 1/4" tall acrylic plenum on ends and approach side 2" black wire management trough left and right support options must be specified, see pages 132 and 138 optional cutout for EC10 and EC11, see page 214 optional undersurface electrical includes two duplex units 		Undersurface Electrical Included List Price		\$1,642				
36" Deep 	SST3666UFINGO-DC	36	30	66	1 3/16	76	9	\$1,274
	<ul style="list-style-type: none"> two grommets - left and right corners on approach side, inset 6" 2 1/4" tall acrylic plenum on ends and approach side 2" black wire management trough left and right support options must be specified, see pages 132 and 138 optional cutout for EC10 and EC11, see page 214 optional undersurface electrical includes two duplex units 		Undersurface Electrical Included List Price		\$1,616			
	SST3684UFINGO-CD	30	36	84	1 3/16	96	12	\$1,500
	<ul style="list-style-type: none"> two grommets - left and right corners on approach side, inset 6" 2 1/4" tall acrylic plenum on ends and approach side 2" black wire management trough left and right support options must be specified, see pages 132 and 138 unsupported span cannot exceed 78", leg to floor for both left and right cannot be specified optional cutout for EC10 and EC11, see page 214 optional undersurface electrical includes two duplex units 		Undersurface Electrical Included List Price		\$1,855			
	SST3678UFINGO-CD	30	36	78	1 3/16	90	11	\$1,436
<ul style="list-style-type: none"> two grommets - left and right corners on approach side, inset 6" 2 1/4" tall acrylic plenum on ends and approach side 2" black wire management trough left and right support options must be specified, see pages 132 and 138 optional cutout for EC10 and EC11, see page 214 optional undersurface electrical includes two duplex units 		Undersurface Electrical Included List Price		\$1,789				
30" Deep 	SST3672UFINGO-CD	30	36	72	1 3/16	83	10	\$1,293
	<ul style="list-style-type: none"> two grommets - left and right corners on approach side, inset 6" 2 1/4" tall acrylic plenum on ends and approach side 2" black wire management trough left and right support options must be specified, see pages 132 and 138 optional cutout for EC10 and EC11, see page 214 optional undersurface electrical includes two duplex units 		Undersurface Electrical Included List Price		\$1,642			
	SST3666UFINGO-CD	30	36	66	1 3/16	76	9	\$1,274
	<ul style="list-style-type: none"> two grommets - left and right corners on approach side 2 1/4" tall acrylic plenum on ends and approach side 2" black wire management trough left and right support options must be specified, see pages 132 and 138 optional cutout for EC10 and EC11, see page 214 optional undersurface electrical includes two duplex units 		Undersurface Electrical Included List Price		\$1,616			

WORKSURFACE
Fin - Arc User Side
Grommets - Inset 6"

Description	① Model	Left D	Right D	W	H	CTN WT	CU FT	List Price
30" Deep 	SST3084UFINGO-CB	30	24	84	1 3/16	80	10	\$1,406
	<ul style="list-style-type: none"> two grommets - left and right corners on approach side, inset 6" 2 1/4" tall acrylic plenum on ends and approach side 2" black wire management trough left and right support options must be specified, see pages 132 and 138 unsupported span cannot exceed 78", leg to floor for both left and right cannot be specified optional cutout for EC10 and EC11, see page 214 optional undersurface electrical includes two duplex units 	Undersurface Electrical Included List Price			\$1,762			
	SST3078UFINGO-CB	30	24	78	1 3/16	75	9	\$1,332
	<ul style="list-style-type: none"> two grommets - left and right corners on approach side, inset 6" 2 1/4" tall acrylic plenum on ends and approach side 2" black wire management trough left and right support options must be specified, see pages 132 and 138 optional cutout for EC10 and EC11, see page 214 optional undersurface electrical includes two duplex units 	Undersurface Electrical Included List Price			\$1,685			
	SST3072UFINGO-CB	30	24	72	1 3/16	69	9	\$1,200
	<ul style="list-style-type: none"> two grommets - left and right corners on approach side, inset 6" 2 1/4" tall acrylic plenum on ends and approach side 2" black wire management trough left and right support options must be specified, see pages 132 and 138 optional cutout for EC10 and EC11, see page 214 optional undersurface electrical includes two duplex units 	Undersurface Electrical Included List Price			\$1,546			
	SST3066UFINGO-CB	30	24	66	1 3/16	64	8	\$1,178
	<ul style="list-style-type: none"> two grommets - left and right corners on approach side, inset 6" 2 1/4" tall acrylic plenum on ends and approach side 2" black wire management trough left and right support options must be specified, see pages 132 and 138 optional cutout for EC10 and EC11, see page 214 optional undersurface electrical includes two duplex units 	Undersurface Electrical Included List Price			\$1,521			

SWISH

To Order, Specify:

- ① Model number
- ② Worksurface color
- ③ Product Options (see page 76)

② Laminate Color Options:

ALB Alabaster	GRH Graphite
AUT Autumn	HGL High Line
BLO Blonde Echo	SHD Shadow
BBN Bourbon	SHE Shea
BZW Brazilwood	SLG Slate Grey
BBL Bridal Blanco	STU Studio Teak
BRG Brighton	TAU Taupe
DWH Designer White	VIN Vintage
DOV Dove Grey	WLH Walnut Heights

Order Check List

page 76

Product Specifications

page 40

Power and Data Options

page 214

Undersurface Electrical Options

pages 215-217

WORKSURFACE
 Fin - Arc User Side
 Grommets - Inset 6"

Description	① Model	Left D	Right D	W	H	CTN WT	CU FT	List Price	
30" Deep 	SST3084UFINGO-BC	24	30	84	1 3/16	80	10	\$1,406	
	<ul style="list-style-type: none"> two grommets - left and right corners on approach side, inset 6" 2 1/4" tall acrylic plenum on ends and approach side 2" black wire management trough left and right support options must be specified, see pages 132 and 138 unsupported span cannot exceed 78", leg to floor for both left and right cannot be specified optional cutout for EC10 and EC11, see page 214 optional undersurface electrical includes two duplex units 								Undersurface Electrical Included List Price \$1,762
	SST3078UFINGO-BC	24	30	78	1 3/16	75	9	\$1,332	
	<ul style="list-style-type: none"> two grommets - left and right corners on approach side, inset 6" 2 1/4" tall acrylic plenum on ends and approach side 2" black wire management trough left and right support options must be specified, see pages 132 and 138 optional cutout for EC10 and EC11, see page 214 optional undersurface electrical includes two duplex units 								Undersurface Electrical Included List Price \$1,685
	SST3072UFINGO-BC	24	30	72	1 3/16	69	9	\$1,200	
	<ul style="list-style-type: none"> two grommets - left and right corners on approach side, inset 6" 2 1/4" tall acrylic plenum on ends and approach side 2" black wire management trough left and right support options must be specified, see pages 132 and 138 optional cutout for EC10 and EC11, see page 214 optional undersurface electrical includes two duplex units 								Undersurface Electrical Included List Price \$1,546
	SST3066UFINGO-BC	24	30	66	1 3/16	64	8	\$1,178	
	<ul style="list-style-type: none"> two grommets - left and right corners on approach side, inset 6" 2 1/4" tall acrylic plenum on ends and approach side 2" black wire management trough left and right support options must be specified, see pages 132 and 138 optional cutout for EC10 and EC11, see page 214 optional undersurface electrical includes two duplex units 								Undersurface Electrical Included List Price \$1,521

SWISH

WORKSURFACE
Fin - Arc User Side
Grommets

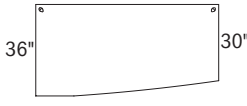
Description	1 Model	Left D	Right D	W	H	CTN WT	CU FT	List Price
36" Deep 	SST3684UFING-DC · two grommets - left and right corners on approach side · 2 1/4" tall acrylic plenum on ends and approach side · 2" black wire management trough · left and right support options must be specified, see pages 132 and 138; unsupported span cannot exceed 78", leg to floor for both left and right cannot be specified · optional cutout for EC10 and EC11, see page 214 · optional undersurface electrical includes two duplex units	36	30	84	1 3/16	96	12	\$1,500 Undersurface Electrical Included List Price \$1,855
	SST3678UFING-DC · two grommets - left and right corners on approach side · 2 1/4" tall acrylic plenum on ends and approach side · 2" black wire management trough · left and right support options must be specified, see pages 132 and 138 · optional cutout for EC10 and EC11, see page 214 · optional undersurface electrical includes two duplex units	36	30	78	1 3/16	90	11	\$1,436 Undersurface Electrical Included List Price \$1,789
	SST3672UFING-DC · two grommets - left and right corners on approach side · 2 1/4" tall acrylic plenum on ends and approach side · 2" black wire management trough · left and right support options must be specified, see pages 132 and 138 · optional cutout for EC10 and EC11, see page 214 · optional undersurface electrical includes two duplex units	36	30	72	1 3/16	83	10	\$1,293 Undersurface Electrical Included List Price \$1,642
	SST3666UFING-DC · two grommets - left and right corners on approach side · 2 1/4" tall acrylic plenum on ends and approach side · 2" black wire management trough · left and right support options must be specified, see pages 132 and 138 · optional cutout for EC10 and EC11, see page 214 · optional undersurface electrical includes two duplex units	36	30	66	1 3/16	76	9	\$1,274 Undersurface Electrical Included List Price \$1,616

SWISH

To Order, Specify:

- 1 Model number
- 2 Worksurface color
- 3 Product Options (see page 76)

2 Laminate Color Options:

ALB Alabaster	GRH Graphite
AUT Autumn	HGL High Line
BLO Blonde Echo	SHD Shadow
BBN Bourbon	SHE Shea
BZW Brazilwood	SLG Slate Grey
BBL Bridal Blanco	STU Studio Teak
BRG Brighton	TAU Taupe
DWH Designer White	VIN Vintage
DOV Dove Grey	WLH Walnut Heights

Order Check List

page 76

Product Specifications

page 40

Power and Data Options

page 214

Undersurface Electrical Options

pages 215-217

WORKSURFACE

Fin - Arc User Side
Grommets

Description	① Model	Left D	Right D	W	H	CTN WT	CU FT	List Price
36" Deep 	SST3684UFING-CD · two grommets - left and right corners on approach side · 2 ¼" tall acrylic plenum on ends and approach side · 2" black wire management trough · left and right support options must be specified, see pages 132 and 138; unsupported span cannot exceed 78", leg to floor for both left and right cannot be specified · optional cutout for EC10 and EC11, see page 214 · optional undersurface electrical includes two duplex units	30	36	84	1 ¾	96	12	\$1,500
								Undersurface Electrical Included List Price \$1,855
	SST3678UFING-CD · two grommets - left and right corners on approach side · 2 ¼" tall acrylic plenum on ends and approach side · 2" black wire management trough · left and right support options must be specified, see pages 132 and 138 · optional cutout for EC10 and EC11, see page 214 · optional undersurface electrical includes two duplex units	30	36	78	1 ¾	90	11	\$1,436
								Undersurface Electrical Included List Price \$1,789
	SST3672UFING-CD · two grommets - left and right corners on approach side · 2 ¼" tall acrylic plenum on ends and approach side · 2" black wire management trough · left and right support options must be specified, see pages 132 and 138 · optional cutout for EC10 and EC11, see page 214 · optional undersurface electrical includes two duplex units	30	36	72	1 ¾	83	10	\$1,293
								Undersurface Electrical Included List Price \$1,642
	SST3666UFING-CD · two grommets - left and right corners on approach side · 2 ¼" tall acrylic plenum on ends and approach side · 2" black wire management trough · left and right support options must be specified, see pages 132 and 138 · optional cutout for EC10 and EC11, see page 214 · optional undersurface electrical includes two duplex units	30	36	66	1 ¾	76	9	\$1,274
								Undersurface Electrical Included List Price \$1,616

SWISH

WORKSURFACE
Fin - Arc User Side
Grommets

Description	① Model	Left D	Right D	W	H	CTN WT	CU FT	List Price
30" Deep 	SST3084UFING-CB	30	24	84	1 3/16	80	10	\$1,406
	<ul style="list-style-type: none"> · two grommets - left and right corners on approach side · 2 1/4" tall acrylic plenum on ends and approach side · 2" black wire management trough · left and right support options must be specified, see pages 132 and 138; unsupported span cannot exceed 78", leg to floor for both left and right cannot be specified · optional cutout for EC10 and EC11, see page 214 · optional undersurface electrical includes two duplex units 	Undersurface Electrical Included List Price						\$1,762
	SST3078UFING-CB	30	24	78	1 3/16	75	9	\$1,332
	<ul style="list-style-type: none"> · two grommets - left and right corners on approach side · 2 1/4" tall acrylic plenum on ends and approach side · 2" black wire management trough · left and right support options must be specified, see pages 132 and 138 · optional cutout for EC10 and EC11, see page 214 · optional undersurface electrical includes two duplex units 	Undersurface Electrical Included List Price						\$1,685
	SST3072UFING-CB	30	24	72	1 3/16	69	9	\$1,200
	<ul style="list-style-type: none"> · two grommets - left and right corners on approach side · 2 1/4" tall acrylic plenum on ends and approach side · 2" black wire management trough · left and right support options must be specified, see pages 132 and 138 · optional cutout for EC10 and EC11, see page 214 · optional undersurface electrical includes two duplex units 	Undersurface Electrical Included List Price						\$1,546
	SST3066UFING-CB	30	24	66	1 3/16	64	8	\$1,178
	<ul style="list-style-type: none"> · two grommets - left and right corners on approach side · 2 1/4" tall acrylic plenum on ends and approach side · 2" black wire management trough · left and right support options must be specified, see pages 132 and 138 · optional cutout for EC10 and EC11, see page 214 · optional undersurface electrical includes two duplex units 	Undersurface Electrical Included List Price						\$1,521

SWISH

To Order, Specify:

- ① Model number
- ② Worksurface color
- ③ Product Options (see page 76)

② Laminate Color Options:

ALB	Alabaster	GRH	Graphite
AUT	Autumn	HGL	High Line
BLO	Blonde Echo	SHD	Shadow
BBN	Bourbon	SHE	Shea
BZW	Brazilwood	SLG	Slate Grey
BBL	Bridal Blanco	STU	Studio Teak
BRG	Brighton	TAU	Taupe
DWH	Designer White	VIN	Vintage
DOV	Dove Grey	WLH	Walnut Heights

Order Check List

page 76

Product Specifications

page 40

Power and Data Options

page 214

Undersurface Electrical Options

pages 215-217

WORKSURFACE
Fin - Arc User Side
Grommets

Description	① Model	Left D	Right D	W	H	CTN WT	CU FT	List Price
30" Deep 	SST3084UFING-BC	24	30	84	1 3/16	80	10	\$1,406
	<ul style="list-style-type: none"> two grommets - left and right corners on approach side 2 1/4" tall acrylic plenum on ends and approach side 2" black wire management trough left and right support options must be specified, see pages 132 and 138; unsupported span cannot exceed 78", leg to floor for both left and right cannot be specified optional cutout for EC10 and EC11, see page 214 optional undersurface electrical includes two duplex units 							Undersurface Electrical Included List Price \$1,762
	SST3078UFING-BC	24	30	78	1 3/16	75	9	\$1,332
	<ul style="list-style-type: none"> two grommets - left and right corners on approach side 2 1/4" tall acrylic plenum on ends and approach side 2" black wire management trough left and right support options must be specified, see pages 132 and 138 optional cutout for EC10 and EC11, see page 214 optional undersurface electrical includes two duplex units 							Undersurface Electrical Included List Price \$1,685
	SST3072UFING-BC	24	30	72	1 3/16	69	9	\$1,200
	<ul style="list-style-type: none"> two grommets - left and right corners on approach side 2 1/4" tall acrylic plenum on ends and approach side 2" black wire management trough left and right support options must be specified, see pages 132 and 138 optional cutout for EC10 and EC11, see page 214 optional undersurface electrical includes two duplex units 							Undersurface Electrical Included List Price \$1,546
	SST3066UFING-BC	24	30	66	1 3/16	64	8	\$1,178
	<ul style="list-style-type: none"> two grommets - left and right corners on approach side 2 1/4" tall acrylic plenum on ends and approach side 2" black wire management trough left and right support options must be specified, see pages 132 and 138 optional cutout for EC10 and EC11, see page 214 optional undersurface electrical includes two duplex units 							Undersurface Electrical Included List Price \$1,521

SWISH

WORKSURFACE
Fin - Arc User Side
Grommets

Description	① Model	Left D	Right D	W	H	CTN WT	CU FT	List Price
24" Deep 	SST2484UFING-BA	24	18	84	1 3/16	64	8	\$1,322
	<ul style="list-style-type: none"> · two grommets - left and right corners on approach side · 2 1/4" tall acrylic plenum on ends and approach side · 2" black wire management trough · left and right support options must be specified, see pages 132 and 138; · unsupported span cannot exceed 78", leg to floor for both left and right cannot be specified · optional cutout for EC10 and EC11, see page 214 · optional undersurface electrical includes two duplex units 	Undersurface Electrical Included List Price		\$1,678				
	SST2478UFING-BA	24	18	78	1 3/16	60	8	\$1,248
	<ul style="list-style-type: none"> · two grommets - left and right corners on approach side · 2 1/4" tall acrylic plenum on ends and approach side · 2" black wire management trough · left and right support options must be specified, see pages 132 and 138 · optional cutout for EC10 and EC11, see page 214 · optional undersurface electrical includes two duplex units 	Undersurface Electrical Included List Price		\$1,601				
	SST2472UFING-BA	24	18	72	1 3/16	55	7	\$1,088
	<ul style="list-style-type: none"> · two grommets - left and right corners on approach side · 2 1/4" tall acrylic plenum on ends and approach side · 2" black wire management trough · left and right support options must be specified, see pages 132 and 138 · optional cutout for EC10 and EC11, see page 214 · optional undersurface electrical includes two duplex units 	Undersurface Electrical Included List Price		\$1,435				
	SST2466UFING-BA	24	18	66	1 3/16	51	7	\$1,065
	<ul style="list-style-type: none"> · two grommets - left and right corners on approach side · 2 1/4" tall acrylic plenum on ends and approach side · 2" black wire management trough · left and right support options must be specified, see pages 132 and 138 · optional cutout for EC10 and EC11, see page 214 · optional undersurface electrical includes two duplex units 	Undersurface Electrical Included List Price		\$1,409				

SWISH

To Order, Specify:

- ① Model number
- ② Worksurface color
- ③ Product Options (see page 76)

② Laminate Color Options:

ALB Alabaster	GRH Graphite
AUT Autumn	HGL High Line
BLO Blonde Echo	SHD Shadow
BBN Bourbon	SHE Shea
BZW Brazilwood	SLG Slate Grey
BBL Bridal Blanco	STU Studio Teak
BRG Brighton	TAU Taupe
DWH Designer White	VIN Vintage
DOV Dove Grey	WLH Walnut Heights

Order Check List

page 76

Product Specifications

page 40

Power and Data Options

page 214

Undersurface Electrical Options

pages 215-217

WORKSURFACE
Fin - Arc User Side
Grommets

Description	① Model	Left D	Right D	W	H	CTN WT	CU FT	List Price
24" Deep 	SST2484UFING-AB · two grommets - left and right corners on approach side · 2 ¼" tall acrylic plenum on ends and approach side · 2" black wire management trough · left and right support options must be specified, see pages 132 and 138; unsupported span cannot exceed 78", leg to floor for both left and right cannot be specified · optional cutout for EC10 and EC11, see page 214 · optional undersurface electrical includes two duplex units	18	24	84	1 ¾	64	8	\$1,322
								Undersurface Electrical Included List Price \$1,678
	SST2478UFING-AB · two grommets - left and right corners on approach side · 2 ¼" tall acrylic plenum on ends and approach side · 2" black wire management trough · left and right support options must be specified, see pages 132 and 138 · optional cutout for EC10 and EC11, see page 214 · optional undersurface electrical includes two duplex units	18	24	78	1 ¾	60	8	\$1,248
								Undersurface Electrical Included List Price \$1,601
	SST2472UFING-AB · two grommets - left and right corners on approach side · 2 ¼" tall acrylic plenum on ends and approach side · 2" black wire management trough · left and right support options must be specified, see pages 132 and 138 · optional cutout for EC10 and EC11, see page 214 · optional undersurface electrical includes two duplex units	18	24	72	1 ¾	55	7	\$1,088
								Undersurface Electrical Included List Price \$1,435
	SST2466UFING-AB · two grommets - left and right corners on approach side · 2 ¼" tall acrylic plenum on ends and approach side · 2" black wire management trough · left and right support options must be specified, see pages 132 and 138 · optional cutout for EC10 and EC11, see page 214 · optional undersurface electrical includes two duplex units	18	24	66	1 ¾	51	7	\$1,065
								Undersurface Electrical Included List Price \$1,409

SWISH

WORKSURFACE
Fin - Arc Approach Side
Grommets

Description	① Model	Left D	Right D	W	H	CTN WT	CU FT	List Price
36" Deep 	SST3684AFING-DC	36	30	84	1 3/16	96	12	\$1,497
	<ul style="list-style-type: none"> · two grommets - left and right corners on approach side · 2 1/4" tall acrylic plenum on ends and approach side · 2" black wire management trough · left and right support options must be specified, see pages 132 and 138; unsupported span cannot exceed 78", leg to floor for both left and right cannot be specified · when executive height support is specified a 30" deep pedestal must be used · optional cutout for EC10 and EC11, see page 214 · optional undersurface electrical includes two duplex units 	Undersurface Electrical Included List Price						\$1,852
	SST3678AFING-DC	36	30	78	1 3/16	90	11	\$1,433
	<ul style="list-style-type: none"> · two grommets - left and right corners on approach side · 2 1/4" tall acrylic plenum on ends and approach side · 2" black wire management trough · left and right support options must be specified, see pages 132 and 138 · when executive height support is specified a 30" deep pedestal must be used · optional cutout for EC10 and EC11, see page 214 · optional undersurface electrical includes two duplex units 	Undersurface Electrical Included List Price						\$1,785
	SST3672AFING-DC	36	30	72	1 3/16	83	10	\$1,290
	<ul style="list-style-type: none"> · two grommets - left and right corners on approach side · 2 1/4" tall acrylic plenum on ends and approach side · 2" black wire management trough · left and right support options must be specified, see pages 132 and 138 · when executive height support is specified a 30" deep pedestal must be used · optional cutout for EC10 and EC11, see page 214 · optional undersurface electrical includes two duplex units 	Undersurface Electrical Included List Price						\$1,638
	SST3666AFING-DC	36	30	66	1 3/16	76	9	\$1,271
	<ul style="list-style-type: none"> · two grommets - left and right corners on approach side · parallel grain to user side · 2 1/4" tall acrylic plenum on ends and approach side · 2" black wire management trough · left and right support options must be specified, see pages 132 and 138 · when executive height support is specified a 30" deep pedestal must be used · optional cutout for EC10 and EC11, see page 214 · optional undersurface electrical includes two duplex units 	Undersurface Electrical Included List Price						\$1,613

SWISH

To Order, Specify:

- ① Model number
- ② Worksurface color
- ③ Product Options (see page 76)

② Laminate Color Options:

ALB	Alabaster	GRH	Graphite
AUT	Autumn	HGL	High Line
BLO	Blonde Echo	SHD	Shadow
BBN	Bourbon	SHE	Shea
BZW	Brazilwood	SLG	Slate Grey
BBL	Bridal Blanco	STU	Studio Teak
BRG	Brighton	TAU	Taupe
DWH	Designer White	VIN	Vintage
DOV	Dove Grey	WLH	Walnut Heights

Order Check List

page 76

Product Specifications

page 40

Power and Data Options

page 214

Undersurface Electrical Options

pages 215-217

WORKSURFACE
Fin - Arc Approach Side
Grommets

Description	① Model	Left D	Right D	W	H	CTN WT	CU FT	List Price	
36" Deep 	SST3684AFING-CD	30	36	84	1 3/16	96	12	\$1,497	
	<ul style="list-style-type: none"> two grommets - left and right corners on approach side 2 1/4" tall acrylic plenum on ends and approach side 2" black wire management trough left and right support options must be specified, see pages 132 and 138; unsupported span cannot exceed 78", leg to floor for both left and right cannot be specified when executive height support is specified a 30" deep pedestal must be used optional cutout for EC10 and EC11, see page 214 optional undersurface electrical includes two duplex units 								Undersurface Electrical Included List Price \$1,852
	SST3678AFING-CD	30	36	78	1 3/16	90	11	\$1,433	
	<ul style="list-style-type: none"> two grommets - left and right corners on approach side 2 1/4" tall acrylic plenum on ends and approach side 2" black wire management trough left and right support options must be specified, see pages 132 and 138 when executive height support is specified a 30" deep pedestal must be used optional cutout for EC10 and EC11, see page 214 optional undersurface electrical includes two duplex units 								Undersurface Electrical Included List Price \$1,785
	SST3672AFING-CD	30	36	72	1 3/16	83	10	\$1,290	
	<ul style="list-style-type: none"> two grommets - left and right corners on approach side 2 1/4" tall acrylic plenum on ends and approach side 2" black wire management trough left and right support options must be specified, see pages 132 and 138 when executive height support is specified a 30" deep pedestal must be used optional cutout for EC10 and EC11, see page 214 optional undersurface electrical includes two duplex units 								Undersurface Electrical Included List Price \$1,638
	SST3666AFING-CD	30	36	66	1 3/16	76	9	\$1,271	
	<ul style="list-style-type: none"> two grommets - left and right corners on approach side 2 1/4" tall acrylic plenum on ends and approach side 2" black wire management trough left and right support options must be specified, see pages 132 and 138 when executive height support is specified a 30" deep pedestal must be used optional cutout for EC10 and EC11, see page 214 optional undersurface electrical includes two duplex units 								Undersurface Electrical Included List Price \$1,613

SWISH

WORKSURFACE
Fin - Arc Approach Side
Grommets

Description	1 Model	Left D	Right D	W	H	CTN WT	CU FT	List Price
30" Deep 	SST3084AFING-CB	30	24	84	1 3/16	80	10	\$1,403
	<ul style="list-style-type: none"> · two grommets - left and right corners on approach side · 2 1/4" tall acrylic plenum on ends and approach side · 2" black wire management trough · left and right support options must be specified, see pages 132 and 138; unsupported span cannot exceed 78", leg to floor for both left and right cannot be specified · when executive height support is specified a 24" deep pedestal must be used · optional cutout for EC10 and EC11, see page 214 · optional undersurface electrical includes two duplex units 	Undersurface Electrical Included List Price		\$1,759				
	SST3078AFING-CB	30	24	78	1 3/16	75	9	\$1,329
	<ul style="list-style-type: none"> · two grommets - left and right corners on approach side · 2 1/4" tall acrylic plenum on ends and approach side · 2" black wire management trough · left and right support options must be specified, see pages 132 and 138 · when executive height support is specified a 24" deep pedestal must be used · optional cutout for EC10 and EC11, see page 214 · optional undersurface electrical includes two duplex units 	Undersurface Electrical Included List Price		\$1,682				
	SST3072AFING-CB	30	24	72	1 3/16	69	9	\$1,197
	<ul style="list-style-type: none"> · two grommets - left and right corners on approach side · 2 1/4" tall acrylic plenum on ends and approach side · 2" black wire management trough · left and right support options must be specified, see pages 132 and 138 · when executive height support is specified a 24" deep pedestal must be used · optional cutout for EC10 and EC11, see page 214 · optional undersurface electrical includes two duplex units 	Undersurface Electrical Included List Price		\$1,544				
	SST3066AFING-CB	30	24	66	1 3/16	64	8	\$1,174
	<ul style="list-style-type: none"> · two grommets - left and right corners on approach side · 2 1/4" tall acrylic plenum on ends and approach side · 2" black wire management trough · left and right support options must be specified, see pages 132 and 138 · when executive height support is specified a 24" deep pedestal must be used · optional cutout for EC10 and EC11, see page 214 · optional undersurface electrical includes two duplex units 	Undersurface Electrical Included List Price		\$1,518				

SWISH

To Order, Specify:

- 1 Model number
- 2 Worksurface color
- 3 Product Options (see page 76)

2 Laminate Color Options:

ALB Alabaster	GRH Graphite
AUT Autumn	HGL High Line
BLO Blonde Echo	SHD Shadow
BBN Bourbon	SHE Shea
BZW Brazilwood	SLG Slate Grey
BBL Bridal Blanco	STU Studio Teak
BRG Brighton	TAU Taupe
DWH Designer White	VIN Vintage
DOV Dove Grey	WLH Walnut Heights

Order Check List

page 76

Product Specifications

page 40

Power and Data Options

page 214

Undersurface Electrical Options

pages 215-217

WORKSURFACE
Fin - Arc Approach Side
Grommets

Description	① Model	Left D	Right D	W	H	CTN WT	CU FT	List Price
30" Deep 	SST3084AFING-BC	24	30	84	1 3/16	80	10	\$1,403
	<ul style="list-style-type: none"> · two grommets - left and right corners on approach side · 2 1/4" tall acrylic plenum on ends and approach side · 2" black wire management trough · left and right support options must be specified, see pages 132 and 138; unsupported span cannot exceed 78", leg to floor for both left and right cannot be specified · when executive height support is specified a 24" deep pedestal must be used · optional cutout for EC10 and EC11, see page 214 · optional undersurface electrical includes two duplex units 	Undersurface Electrical Included List Price		\$1,759				
	SST3078AFING-BC	24	30	78	1 3/16	75	9	\$1,329
	<ul style="list-style-type: none"> · two grommets - left and right corners on approach side · 2 1/4" tall acrylic plenum on ends and approach side · 2" black wire management trough · left and right support options must be specified, see pages 132 and 138 · when executive height support is specified a 24" deep pedestal must be used · optional cutout for EC10 and EC11, see page 214 · optional undersurface electrical includes two duplex units 	Undersurface Electrical Included List Price		\$1,682				
	SST3072AFING-BC	24	30	72	1 3/16	69	9	\$1,197
	<ul style="list-style-type: none"> · two grommets - left and right corners on approach side · 2 1/4" tall acrylic plenum on ends and approach side · 2" black wire management trough · left and right support options must be specified, see pages 132 and 138 · when executive height support is specified a 24" deep pedestal must be used · optional cutout for EC10 and EC11, see page 214 · optional undersurface electrical includes two duplex units 	Undersurface Electrical Included List Price		\$1,544				
	SST3066AFING-BC	24	30	66	1 3/16	64	8	\$1,174
	<ul style="list-style-type: none"> · two grommets - left and right corners on approach side · 2 1/4" tall acrylic plenum on ends and approach side · 2" black wire management trough · left and right support options must be specified, see pages 132 and 138 · when executive height support is specified a 24" deep pedestal must be used · optional cutout for EC10 and EC11, see page 214 · optional undersurface electrical includes two duplex units 	Undersurface Electrical Included List Price		\$1,518				

SWISH

WORKSURFACE
Fin - Arc Approach Side
Grommets

Description	① Model	Left D	Right D	W	H	CTN WT	CU FT	List Price	
24" Deep 	SST2484AFING-BA · two grommets - left and right corners on approach side · 2 1/4" tall acrylic plenum on ends and approach side · 2" black wire management trough · left and right support options must be specified, see pages 132 and 138; unsupported span cannot exceed 78", leg to floor for both left and right cannot be specified · when executive height support is specified an 18" deep pedestal must be used · optional cutout for EC10 and EC11, see page 214 · optional undersurface electrical includes two duplex units	24	18	84	1 3/16	64	8	\$1,319	
		Undersurface Electrical Included List Price							
	SST2478AFING-BA · two grommets - left and right corners on approach side · 2 1/4" tall acrylic plenum on ends and approach side · 2" black wire management trough · left and right support options must be specified, see pages 132 and 138 · when executive height support is specified an 18" deep pedestal must be used · optional cutout for EC10 and EC11, see page 214 · optional undersurface electrical includes two duplex units	24	18	78	1 3/16	60	8	\$1,246	
		Undersurface Electrical Included List Price							
	SST2472AFING-BA · two grommets - left and right corners on approach side · 2 1/4" tall acrylic plenum on ends and approach side · 2" black wire management trough · left and right support options must be specified, see pages 132 and 138 · when executive height support is specified an 18" deep pedestal must be used · optional cutout for EC10 and EC11, see page 214 · optional undersurface electrical includes two duplex units	24	18	72	1 3/16	55	7	\$1,085	
		Undersurface Electrical Included List Price							
	SST2466AFING-BA · two grommets - left and right corners on approach side · 2 1/4" tall acrylic plenum on ends and approach side · 2" black wire management trough · left and right support options must be specified, see pages 132 and 138 · when executive height support is specified an 18" deep pedestal must be used · optional cutout for EC10 and EC11, see page 214 · optional undersurface electrical includes two duplex units	24	18	66	1 3/16	51	7	\$1,063	
		Undersurface Electrical Included List Price							

SWISH

To Order, Specify:

- ① Model number
- ② Worksurface color
- ③ Product Options (see page 76)

② Laminate Color Options:

ALB Alabaster	GRH Graphite
AUT Autumn	HGL High Line
BLO Blonde Echo	SHD Shadow
BBN Bourbon	SHE Shea
BZW Brazilwood	SLG Slate Grey
BBL Bridal Blanco	STU Studio Teak
BRG Brighton	TAU Taupe
DWH Designer White	VIN Vintage
DOV Dove Grey	WLH Walnut Heights

Order Check List

page 76

Product Specifications

page 40

Power and Data Options

page 214

Undersurface Electrical Options

pages 215-217

WORKSURFACE
Fin - Arc Approach Side
Grommets

Description	① Model	Left D	Right D	W	H	CTN WT	CU FT	List Price	
24" Deep 	SST2484AFING-AB	18	24	84	1 3/16	64	8	\$1,319	
	<ul style="list-style-type: none"> · two grommets - left and right corners on approach side · 2 1/4" tall acrylic plenum on ends and approach side · 2" black wire management trough · left and right support options must be specified, see pages 132 and 138; unsupported span cannot exceed 78", leg to floor for both left and right cannot be specified · when executive height support is specified an 18" deep pedestal must be used · optional cutout for EC10 and EC11, see page 214 · optional undersurface electrical includes two duplex units 								Undersurface Electrical Included List Price \$1,675
	SST2478AFING-AB	18	24	78	1 3/16	60	8	\$1,246	
	<ul style="list-style-type: none"> · two grommets - left and right corners on approach side · 2 1/4" tall acrylic plenum on ends and approach side · 2" black wire management trough · left and right support options must be specified, see pages 132 and 138 · when executive height support is specified an 18" deep pedestal must be used · optional cutout for EC10 and EC11, see page 214 · optional undersurface electrical includes two duplex units 								Undersurface Electrical Included List Price \$1,598
	SST2472AFING-AB	18	24	72	1 3/16	55	7	\$1,085	
	<ul style="list-style-type: none"> · two grommets - left and right corners on approach side · 2 1/4" tall acrylic plenum on ends and approach side · 2" black wire management trough · left and right support options must be specified, see pages 132 and 138 · when executive height support is specified an 18" deep pedestal must be used · optional cutout for EC10 and EC11, see page 214 · optional undersurface electrical includes two duplex units 								Undersurface Electrical Included List Price \$1,432
	SST2466AFING-AB	18	24	66	1 3/16	51	7	\$1,063	
	<ul style="list-style-type: none"> · two grommets - left and right corners on approach side · 2 1/4" tall acrylic plenum on ends and approach side · 2" black wire management trough · left and right support options must be specified, see pages 132 and 138 · when executive height support is specified an 18" deep pedestal must be used · optional cutout for EC10 and EC11, see page 214 · optional undersurface electrical includes two duplex units 								Undersurface Electrical Included List Price \$1,405

SWISH

WORKSURFACE
Corner
Grommets

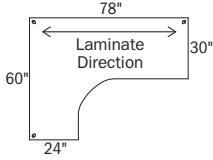
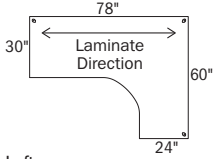
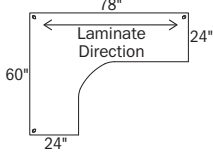
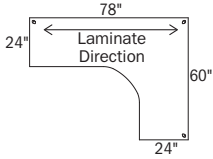
	Description	① Model	D	W	H	CTN WT	CU FT	List Price
 <p>Right</p>	<p>Corner Worksurface</p> <ul style="list-style-type: none"> · three grommets - left, center and right corners on approach side · 2 1/4" tall acrylic plenum on ends and approach side · 2" black wire management trough · left, center and right support options must be specified, see pages 132 and 138 · center support options include a single leg to floor, single leg to bench height or single spacer to executive height · pedestal restrictions apply, refer to page 76 · optional cutout for EC10 and EC11, see page 214 · optional undersurface electrical includes two duplex units 	Right SST6078CRNRG-BC-R	60	78	1 3/16	104	18	\$1,923
		Left SST6078CRNRG-CB-L	60	78	1 3/16	104	18	\$1,923
Undersurface Electrical Included List Price \$2,431								
 <p>Left</p>	<p>Corner Worksurface</p> <ul style="list-style-type: none"> · three grommets - left, center and right corners on approach side · 2 1/4" tall acrylic plenum on ends and approach side · 2" black wire management trough · left, center and right support options must be specified, see pages 132 and 138 · center support options include a single leg to floor, single leg to bench height or single spacer to executive height · pedestal restrictions apply, refer to page 76 · optional cutout for EC10 and EC11, see page 214 · optional undersurface electrical includes two duplex units 	Right SST6078CRNRG-BB-R	60	78	1 3/16	96	18	\$1,920
		Left SST6078CRNRG-BB-L	60	78	1 3/16	96	18	\$1,920
Undersurface Electrical Included List Price \$2,428								
 <p>Right</p>	<p>Corner Worksurface</p> <ul style="list-style-type: none"> · three grommets - left, center and right corners on approach side · 2 1/4" tall acrylic plenum on ends and approach side · 2" black wire management trough · left, center and right support options must be specified, see pages 132 and 138 · center support options include a single leg to floor, single leg to bench height or single spacer to executive height · pedestal restrictions apply, refer to page 76 · optional cutout for EC10 and EC11, see page 214 · optional undersurface electrical includes two duplex units 	Right SST6078CRNRG-BB-R	60	78	1 3/16	96	18	\$1,920
		Left SST6078CRNRG-BB-L	60	78	1 3/16	96	18	\$1,920
Undersurface Electrical Included List Price \$2,428								
 <p>Left</p>	<p>Corner Worksurface</p> <ul style="list-style-type: none"> · three grommets - left, center and right corners on approach side · 2 1/4" tall acrylic plenum on ends and approach side · 2" black wire management trough · left, center and right support options must be specified, see pages 132 and 138 · center support options include a single leg to floor, single leg to bench height or single spacer to executive height · pedestal restrictions apply, refer to page 76 · optional cutout for EC10 and EC11, see page 214 · optional undersurface electrical includes two duplex units 	Right SST6078CRNRG-BB-R	60	78	1 3/16	96	18	\$1,920
		Left SST6078CRNRG-BB-L	60	78	1 3/16	96	18	\$1,920
Undersurface Electrical Included List Price \$2,428								

SWISH

To Order, Specify:

- ① Model number
- ② Worksurface color
- ③ Product Options (see page 76)

② Laminate Color Options:

ALB Alabaster	GRH Graphite
AUT Autumn	HGL High Line
BLO Blonde Echo	SHD Shadow
BBN Bourbon	SHE Shea
BZW Brazilwood	SLG Slate Grey
BBL Bridal Blanco	STU Studio Teak
BRG Brighton	TAU Taupe
DWH Designer White	VIN Vintage
DOV Dove Grey	WLH Walnut Heights

Order Check List

page 76

Product Specifications

page 40

Power and Data Options

page 214

Undersurface Electrical Options

pages 215-217

WORKSURFACE

Corner Grommets

SWISH

	Description	Model	D	W	H	CTN WT	CU FT	List Price
<p>Right</p>	<p>Corner Worksurface</p> <ul style="list-style-type: none"> · three grommets - left, center and right corners on approach side · 2 1/4" tall acrylic plenum on ends and approach side · 2" black wire management trough · left, center and right support options must be specified, see pages 132 and 138 · center support options include a single leg to floor, single leg to bench height or single spacer to executive height · pedestal restrictions apply, refer to page 76 · optional cutout for EC10 and EC11, see page 214 · optional undersurface electrical includes two duplex units 	Right SST6072CRNRG-BC-R	60	72	1 3/16	97	16	\$1,843
		Left SST6072CRNRG-CB-L	60	72	1 3/16	97	16	\$1,843
		Undersurface Electrical Included List Price \$2,347						
<p>Right</p>	<p>Corner Worksurface</p> <ul style="list-style-type: none"> · three grommets - left, center and right corners on approach side · 2 1/4" tall acrylic plenum on ends and approach side · 2" black wire management trough · left, center and right support options must be specified, see pages 132 and 138 · center support options include a single leg to floor, single leg to bench height or single spacer to executive height · pedestal restrictions apply, refer to page 76 · optional cutout for EC10 and EC11, see page 214 · optional undersurface electrical includes two duplex units 	Right SST6072CRNRG-BB-R	60	72	1 3/16	90	16	\$1,839
		Left SST6072CRNRG-BB-L	60	72	1 3/16	90	16	\$1,839
		Undersurface Electrical Included List Price \$2,343						
<p>Right</p>	<p>Corner Worksurface</p> <ul style="list-style-type: none"> · three grommets - left, center and right corners on approach side · 2 1/4" tall acrylic plenum on ends and approach side · 2" black wire management trough · left, center and right support options must be specified, see pages 132 and 138 · center support options include a single leg to floor, single leg to bench height or single spacer to executive height · pedestal restrictions apply, refer to page 76 · optional cutout for EC10 and EC11, see page 214 · optional undersurface electrical includes two duplex units 	Right SST6072CRNRG-AC-R	60	72	1 3/16	93	16	\$1,839
		Left SST6072CRNRG-CA-L	60	72	1 3/16	93	16	\$1,839
		Undersurface Electrical Included List Price \$2,343						
<p>Right</p>	<p>Corner Worksurface</p> <ul style="list-style-type: none"> · three grommets - left, center and right corners on approach side · 2 1/4" tall acrylic plenum on ends and approach side · 2" black wire management trough · left, center and right support options must be specified, see pages 132 and 138 · center support options include a single leg to floor, single leg to bench height or single spacer to executive height · pedestal restrictions apply, refer to page 76 · optional cutout for EC10 and EC11, see page 214 · optional undersurface electrical includes two duplex units 	Right SST6072CRNRG-AB-R	60	72	1 3/16	85	16	\$1,837
		Left SST6072CRNRG-BA-L	60	72	1 3/16	85	16	\$1,837
		Undersurface Electrical Included List Price \$2,340						
<p>Right</p>	<p>Corner Worksurface</p> <ul style="list-style-type: none"> · three grommets - left, center and right corners on approach side · 2 1/4" tall acrylic plenum on ends and approach side · 2" black wire management trough · left, center and right support options must be specified, see pages 132 and 138 · center support options include a single leg to floor, single leg to bench height or single spacer to executive height · pedestal restrictions apply, refer to page 76 · optional cutout for EC10 and EC11, see page 214 · optional undersurface electrical includes two duplex units 	Right SST6072CRNRG-AB-R	60	72	1 3/16	85	16	\$1,837
		Left SST6072CRNRG-BA-L	60	72	1 3/16	85	16	\$1,837
		Undersurface Electrical Included List Price \$2,340						

WORKSURFACE
Corner
Grommets

	Description	① Model	D	W	H	CTN WT	CU FT	List Price
<p>Right</p>	<p>Corner Worksurface</p> <ul style="list-style-type: none"> · three grommets - left, center and right corners on approach side · 2 1/4" tall acrylic plenum on ends and approach side · 2" black wire management trough · left, center and right support options must be specified, see pages 132 and 138 · center support options include a single leg to floor, single leg to bench height or single spacer to executive height · pedestal restrictions apply, refer to page 76 · optional cutout for EC10 and EC11, see page 214 · optional undersurface electrical includes two duplex units 	Right SST6066CRNRG-BC-R	60	66	1 3/16	91	15	\$1,819
		Left SST6066CRNRG-CB-L	60	66	1 3/16	91	15	\$1,819
Undersurface Electrical Included List Price \$2,319								
<p>Left</p>	<p>Corner Worksurface</p> <ul style="list-style-type: none"> · three grommets - left, center and right corners on approach side · 2 1/4" tall acrylic plenum on ends and approach side · 2" black wire management trough · left, center and right support options must be specified, see pages 132 and 138 · center support options include a single leg to floor, single leg to bench height or single spacer to executive height · pedestal restrictions apply, refer to page 76 · optional cutout for EC10 and EC11, see page 214 · optional undersurface electrical includes two duplex units 	Right SST6066CRNRG-BB-R	60	66	1 3/16	84	15	\$1,816
		Left SST6066CRNRG-BB-L	60	66	1 3/16	84	15	\$1,816
Undersurface Electrical Included List Price \$2,316								
<p>Right</p>	<p>Corner Worksurface</p> <ul style="list-style-type: none"> · three grommets - left, center and right corners on approach side · 2 1/4" tall acrylic plenum on ends and approach side · 2" black wire management trough · left, center and right support options must be specified, see pages 132 and 138 · center support options include a single leg to floor, single leg to bench height or single spacer to executive height · pedestal restrictions apply, refer to page 76 · optional cutout for EC10 and EC11, see page 214 · optional undersurface electrical includes two duplex units 	Right SST6066CRNRG-AC-R	60	66	1 3/16	86	15	\$1,816
		Left SST6066CRNRG-CA-L	60	66	1 3/16	86	15	\$1,816
Undersurface Electrical Included List Price \$2,316								
<p>Left</p>	<p>Corner Worksurface</p> <ul style="list-style-type: none"> · three grommets - left, center and right corners on approach side · 2 1/4" tall acrylic plenum on ends and approach side · 2" black wire management trough · left, center and right support options must be specified, see pages 132 and 138 · center support options include a single leg to floor, single leg to bench height or single spacer to executive height · pedestal restrictions apply, refer to page 76 · optional cutout for EC10 and EC11, see page 214 · optional undersurface electrical includes two duplex units 	Right SST6066CRNRG-AC-R	60	66	1 3/16	86	15	\$1,816
		Left SST6066CRNRG-CA-L	60	66	1 3/16	86	15	\$1,816
Undersurface Electrical Included List Price \$2,316								

To Order, Specify:

- ① Model number
- ② Worksurface color
- ③ Product Options (see page 76)

② Laminate Color Options:

ALB Alabaster	GRH Graphite
AUT Autumn	HGL High Line
BLO Blonde Echo	SHD Shadow
BBN Bourbon	SHE Shea
BZW Brazilwood	SLG Slate Grey
BBL Bridal Blanco	STU Studio Teak
BRG Brighton	TAU Taupe
DWH Designer White	VIN Vintage
DOV Dove Grey	WLH Walnut Heights

Order Check List
page 76

Product Specifications
page 40

Power and Data Options
page 214

Undersurface Electrical Options
pages 215-217

WORKSURFACE

Corner
Grommets

SWISH

	Description	Model	D	W	H	CTN WT	CU FT	List Price
<p>Right</p>	<p>Corner Worksurface</p> <ul style="list-style-type: none"> · three grommets - left, center and right corners on approach side · 2 1/4" tall acrylic plenum on ends and approach side · 2" black wire management trough · left, center and right support options must be specified, see pages 132 and 138 · center support options include a single leg to floor, single leg to bench height or single spacer to executive height · pedestal restrictions apply, refer to page 76 · optional cutout for EC10 and EC11, see page 214 · optional undersurface electrical includes two duplex units 	Right SST6066CRNRG-AB-R	60	66	1 3/16	79	15	\$1,814
		Left SST6066CRNRG-BA-L	60	66	1 3/16	79	15	\$1,814
Undersurface Electrical Included List Price								\$2,314
<p>Right</p>	<p>Corner Worksurface</p> <ul style="list-style-type: none"> · three grommets - left, center and right corners on approach side · 2 1/4" tall acrylic plenum on ends and approach side · 2" black wire management trough · left, center and right support options must be specified, see pages 132 and 138 · center support options include a single leg to floor, single leg to bench height or single spacer to executive height · pedestal restrictions apply, refer to page 76 · optional cutout for EC10 and EC11, see page 214 · optional undersurface electrical includes two duplex units 	Right SST6060CRNRG-BC-R	60	60	1 3/16	84	14	\$1,740
		Left SST6060CRNRG-CB-L	60	60	1 3/16	84	14	\$1,740
Undersurface Electrical Included List Price								\$2,235
<p>Right</p>	<p>Corner Worksurface</p> <ul style="list-style-type: none"> · three grommets - left, center and right corners on approach side · 2 1/4" tall acrylic plenum on ends and approach side · 2" black wire management trough · left, center and right support options must be specified, see pages 132 and 138 · center support options include a single leg to floor, single leg to bench height or single spacer to executive height · pedestal restrictions apply, refer to page 76 · optional cutout for EC10 and EC11, see page 214 · optional undersurface electrical includes two duplex units 	Right SST6060CRNRG-BB-R	60	60	1 3/16	79	14	\$1,738
		Left SST6060CRNRG-BB-L	60	60	1 3/16	79	14	\$1,738
Undersurface Electrical Included List Price								\$2,233
<p>Right</p>	<p>Corner Worksurface</p> <ul style="list-style-type: none"> · three grommets - left, center and right corners on approach side · 2 1/4" tall acrylic plenum on ends and approach side · 2" black wire management trough · left, center and right support options must be specified, see pages 132 and 138 · center support options include a single leg to floor, single leg to bench height or single spacer to executive height · pedestal restrictions apply, refer to page 76 · optional cutout for EC10 and EC11, see page 214 · optional undersurface electrical includes two duplex units 	Right SST6060CRNRG-AC-R	60	60	1 3/16	80	14	\$1,738
		Left SST6060CRNRG-CA-L	60	60	1 3/16	80	14	\$1,738
Undersurface Electrical Included List Price								\$2,233

WORKSURFACE
Corner
Grommets

	Description	① Model	D	W	H	CTN WT	CU FT	List Price
<p>Right</p>	<p>Corner Worksurface</p> <ul style="list-style-type: none"> • three grommets - left, center and right corners on approach side • 2 1/4" tall acrylic plenum on ends and approach side • 2" black wire management trough • left, center and right support options must be specified, see pages 132 and 138 • center support options include a single leg to floor, single leg to bench height or single spacer to executive height • pedestal restrictions apply, refer to page 76 • optional cutout for EC10 and EC11, see page 214 • optional undersurface electrical includes two duplex units 	Right SST6060CRNRG-AB-R	60	60	1 3/16	73	14	\$1,735
		Left SST6060CRNRG-BA-L	60	60	1 3/16	73	14	\$1,735
Undersurface Electrical Included List Price \$2,229								
<p>Left</p>	<p>Corner Worksurface</p> <ul style="list-style-type: none"> • three grommets - left, center and right corners on approach side • 2 1/4" tall acrylic plenum on ends and approach side • 2" black wire management trough • left, center and right support options must be specified, see pages 132 and 138 • center support options include a single leg to floor, single leg to bench height or single spacer to executive height • pedestal restrictions apply, refer to page 76 • optional cutout for EC10 and EC11, see page 214 • optional undersurface electrical includes two duplex units 	Right SST5478CRNRG-BC-R	54	78	1 3/16	97	16	\$1,908
		Left SST5478CRNRG-CB-L	54	78	1 3/16	97	16	\$1,908
Undersurface Electrical Included List Price \$2,411								
<p>Right</p>	<p>Corner Worksurface</p> <ul style="list-style-type: none"> • three grommets - left, center and right corners on approach side • 2 1/4" tall acrylic plenum on ends and approach side • 2" black wire management trough • left, center and right support options must be specified, see pages 132 and 138 • center support options include a single leg to floor, single leg to bench height or single spacer to executive height • pedestal restrictions apply, refer to page 76 • optional cutout for EC10 and EC11, see page 214 • optional undersurface electrical includes two duplex units 	Right SST5478CRNRG-BB-R	54	78	1 3/16	90	16	\$1,905
		Left SST5478CRNRG-BB-L	54	78	1 3/16	90	16	\$1,905
Undersurface Electrical Included List Price \$2,408								
<p>Left</p>	<p>Corner Worksurface</p> <ul style="list-style-type: none"> • three grommets - left, center and right corners on approach side • 2 1/4" tall acrylic plenum on ends and approach side • 2" black wire management trough • left, center and right support options must be specified, see pages 132 and 138 • center support options include a single leg to floor, single leg to bench height or single spacer to executive height • pedestal restrictions apply, refer to page 76 • optional cutout for EC10 and EC11, see page 214 • optional undersurface electrical includes two duplex units 	Right SST5478CRNRG-BC-R	54	78	1 3/16	90	16	\$1,905
		Left SST5478CRNRG-CB-L	54	78	1 3/16	90	16	\$1,905
Undersurface Electrical Included List Price \$2,408								

To Order, Specify:

- ① Model number
- ② Worksurface color
- ③ Product Options (see page 76)

② Laminate Color Options:

ALB	Alabaster	GRH	Graphite
AUT	Autumn	HGL	High Line
BLO	Blonde Echo	SHD	Shadow
BBN	Bourbon	SHE	Shea
BZW	Brazilwood	SLG	Slate Grey
BBL	Bridal Blanco	STU	Studio Teak
BRG	Brighton	TAU	Taupe
DWH	Designer White	VIN	Vintage
DOV	Dove Grey	WLH	Walnut Heights

Order Check List
page 76

Product Specifications
page 40

Power and Data Options
page 214

Undersurface Electrical Options
pages 215-217

WORKSURFACE

Corner
Grommets

SWISH

	Description	Model	D	W	H	CTN WT	CU FT	List Price
<p>Right</p>	<p>Corner Worksurface</p> <ul style="list-style-type: none"> · three grommets - left, center and right corners on approach side · 2 1/4" tall acrylic plenum on ends and approach side · 2" black wire management trough · left, center and right support options must be specified, see pages 132 and 138 · center support options include a single leg to floor, single leg to bench height or single spacer to executive height · pedestal restrictions apply, refer to page 76 · optional cutout for EC10 and EC11, see page 214 · optional undersurface electrical includes two duplex units 	Right SST5472CRNRG-BC-R	54	72	1 3/16	91	15	\$1,841
		Left SST5472CRNRG-CB-L	54	72	1 3/16	91	15	\$1,841
		Undersurface Electrical Included List Price \$2,339						
<p>Left</p>	<p>Corner Worksurface</p> <ul style="list-style-type: none"> · three grommets - left, center and right corners on approach side · 2 1/4" tall acrylic plenum on ends and approach side · 2" black wire management trough · left, center and right support options must be specified, see pages 132 and 138 · center support options include a single leg to floor, single leg to bench height or single spacer to executive height · pedestal restrictions apply, refer to page 76 · optional cutout for EC10 and EC11, see page 214 · optional undersurface electrical includes two duplex units 	Right SST5472CRNRG-BB-R	54	72	1 3/16	84	15	\$1,837
		Left SST5472CRNRG-BB-L	54	72	1 3/16	84	15	\$1,837
		Undersurface Electrical Included List Price \$2,336						
<p>Right</p>	<p>Corner Worksurface</p> <ul style="list-style-type: none"> · three grommets - left, center and right corners on approach side · 2 1/4" tall acrylic plenum on ends and approach side · 2" black wire management trough · left, center and right support options must be specified, see pages 132 and 138 · center support options include a single leg to floor, single leg to bench height or single spacer to executive height · pedestal restrictions apply, refer to page 76 · optional cutout for EC10 and EC11, see page 214 · optional undersurface electrical includes two duplex units 	Right SST5472CRNRG-AB-R	54	72	1 3/16	80	15	\$1,834
		Left SST5472CRNRG-BA-L	54	72	1 3/16	80	15	\$1,834
		Undersurface Electrical Included List Price \$2,333						
<p>Left</p>	<p>Corner Worksurface</p> <ul style="list-style-type: none"> · three grommets - left, center and right corners on approach side · 2 1/4" tall acrylic plenum on ends and approach side · 2" black wire management trough · left, center and right support options must be specified, see pages 132 and 138 · center support options include a single leg to floor, single leg to bench height or single spacer to executive height · pedestal restrictions apply, refer to page 76 · optional cutout for EC10 and EC11, see page 214 · optional undersurface electrical includes two duplex units 	Right SST5472CRNRG-AB-R	54	72	1 3/16	80	15	\$1,834
		Left SST5472CRNRG-BA-L	54	72	1 3/16	80	15	\$1,834
		Undersurface Electrical Included List Price \$2,333						
<p>Right</p>	<p>Corner Worksurface</p> <ul style="list-style-type: none"> · three grommets - left, center and right corners on approach side · 2 1/4" tall acrylic plenum on ends and approach side · 2" black wire management trough · left, center and right support options must be specified, see pages 132 and 138 · center support options include a single leg to floor, single leg to bench height or single spacer to executive height · pedestal restrictions apply, refer to page 76 · optional cutout for EC10 and EC11, see page 214 · optional undersurface electrical includes two duplex units 	Right SST5466CRNRG-BC-R	54	66	1 3/16	85	14	\$1,817
		Left SST5466CRNRG-CB-L	54	66	1 3/16	85	14	\$1,817
		Undersurface Electrical Included List Price \$2,313						
<p>Left</p>	<p>Corner Worksurface</p> <ul style="list-style-type: none"> · three grommets - left, center and right corners on approach side · 2 1/4" tall acrylic plenum on ends and approach side · 2" black wire management trough · left, center and right support options must be specified, see pages 132 and 138 · center support options include a single leg to floor, single leg to bench height or single spacer to executive height · pedestal restrictions apply, refer to page 76 · optional cutout for EC10 and EC11, see page 214 · optional undersurface electrical includes two duplex units 	Right SST5466CRNRG-BC-R	54	66	1 3/16	85	14	\$1,817
		Left SST5466CRNRG-CB-L	54	66	1 3/16	85	14	\$1,817
		Undersurface Electrical Included List Price \$2,313						

WORKSURFACE
Corner
Grommets

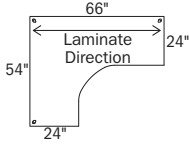
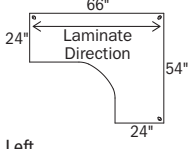
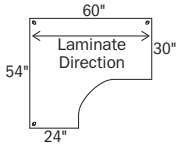
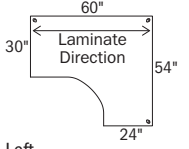
	Description	① Model	D	W	H	CTN WT	CU FT	List Price	
 <p>Right</p>	<p>Corner Worksurface</p> <ul style="list-style-type: none"> · three grommets - left, center and right corners on approach side · 2 1/4" tall acrylic plenum on ends and approach side · 2" black wire management trough · left, center and right support options must be specified, see pages 132 and 138 · center support options include a single leg to floor, single leg to bench height or single spacer to executive height · pedestal restrictions apply, refer to page 76 · optional cutout for EC10 and EC11, see page 214 · optional undersurface electrical includes two duplex units 	Right	SST5466CRNRG-BB-R	54	66	1 3/16	79	14	\$1,814
		Left	SST5466CRNRG-BB-L	54	66	1 3/16	79	14	\$1,814
Undersurface Electrical Included List Price \$2,309									
 <p>Left</p>	<p>Corner Worksurface</p> <ul style="list-style-type: none"> · three grommets - left, center and right corners on approach side · 2 1/4" tall acrylic plenum on ends and approach side · 2" black wire management trough · left, center and right support options must be specified, see pages 132 and 138 · center support options include a single leg to floor, single leg to bench height or single spacer to executive height · pedestal restrictions apply, refer to page 76 · optional cutout for EC10 and EC11, see page 214 · optional undersurface electrical includes two duplex units 	Right	SST5460CRNRG-BC-R	54	60	1 3/16	78	13	\$1,738
		Left	SST5460CRNRG-CB-L	54	60	1 3/16	78	13	\$1,738
Undersurface Electrical Included List Price \$2,233									
 <p>Right</p>	<p>Corner Worksurface</p> <ul style="list-style-type: none"> · three grommets - left, center and right corners on approach side · 2 1/4" tall acrylic plenum on ends and approach side · 2" black wire management trough · left, center and right support options must be specified, see pages 132 and 138 · center support options include a single leg to floor, single leg to bench height or single spacer to executive height · pedestal restrictions apply, refer to page 76 · optional cutout for EC10 and EC11, see page 214 · optional undersurface electrical includes two duplex units 	Right	SST5460CRNRG-BB-R	54	60	1 3/16	73	13	\$1,735
		Left	SST5460CRNRG-BB-L	54	60	1 3/16	73	13	\$1,735
Undersurface Electrical Included List Price \$2,229									
 <p>Left</p>	<p>Corner Worksurface</p> <ul style="list-style-type: none"> · three grommets - left, center and right corners on approach side · 2 1/4" tall acrylic plenum on ends and approach side · 2" black wire management trough · left, center and right support options must be specified, see pages 132 and 138 · center support options include a single leg to floor, single leg to bench height or single spacer to executive height · pedestal restrictions apply, refer to page 76 · optional cutout for EC10 and EC11, see page 214 · optional undersurface electrical includes two duplex units 	Right	SST5460CRNRG-BC-R	54	60	1 3/16	78	13	\$1,738
		Left	SST5460CRNRG-CB-L	54	60	1 3/16	78	13	\$1,738

SWISH

To Order, Specify:

- ① Model number
- ② Worksurface color
- ③ Product Options (see page 76)

② Laminate Color Options:

ALB	Alabaster	GRH	Graphite
AUT	Autumn	HGL	High Line
BLO	Blonde Echo	SHD	Shadow
BBN	Bourbon	SHE	Shea
BZW	Brazilwood	SLG	Slate Grey
BBL	Bridal Blanco	STU	Studio Teak
BRG	Brighton	TAU	Taupe
DWH	Designer White	VIN	Vintage
DOV	Dove Grey	WLH	Walnut Heights

Order Check List
page 76

Product Specifications
page 40

Power and Data Options
page 214

Undersurface Electrical Options
pages 215-217

WORKSURFACE

Corner
Grommets

SWISH

		Description	① Model	D	W	H	CTN WT	CU FT	List Price	
<p>Right</p>		<p>Corner Worksurface</p> <ul style="list-style-type: none"> · three grommets - left, center and right corners on approach side · 2 1/4" tall acrylic plenum on ends and approach side · 2" black wire management trough · left, center and right support options must be specified, see pages 132 and 138 · center support options include a single leg to floor, single leg to bench height or single spacer to executive height · pedestal restrictions apply, refer to page 76 · optional cutout for EC10 and EC11, see page 214 · optional undersurface electrical includes two duplex units 	Right	SST4872CRNRG-BC-R	48	72	1 3/16	85	13	\$1,571
			Left	SST4872CRNRG-CB-L	48	72	1 3/16	85	13	\$1,571
							Undersurface Electrical Included List Price		\$2,028	
<p>Right</p>		<p>Corner Worksurface</p> <ul style="list-style-type: none"> · three grommets - left, center and right corners on approach side · 2 1/4" tall acrylic plenum on ends and approach side · 2" black wire management trough · left, center and right support options must be specified, see pages 132 and 138 · center support options include a single leg to floor, single leg to bench height or single spacer to executive height · pedestal restrictions apply, refer to page 76 · optional cutout for EC10 and EC11, see page 214 · optional undersurface electrical includes two duplex units 	Right	SST4872CRNRG-BB-R	48	72	1 3/16	78	13	\$1,568
			Left	SST4872CRNRG-BB-L	48	72	1 3/16	78	13	\$1,568
							Undersurface Electrical Included List Price		\$2,025	
<p>Right</p>		<p>Corner Worksurface</p> <ul style="list-style-type: none"> · three grommets - left, center and right corners on approach side · 2 1/4" tall acrylic plenum on ends and approach side · 2" black wire management trough · left, center and right support options must be specified, see pages 132 and 138 · center support options include a single leg to floor, single leg to bench height or single spacer to executive height · pedestal restrictions apply, refer to page 76 · optional cutout for EC10 and EC11, see page 214 · optional undersurface electrical includes two duplex units 	Right	SST4872CRNRG-AB-R	48	72	1 3/16	74	13	\$1,565
			Left	SST4872CRNRG-BA-L	48	72	1 3/16	74	13	\$1,565
							Undersurface Electrical Included List Price		\$2,022	
<p>Right</p>		<p>Corner Worksurface</p> <ul style="list-style-type: none"> · three grommets - left, center and right corners on approach side · 2 1/4" tall acrylic plenum on ends and approach side · 2" black wire management trough · left, center and right support options must be specified, see pages 132 and 138 · center support options include a single leg to floor, single leg to bench height or single spacer to executive height · pedestal restrictions apply, refer to page 76 · optional cutout for EC10 and EC11, see page 214 · optional undersurface electrical includes two duplex units 	Right	SST4872CRNRG-AB-R	48	72	1 3/16	74	13	\$1,565
			Left	SST4872CRNRG-BA-L	48	72	1 3/16	74	13	\$1,565
							Undersurface Electrical Included List Price		\$2,022	
<p>Right</p>		<p>Corner Worksurface</p> <ul style="list-style-type: none"> · three grommets - left, center and right corners on approach side · 2 1/4" tall acrylic plenum on ends and approach side · 2" black wire management trough · left, center and right support options must be specified, see pages 132 and 138 · center support options include a single leg to floor, single leg to bench height or single spacer to executive height · pedestal restrictions apply, refer to page 76 · optional cutout for EC10 and EC11, see page 214 · optional undersurface electrical includes two duplex units 	Right	SST4866CRNRG-BC-R	48	66	1 3/16	79	12	\$1,545
			Left	SST4866CRNRG-CB-L	48	66	1 3/16	79	12	\$1,545
							Undersurface Electrical Included List Price		\$1,998	
<p>Right</p>		<p>Corner Worksurface</p> <ul style="list-style-type: none"> · three grommets - left, center and right corners on approach side · 2 1/4" tall acrylic plenum on ends and approach side · 2" black wire management trough · left, center and right support options must be specified, see pages 132 and 138 · center support options include a single leg to floor, single leg to bench height or single spacer to executive height · pedestal restrictions apply, refer to page 76 · optional cutout for EC10 and EC11, see page 214 · optional undersurface electrical includes two duplex units 	Right	SST4866CRNRG-BC-R	48	66	1 3/16	79	12	\$1,545
			Left	SST4866CRNRG-CB-L	48	66	1 3/16	79	12	\$1,545
							Undersurface Electrical Included List Price		\$1,998	

WORKSURFACE
Corner
Grommets

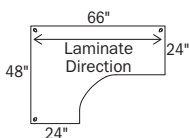
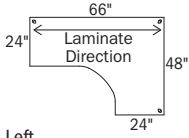
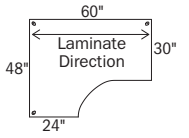
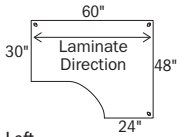
	Description	① Model	D	W	H	CTN WT	CU FT	List Price
 <p>Right</p>	<p>Corner Worksurface</p> <ul style="list-style-type: none"> three grommets - left, center and right corners on approach side 2 1/4" tall acrylic plenum on ends and approach side 2" black wire management trough left, center and right support options must be specified, see pages 132 and 138 center support options include a single leg to floor, single leg to bench height or single spacer to executive height pedestal restrictions apply, refer to page 76 optional cutout for EC10 and EC11, see page 214 optional undersurface electrical includes two duplex units 	Right	48	66	1 3/16	73	12	\$1,537
		Left	48	66	1 3/16	73	12	\$1,537
Undersurface Electrical Included List Price \$1,989								
 <p>Left</p>	<p>Corner Worksurface</p> <ul style="list-style-type: none"> three grommets - left, center and right corners on approach side 2 1/4" tall acrylic plenum on ends and approach side 2" black wire management trough left, center and right support options must be specified, see pages 132 and 138 center support options include a single leg to floor, single leg to bench height or single spacer to executive height pedestal restrictions apply, refer to page 76 optional cutout for EC10 and EC11, see page 214 optional undersurface electrical includes two duplex units 	Right	48	60	1 3/16	73	11	\$1,461
		Left	48	60	1 3/16	73	11	\$1,461
Undersurface Electrical Included List Price \$1,909								
 <p>Right</p>	<p>Corner Worksurface</p> <ul style="list-style-type: none"> three grommets - left, center and right corners on approach side 2 1/4" tall acrylic plenum on ends and approach side 2" black wire management trough left, center and right support options must be specified, see pages 132 and 138 center support options include a single leg to floor, single leg to bench height or single spacer to executive height pedestal restrictions apply, refer to page 76 optional cutout for EC10 and EC11, see page 214 optional undersurface electrical includes two duplex units 	Right	48	60	1 3/16	67	11	\$1,458
		Left	48	60	1 3/16	67	11	\$1,458
Undersurface Electrical Included List Price \$1,906								
 <p>Left</p>	<p>Corner Worksurface</p> <ul style="list-style-type: none"> three grommets - left, center and right corners on approach side 2 1/4" tall acrylic plenum on ends and approach side 2" black wire management trough left, center and right support options must be specified, see pages 132 and 138 center support options include a single leg to floor, single leg to bench height or single spacer to executive height pedestal restrictions apply, refer to page 76 optional cutout for EC10 and EC11, see page 214 optional undersurface electrical includes two duplex units 	Right	48	60	1 3/16	67	11	\$1,458
		Left	48	60	1 3/16	67	11	\$1,458
Undersurface Electrical Included List Price \$1,906								

To Order, Specify:

- ① Model number
- ② Worksurface color
- ③ Product Options (see page 76)

② Laminate Color Options:

ALB	Alabaster	GRH	Graphite
AUT	Autumn	HGL	High Line
BLO	Blonde Echo	SHD	Shadow
BBN	Bourbon	SHE	Shea
BZW	Brazilwood	SLG	Slate Grey
BBL	Bridal Blanco	STU	Studio Teak
BRG	Brighton	TAU	Taupe
DWH	Designer White	VIN	Vintage
DOV	Dove Grey	WLH	Walnut Heights

Order Check List

page 76

Product Specifications

page 40

Power and Data Options

page 214

Undersurface Electrical Options

pages 215-217

WORKSURFACE

120°
Grommets

Description	① Model	D	W	H	CTN WT	CU FT	List Price
<p>120 Degree Worksurface</p>	<p>SST4584YG-BB</p> <ul style="list-style-type: none"> • three grommets - left, center and right corners on approach side • 2 1/4" tall acrylic plenum on ends and approach side • 2" black wire management trough • left, center and right support options must be specified, see pages 132 and 138 • center support must always be a leg to floor • optional cutout for EC10 and EC11, see page 214 • optional undersurface electrical includes two duplex units 	44	83	1 3/16	71	15	\$1,906
		Undersurface Electrical Included List Price					\$2,317
<p>120 Degree Worksurface</p>	<p>SST4273YG-BB</p> <ul style="list-style-type: none"> • three grommets - left, center and right corners on approach side • 2 1/4" tall acrylic plenum on ends and approach side • 2" black wire management trough • left, center and right support options must be specified, see pages 132 and 138 • center support must always be a leg to floor • optional cutout for EC10 and EC11, see page 214 • optional undersurface electrical includes two duplex units 	41	73	1 3/16	61	12	\$1,816
		Undersurface Electrical Included List Price					\$2,219
<p>120 Degree Worksurface</p>	<p>SST3963YG-BB</p> <ul style="list-style-type: none"> • three grommets - left, center and right corners on approach side • 2 1/4" tall acrylic plenum on ends and approach side • 2" black wire management trough • left, center and right support options must be specified, see pages 132 and 138 • center support must always be a leg to floor • optional cutout for EC10 and EC11, see page 214 • optional undersurface electrical includes two duplex units 	38	62	1 3/16	50	10	\$1,523
		Undersurface Electrical Included List Price					\$1,913
<p>120 Degree Worksurface</p>	<p>SST4084YG-AA</p> <ul style="list-style-type: none"> • three grommets - left, center and right corners on approach side • 2 1/4" tall acrylic plenum on ends and approach side • 2" black wire management trough • left, center and right support options must be specified, see pages 132 and 138 • center support must always be a leg to floor • optional cutout for EC10 and EC11, see page 214; due to depth of top, cutout will run perpendicular to user • optional undersurface electrical includes two duplex units 	39	83	1 3/16	57	13	\$1,898
		Undersurface Electrical Included List Price					\$2,307
<p>120 Degree Worksurface</p>	<p>SST3773YG-AA</p> <ul style="list-style-type: none"> • three grommets - left, center and right corners on approach side • 2 1/4" tall acrylic plenum on ends and approach side • 2" black wire management trough • left, center and right support options must be specified, see pages 132 and 138 • center support must always be a leg to floor • optional cutout for EC10 and EC11, see page 214; due to depth of top, cutout will run perpendicular to user • optional undersurface electrical includes two duplex units 	36	73	1 3/16	50	11	\$1,671
		Undersurface Electrical Included List Price					\$2,074
<p>120 Degree Worksurface</p>	<p>SST3463YG-AA</p> <ul style="list-style-type: none"> • three grommets - left, center and right corners on approach side • grain • 2 1/4" tall acrylic plenum on ends and approach side • 2" black wire management trough • left, center and right support options must be specified, see pages 132 and 138 • center support must always be a leg to floor • optional cutout for EC10 and EC11, see page 214; due to depth of top, cutout will run perpendicular to user • optional undersurface electrical includes two duplex units 	33	62	1 3/16	41	9	\$1,309
		Undersurface Electrical Included List Price					\$1,697

WORKSURFACE
Nook
Grommets - Inset 6"

	Description	Model	D	W	H	CTN WT	CU FT	List Price
<p>Right</p>	<p>Nook Worksurface</p> <ul style="list-style-type: none"> two grommets - left and right corners on approach side, inset 6" 2 1/4" tall acrylic plenum on ends and approach side 2" black wire management trough left and right support options must be specified, see pages 132 and 138 pedestal restrictions apply, refer to page 76 optional cutout for EC10 and EC11, see page 214 optional undersurface electrical includes two duplex units 	Right SST3684NKGO-R	36	84	1 3/16	94	12	\$1,486
		Left SST3684NKGO-L	36	84	1 3/16	94	12	\$1,486
Undersurface Electrical Included List Price \$1,842								
<p>Left</p>	<p>Nook Worksurface</p> <ul style="list-style-type: none"> two grommets - left and right corners on approach side, inset 6" 2 1/4" tall acrylic plenum on ends and approach side 2" black wire management trough left and right support options must be specified, see pages 132 and 138 pedestal restrictions apply, refer to page 76 optional cutout for EC10 and EC11, see page 214 optional undersurface electrical includes two duplex units 	Right SST3678NKGO-R	36	78	1 3/16	87	11	\$1,439
		Left SST3678NKGO-L	36	78	1 3/16	87	11	\$1,439
Undersurface Electrical Included List Price \$1,792								
<p>Right</p>	<p>Nook Worksurface</p> <ul style="list-style-type: none"> two grommets - left and right corners on approach side, inset 6" 2 1/4" tall acrylic plenum on ends and approach side 2" black wire management trough left and right support options must be specified, see pages 132 and 138 pedestal restrictions apply, refer to page 76 optional cutout for EC10 and EC11, see page 214 optional undersurface electrical includes two duplex units 	Right SST3672NKGO-R	36	72	1 3/16	83	10	\$1,262
		Left SST3672NKGO-L	36	72	1 3/16	83	10	\$1,262
Undersurface Electrical Included List Price \$1,610								
<p>Left</p>	<p>Nook Worksurface</p> <ul style="list-style-type: none"> two grommets - left and right corners on approach side, inset 6" 2 1/4" tall acrylic plenum on ends and approach side 2" black wire management trough left and right support options must be specified, see pages 132 and 138 pedestal restrictions apply, refer to page 76 optional cutout for EC10 and EC11, see page 214 optional undersurface electrical includes two duplex units 	Right SST3672NKGO-R	36	72	1 3/16	83	10	\$1,262
		Left SST3672NKGO-L	36	72	1 3/16	83	10	\$1,262
Undersurface Electrical Included List Price \$1,610								
<p>Right</p>	<p>Nook Worksurface</p> <ul style="list-style-type: none"> two grommets - left and right corners on approach side, inset 6" 2 1/4" tall acrylic plenum on ends and approach side 2" black wire management trough left and right support options must be specified, see pages 132 and 138 pedestal restrictions apply, refer to page 76 optional cutout for EC10 and EC11, see page 214 optional undersurface electrical includes two duplex units 	Right SST3672NKGO-R	36	72	1 3/16	83	10	\$1,262
		Left SST3672NKGO-L	36	72	1 3/16	83	10	\$1,262
Undersurface Electrical Included List Price \$1,610								
<p>Left</p>	<p>Nook Worksurface</p> <ul style="list-style-type: none"> two grommets - left and right corners on approach side, inset 6" 2 1/4" tall acrylic plenum on ends and approach side 2" black wire management trough left and right support options must be specified, see pages 132 and 138 pedestal restrictions apply, refer to page 76 optional cutout for EC10 and EC11, see page 214 optional undersurface electrical includes two duplex units 	Right SST3672NKGO-R	36	72	1 3/16	83	10	\$1,262
		Left SST3672NKGO-L	36	72	1 3/16	83	10	\$1,262
Undersurface Electrical Included List Price \$1,610								

SWISH

To Order, Specify:

- 1 Model number
- 2 Worksurface color
- 3 Product Options (see page 76)

Laminate Color Options:

ALB Alabaster	GRH Graphite
AUT Autumn	HGL High Line
BLO Blonde Echo	SHD Shadow
BBN Bourbon	SHE Shea
BZW Brazilwood	SLG Slate Grey
BBL Bridal Blanco	STU Studio Teak
BRG Brighton	TAU Taupe
DWH Designer White	VIN Vintage
DOV Dove Grey	WLH Walnut Heights

Order Check List
page 76

Product Specifications
page 40

Power and Data Options
page 214

Undersurface Electrical Options
pages 215-217

WORKSURFACE

Nook
Grommets

HSIMS

	Description	① Model	D	W	H	CTN WT	CU FT	List Price	
<p>Right</p>	<p>Nook Worksurface</p> <ul style="list-style-type: none"> · two grommets - left and right corners on approach side · 2 1/4" tall acrylic plenum on ends and approach side · 2" black wire management trough · left and right support options must be specified, see pages 132 and 138 · optional cutout for EC10 and EC11, see page 214 · pedestal restrictions apply, refer to page 76 · optional undersurface electrical includes two duplex units 	Right	SST3684NKG-R	36	84	1 3/16	94	12	\$1,486
		Left	SST3684NKG-L	36	84	1 3/16	94	12	\$1,486
		Undersurface Electrical Included List Price							
		\$1,842							
<p>Left</p>	<p>Nook Worksurface</p> <ul style="list-style-type: none"> · two grommets - left and right corners on approach side · 2 1/4" tall acrylic plenum on ends and approach side · 2" black wire management trough · left and right support options must be specified, see pages 132 and 138 · optional cutout for EC10 and EC11, see page 214 · pedestal restrictions apply, refer to page 76 · optional undersurface electrical includes two duplex units 	Right	SST3678NKG-R	36	78	1 3/16	87	11	\$1,439
		Left	SST3678NKG-L	36	78	1 3/16	87	11	\$1,439
		Undersurface Electrical Included List Price							
		\$1,792							
<p>Right</p>	<p>Nook Worksurface</p> <ul style="list-style-type: none"> · two grommets - left and right corners on approach side · 2 1/4" tall acrylic plenum on ends and approach side · 2" black wire management trough · left and right support options must be specified, see pages 132 and 138 · optional cutout for EC10 and EC11, see page 214 · pedestal restrictions apply, refer to page 76 · optional undersurface electrical includes two duplex units 	Right	SST3672NKG-R	36	72	1 3/16	83	10	\$1,262
		Left	SST3672NKG-L	36	72	1 3/16	83	10	\$1,262
		Undersurface Electrical Included List Price							
		\$1,610							
<p>Left</p>	<p>Nook Worksurface</p> <ul style="list-style-type: none"> · two grommets - left and right corners on approach side · 2 1/4" tall acrylic plenum on ends and approach side · 2" black wire management trough · left and right support options must be specified, see pages 132 and 138 · optional cutout for EC10 and EC11, see page 214 · pedestal restrictions apply, refer to page 76 · optional undersurface electrical includes two duplex units 	Right	SST3672NKG-R	36	72	1 3/16	83	10	\$1,262
		Left	SST3672NKG-L	36	72	1 3/16	83	10	\$1,262
		Undersurface Electrical Included List Price							
		\$1,610							

WORKSURFACE
Nook
Grommets

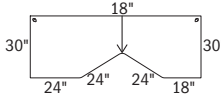
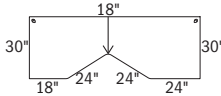
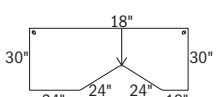
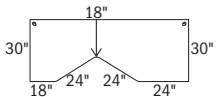
	Description	Model	D	W	H	CTN WT	CU FT	List Price
 <p>Right</p>	<p>Nook Worksurface</p> <ul style="list-style-type: none"> two grommets - left and right corners on approach side 2 1/4" tall acrylic plenum on ends and approach side 2" black wire management trough left and right support options must be specified, see pages 132 and 138 optional cutout for EC10 and EC11, see page 214 pedestal restrictions apply, refer to page 76 optional undersurface electrical includes two duplex units 	SST3084NKG-R	30	84	1 3/16	81	10	\$1,356
		SST3084NKG-L	30	84	1 3/16	81	10	\$1,356
		Undersurface Electrical Included List Price \$1,712						
 <p>Left</p>	<p>Nook Worksurface</p> <ul style="list-style-type: none"> two grommets - left and right corners on approach side 2 1/4" tall acrylic plenum on ends and approach side 2" black wire management trough left and right support options must be specified, see pages 132 and 138 optional cutout for EC10 and EC11, see page 214 pedestal restrictions apply, refer to page 76 optional undersurface electrical includes two duplex units 	SST3078NKG-R	30	78	1 3/16	75	9	\$1,310
		SST3078NKG-L	30	78	1 3/16	75	9	\$1,310
		Undersurface Electrical Included List Price \$1,662						
 <p>Right</p>	<p>Nook Worksurface</p> <ul style="list-style-type: none"> two grommets - left and right corners on approach side 2 1/4" tall acrylic plenum on ends and approach side 2" black wire management trough left and right support options must be specified, see pages 132 and 138 optional cutout for EC10 and EC11, see page 214 pedestal restrictions apply, refer to page 76 optional undersurface electrical includes two duplex units 	SST3072NKG-R	30	72	1 3/16	69	9	\$1,161
		SST3072NKG-L	30	72	1 3/16	69	9	\$1,161
		Undersurface Electrical Included List Price \$1,507						
 <p>Left</p>	<p>Nook Worksurface</p> <ul style="list-style-type: none"> two grommets - left and right corners on approach side 2 1/4" tall acrylic plenum on ends and approach side 2" black wire management trough left and right support options must be specified, see pages 132 and 138 optional cutout for EC10 and EC11, see page 214 pedestal restrictions apply, refer to page 76 optional undersurface electrical includes two duplex units 	SST3072NKG-R	30	72	1 3/16	69	9	\$1,161
		SST3072NKG-L	30	72	1 3/16	69	9	\$1,161
		Undersurface Electrical Included List Price \$1,507						

SWISH

To Order, Specify:

- 1 Model number
- 2 Worksurface color
- 3 Product Options (see page 76)

Laminate Color Options:

ALB Alabaster	GRH Graphite
AUT Autumn	HGL High Line
BLO Blonde Echo	SHD Shadow
BBN Bourbon	SHE Shea
BZW Brazilwood	SLG Slate Grey
BBL Bridal Blanco	STU Studio Teak
BRG Brighton	TAU Taupe
DWH Designer White	VIN Vintage
DOV Dove Grey	WLH Walnut Heights

Order Check List
page 76

Product Specifications
page 40

Power and Data Options
page 214

Undersurface Electrical Options
pages 215-217

WORKSURFACE

Boomerang
Grommets

SWISH

	Description	① Model	D	W	H	CTN WT	CU FT	List Price
<p>Right</p>	<p>Boomerang Worksurface</p> <ul style="list-style-type: none"> · two grommets - left and right corners on approach side · 2 1/4" tall acrylic plenum on ends and approach side · 2" black wire management trough · left, center and right support options must be specified, see pages 132 and 138 · center support must always be a leg to floor · optional cutout for EC10 and EC11, see page 214 · optional undersurface electrical includes two duplex units 	Right	30	84	1 3/16	84	14	\$1,877
		Left	30	84	1 3/16	84	14	\$1,877
		Undersurface Electrical Included List Price						
		\$2,232						
<p>Left</p>								
<p>Right</p>	<p>Boomerang Worksurface</p> <ul style="list-style-type: none"> · two grommets - left and right corners on approach side · 2 1/4" tall acrylic plenum on ends and approach side · 2" black wire management trough · left, center and right support options must be specified, see pages 132 and 138 · center support must always be a leg to floor · optional cutout for EC10 and EC11, see page 214 · optional undersurface electrical includes two duplex units 	Right	24	84	1 3/16	70	12	\$1,620
		Left	24	84	1 3/16	70	12	\$1,620
		Undersurface Electrical Included List Price						
		\$1,976						
<p>Left</p>								

WORKSURFACE
Return
Grommets

	Description	① Model	D	W	H	CTN WT	CU FT	List Price	
	24" Deep Return	Right SST6024RTRNG-R	24	60	1 3/16	52	6	\$637	
	· two grommets - left and right corners on approach side	Left SST6024RTRNG-L	24	60	1 3/16	52	6	\$637	
	· 2 1/4" tall acrylic plenum	Undersurface Electrical Included List Price							\$976
	· 2" black wire management trough								
	· perpendicular grain to user side								
	· optional cutout for EC10 and EC11, see page 214								
	· optional undersurface electrical includes two duplex units								
	· mounting bracket attaches to desk worksurface, support option must be specified for opposite end of return								
	24" Deep Return	Right SST5424RTRNG-R	24	54	1 3/16	47	6	\$605	
	· two grommets - left and right corners on approach side	Left SST5424RTRNG-L	24	54	1 3/16	47	6	\$605	
	· 2 1/4" tall acrylic plenum	Undersurface Electrical Included List Price							\$872
	· 2" black wire management trough								
· perpendicular grain to user side									
· optional cutout for EC10 and EC11, see page 214									
· optional undersurface electrical includes one duplex unit									
· mounting bracket attaches to desk worksurface, support option must be specified for opposite end of return									
24" Deep Return	Right SST4824RTRNG-R	24	48	1 3/16	42	5	\$563		
· two grommets - left and right corners on approach side	Left SST4824RTRNG-L	24	48	1 3/16	42	5	\$563		
· 2 1/4" tall acrylic plenum	Undersurface Electrical Included List Price							\$825	
· 2" black wire management trough									
· perpendicular grain to user side	Right SST4224RTRNG-R	24	42	1 3/16	36	4	\$491		
· optional cutout for EC10 and EC11, see page 214	Left SST4224RTRNG-L	24	42	1 3/16	36	4	\$491		
· optional undersurface electrical includes one duplex unit	Undersurface Electrical Included List Price							\$748	
· mounting bracket attaches to desk worksurface, support option must be specified for opposite end of return	Right SST3624RTRNG-R	24	36	1 3/16	31	4	\$461		
	Left SST3624RTRNG-L	24	36	1 3/16	31	4	\$461		
	Undersurface Electrical Included List Price							\$675	
	Right SST3024RTRNG-R	24	30	1 3/16	26	3	\$435		
	Left SST3024RTRNG-L	24	30	1 3/16	26	3	\$435		
	Undersurface Electrical Included List Price							\$603	

SWISH

To Order, Specify:

- ① Model number
- ② Worksurface color
- ③ Product Options (see page 76)

② Laminate Color Options:

ALB Alabaster	GRH Graphite
AUT Autumn	HGL High Line
BLO Blonde Echo	SHD Shadow
BBN Bourbon	SHE Shea
BZW Brazilwood	SLG Slate Grey
BBL Bridal Blanco	STU Studio Teak
BRG Brighton	TAU Taupe
DWH Designer White	VIN Vintage
DOV Dove Grey	WLH Walnut Heights

Order Check List
page 76

Product Specifications
page 40

Power and Data Options
page 214

Undersurface Electrical Options
pages 215-217

WORKSURFACE

Return
Grommets

	Description	① Model	D	W	H	CTN WT	CU FT	List Price		
	18" Deep Return · two grommets - left and right corners on approach side · 2 1/4" tall acrylic plenum · 2" black wire management trough · perpendicular grain to user side · optional cutout for EC10 and EC11, see page 214; due to depth of top, cutout will run perpendicular to user · EC unit may be specified over pedestal side only · optional undersurface electrical includes two duplex units · mounting bracket attaches to desk worksurface, support option must be specified for opposite end of return	Right	SST6018RTRNG-R	18	60	1 3/16	41	5	\$570	
		Left	SST6018RTRNG-L	18	60	1 3/16	41	5	\$570	
		Undersurface Electrical Included List Price								\$909
		Right	SST5418RTRNG-R	18	54	1 3/16	37	4	\$535	
		Left	SST5418RTRNG-L	18	54	1 3/16	37	4	\$535	
		Undersurface Electrical Included List Price								\$802
		Right	SST4818RTRNG-R	18	48	1 3/16	33	4	\$507	
		Left	SST4818RTRNG-L	18	48	1 3/16	33	4	\$507	
		Undersurface Electrical Included List Price								\$768
		Right	SST4218RTRNG-R	18	42	1 3/16	28	4	\$438	
		Left	SST4218RTRNG-L	18	42	1 3/16	28	4	\$438	
		Undersurface Electrical Included List Price								\$696
Right	SST3618RTRNG-R	18	36	1 3/16	24	3	\$415			
Left	SST3618RTRNG-L	18	36	1 3/16	24	3	\$415			
Undersurface Electrical Included List Price								\$627		
Right	SST3018RTRNG-R	18	30	1 3/16	21	3	\$393			
Left	SST3018RTRNG-L	18	30	1 3/16	21	3	\$393			
Undersurface Electrical Included List Price								\$562		

SWISH

WORKSURFACE
Bridge
Grommets

Description	① Model	D	W	H	CTN WT	CU FT	List Price	
24" Deep Bridge 	SST6024BRDGG · two grommets - left and right corners on approach side · 2 1/4" tall acrylic plenum · 2" black wire management trough · perpendicular grain to user side · optional cutout for EC10 and EC11, see page 214 · optional undersurface electrical includes two duplex units · ships with mounting brackets	24	60	1 3/16	52	6	\$653	
	Undersurface Electrical Included List Price							\$991
	SST5424BRDGG · two grommets - left and right corners on approach side · 2 1/4" tall acrylic plenum · 2" black wire management trough · perpendicular grain to user side · optional cutout for EC10 and EC11, see page 214 · optional undersurface electrical includes one duplex unit · ships with mounting brackets	24	54	1 3/16	47	6	\$613	
	Undersurface Electrical Included List Price							\$879
	SST4824BRDGG · two grommets - left and right corners on approach side · 2 1/4" tall acrylic plenum · 2" black wire management trough · perpendicular grain to user side · optional cutout for EC10 and EC11, see page 214 · optional undersurface electrical includes one duplex unit · ships with mounting brackets	24	48	1 3/16	42	5	\$577	
	Undersurface Electrical Included List Price							\$839
	SST4224BRDGG · two grommets - left and right corners on approach side · 2 1/4" tall acrylic plenum · 2" black wire management trough · perpendicular grain to user side · optional cutout for EC10 and EC11, see page 214 · optional undersurface electrical includes one duplex unit · ships with mounting brackets	24	42	1 3/16	36	4	\$504	
Undersurface Electrical Included List Price							\$763	
SST3624BRDGG · two grommets - left and right corners on approach side · 2 1/4" tall acrylic plenum · 2" black wire management trough · perpendicular grain to user side · optional cutout for EC10 and EC11, see page 214 · optional undersurface electrical includes one duplex unit · ships with mounting brackets	24	36	1 3/16	31	4	\$477		
Undersurface Electrical Included List Price							\$690	
SST3024BRDGG · two grommets - left and right corners on approach side · 2 1/4" tall acrylic plenum · 2" black wire management trough · perpendicular grain to user side · optional cutout for EC10 and EC11, see page 214 · optional undersurface electrical includes one duplex unit · ships with mounting brackets	24	30	1 3/16	26	3	\$451		
Undersurface Electrical Included List Price							\$619	

SWISH

To Order, Specify:

- ① Model number
- ② Worksurface color
- ③ Product Options (see page 76)

② Laminate Color Options:

ALB Alabaster	GRH Graphite
AUT Autumn	HGL High Line
BLO Blonde Echo	SHD Shadow
BBN Bourbon	SHE Shea
BZW Brazilwood	SLG Slate Grey
BBL Bridal Blanco	STU Studio Teak
BRG Brighton	TAU Taupe
DWH Designer White	VIN Vintage
DOV Dove Grey	WLH Walnut Heights

Order Check List

page 76

Product Specifications

page 40

Power and Data Options

page 214

Undersurface Electrical Options

pages 215-217

WORKSURFACE

Bridge
Grommets

Description	① Model	D	W	H	CTN WT	CU FT	List Price
18" Deep Bridge 	SST6018BRDGG · two grommets - left and right corners on approach side · 2 1/4" tall acrylic plenum · 2" black wire management trough · perpendicular grain to user side · optional undersurface electrical includes two duplex units · ships with mounting brackets	18	60	1 3/16	41	5	\$580
		Undersurface Electrical Included List Price					\$918
	SST5418BRDGG · two grommets - left and right corners on approach side · 2 1/4" tall acrylic plenum · 2" black wire management trough · perpendicular grain to user side · optional undersurface electrical includes one duplex unit · ships with mounting brackets	18	54	1 3/16	37	4	\$545
		Undersurface Electrical Included List Price					\$811
	SST4818BRDGG · two grommets - left and right corners on approach side · 2 1/4" tall acrylic plenum · 2" black wire management trough · perpendicular grain to user side · optional undersurface electrical includes one duplex unit · ships with mounting brackets	18	48	1 3/16	33	4	\$515
		Undersurface Electrical Included List Price					\$776
	SST4218BRDGG · two grommets - left and right corners on approach side · 2 1/4" tall acrylic plenum · 2" black wire management trough · perpendicular grain to user side · optional undersurface electrical includes one duplex unit · ships with mounting brackets	18	42	1 3/16	28	4	\$447
		Undersurface Electrical Included List Price					\$704
	SST3618BRDGG · two grommets - left and right corners on approach side · 2 1/4" tall acrylic plenum · 2" black wire management trough · perpendicular grain to user side · optional undersurface electrical includes one duplex unit · ships with mounting brackets	18	36	1 3/16	24	3	\$425
		Undersurface Electrical Included List Price					\$638
	SST3018BRDGG · two grommets - left and right corners on approach side · 2 1/4" tall acrylic plenum · 2" black wire management trough · perpendicular grain to user side · optional undersurface electrical includes one duplex unit · ships with mounting brackets	18	30	1 3/16	21	3	\$403
		Undersurface Electrical Included List Price					\$571

To Order, Specify:

- ① Model number
- ② Worksurface color
- ③ Product Options (see page 76)

② Laminate Color Options:

ALB Alabaster	GRH Graphite
AUT Autumn	HGL High Line
BLO Blonde Echo	SHD Shadow
BBN Bourbon	SHE Shea
BZW Brazilwood	SLG Slate Grey
BBL Bridal Blanco	STU Studio Teak
BRG Brighton	TAU Taupe
DWH Designer White	VIN Vintage
DOV Dove Grey	WLH Walnut Heights

Order Check List

page 76

Product Specifications

page 40

Power and Data Options

page 214

Undersurface Electrical Options

pages 215-217

Modular Executive Height Storage Order Check List:

Specify:

- 1. Model number
- 2. Laminate color

Example:

SS2418MFF | **AUT**
 (model #) | (laminate color)

1. Model number

2. Laminate Color Options:

ALB	Alabaster	GRH	Graphite
AUT	Autumn	HGL	High Line
BLO	Blonde Echo	SHD	Shadow
BBN	Bourbon	SHE	Shea
BZW	Brazilwood	SLG	Slate Grey
BBL	Bridal Blanco	STU	Studio Teak
BRG	Brighton	TAU	Taupe
DWH	Designer White	VIN	Vintage
DOV	Dove Grey	WLH	Walnut Heights

Pull Style and Color:



Flat (Alloy finish)

NOTE: All drawers are predrilled for easy field installation. Pulls for drawers can be installed in the left, center or right locations. All hinged doors are predrilled as well.

Counterweights:

In order to pass stability tests some Executive Height Storage units will require a counterweight to be mounted on the inside of the back panel of the unit. The 1/2" thick counterweight is available in 10 lb. and 20 lb. weights and is field installed. The counterweight will need to be ordered separately, see page 131. Some units may require 40 lbs. of counterweight; in that case two 20 lb. counterweights will need to be ordered. As an alternative to the counterweight the unit can be secured to the wall or floor.

MODULAR EXECUTIVE HEIGHT STORAGE

Description	① Model	D	W	H	CTN WT	CU FT	List Price
 <p>Executive Height - Box/Box/File · top grommet · vertical wire access through pedestal · worksurface top must be ordered separately, see pages 77-124 · 18" wide front locking pedestal · field installed pulls · 24" and 18" deep pedestals cannot be used as freestanding pedestals</p>	SS3618MBBF	36	18	26	128	13	\$974
	SS3018MBBF	30	18	26	118	11	\$922
	SS2418MBBF	24	18	26	105	9	\$844
	SS1818MBBF	18	18	26	92	7	\$796

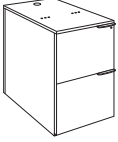
 <p>Executive Height - File/File · top grommet · vertical wire access through pedestal · worksurface top must be ordered separately, see pages 77-124 · 18" wide front locking pedestal · field installed pulls · 24" and 18" deep pedestals cannot be used as freestanding pedestals</p>	SS3618MFF	36	18	26	129	13	\$953
	SS3018MFF	30	18	26	119	11	\$900
	SS2418MFF	24	18	26	106	9	\$823
	SS1818MFF	18	18	26	93	7	\$776

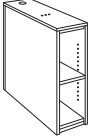
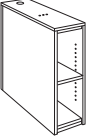
Executive Height - Open Storage		Model	D	W	H	CTN WT	CU FT	List Price
  <p>Executive Height - Open Storage · top grommet · adjustable shelf · worksurface top must be ordered separately, see pages 77-124</p>	Right	SS3009MROS	30	9	26	67	6	\$592
	Left	SS3009MLOS	30	9	26	67	6	\$592
	Right	SS2409MROS	24	9	26	57	5	\$555
	Left	SS2409MLOS	24	9	26	57	5	\$555
	Right	SS1809MROS	18	9	26	46	4	\$517
	Left	SS1809MLOS	18	9	26	46	4	\$517

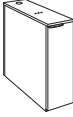
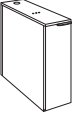
  <p>Executive Height - Hinged Door · top grommet · adjustable shelf · worksurface top must be ordered separately, see pages 77-124 · non-locking door standard; locking door available, specify and add \$105 list · field installed pull</p>	Right	SS3009MRHD	30	9	26	73	6	\$626
	Left	SS3009MLHD	30	9	26	73	6	\$626
	Right	SS2409MRHD	24	9	26	63	5	\$607
	Left	SS2409MLHD	24	9	26	63	5	\$607
	Right	SS1809MRHD	18	9	26	52	4	\$571
	Left	SS1809MLHD	18	9	26	52	4	\$571

MODULAR EXECUTIVE HEIGHT STORAGE

		Description	① Model	D	W	H	CTN WT	CU FT	List Price	
	Right	Executive Height - Extended Lateral File · top grommet · vertical wire access through pedestal · worksurface top must be ordered separately, see pages 77-124 · extended pedestal application · for application of extended pedestal see typical SS0502 on page 53 and typical SS0602 on page 54 · pedestal front locking · two 20 lb. counterweights required for 18" deep units, see page 131 for counterweight · unit can be secured to wall or floor as alternative to counterweight · field installed pulls	Right	SS3036MLFER	30	36	26	193	20	\$1,274
	Left		Left	SS3036MLFEL	30	36	26	193	20	\$1,274
	Right		Right	SS2436MLFER	24	36	26	173	17	\$1,181
	Left		Left	SS2436MLFEL	24	36	26	173	17	\$1,181
	Right		Right	SS1836MLFER	18	36	26	143	13	\$1,090
	Left		Left	SS1836MLFEL	18	36	26	143	13	\$1,090

	Right	Executive Height - Extended Multi-File · top grommet · vertical wire access through pedestal · worksurface top must be ordered separately, see pages 77-124 · extended pedestal application · for application of extended pedestal see typical SS0502 on page 53 and typical SS0602 on page 54 · pedestal front locking · two 20 lb. counterweights required for 18" deep units, see page 131 for counterweight · unit can be secured to wall or floor as alternative to counterweight · field installed pulls	Right	SS3036MMFER	30	36	26	202	20	\$1,337
	Left		Left	SS3036MMFEL	30	36	26	202	20	\$1,337
	Right		Right	SS2436MMFER	24	36	26	182	17	\$1,253
	Left		Left	SS2436MMFEL	24	36	26	182	17	\$1,253
	Right		Right	SS1836MMFER	18	36	26	158	13	\$1,137
	Left		Left	SS1836MMFEL	18	36	26	158	13	\$1,137

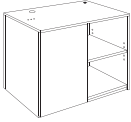
	Right	Executive Height - Extended Sliding Door · top grommet · adjustable shelf · worksurface top must be ordered separately, see pages 77-124 · extended pedestal application · for application of extended pedestal see typical SS0502 on page 53 and typical SS0602 on page 54 · locking door not available	Right	SS2436MSDER	24	36	26	133	17	\$1,017
	Left		Left	SS2436MSDEL	24	36	26	133	17	\$1,017
	Right		Right	SS1836MSDER	18	36	26	109	13	\$936
	Left		Left	SS1836MSDEL	18	36	26	109	13	\$936

To Order, Specify:

- ① Model number
- ② Laminate color

② Laminate Color Options:

ALB	Alabaster	GRH	Graphite
AUT	Autumn	HGL	High Line
BLO	Blonde Echo	SHD	Shadow
BBN	Bourbon	SHE	Shea
BZW	Brazilwood	SLG	Slate Grey
BBL	Bridal Blanco	STU	Studio Teak
BRG	Brighton	TAU	Taupe
DWH	Designer White	VIN	Vintage
DOV	Dove Grey	WLH	Walnut Heights

Order Check List
page 125

Product Specifications
page 40

MODULAR EXECUTIVE HEIGHT STORAGE

Description		① Model	D	W	H	CTN WT	CU FT	List Price
	Executive Height - Connection Pedestal	SS2436MRO	24	36	26	125	17	\$857
	· two top grommets							
	· pass through rectangular side grommets	SS1836MRO	18	36	26	101	13	\$737
	· adjustable shelf							
	· worksurface top must be ordered separately, see pages 77-124	SS2430MRO	24	30	26	110	14	\$809
	· to be used with peninsula top style application with bench low height storage on either side	SS1830MRO	18	30	26	90	11	\$698
	Executive Height - Connection Pedestal	SS2424MRO	24	24	26	95	11	\$758
	· one top grommet							
	· pass through rectangular side grommets	SS1824MRO	18	24	26	77	9	\$655
	· adjustable shelf							
	· worksurface top must be ordered separately, see pages 77-124	SS2418MRO	24	18	26	80	9	\$696
	· to be used with peninsula top style application with bench low height storage on either side	SS1818MRO	18	18	26	65	7	\$607
	Executive Height - Open Corner Pedestal	Right SS3624MROC	36	24	26	121	17	\$832
	· top and user side grommets	Left SS3624MLOC	36	24	26	121	17	\$832
	· fixed shelf	Right SS3618MROC	36	18	26	98	13	\$732
	· worksurface top must be ordered separately, see pages 77-124	Left SS3618MLOC	36	18	26	98	13	\$732
		Right SS3024MROC	30	24	26	107	14	\$785
		Left SS3024MLOC	30	24	26	107	14	\$785
		Right SS3018MROC	30	18	26	86	11	\$682
		Left SS3018MLOC	30	18	26	86	11	\$682
		Right SS2424MROC	24	24	26	89	11	\$734
		Left SS2424MLOC	24	24	26	89	11	\$734
		Right SS2418MROC	24	18	26	73	9	\$639
		Left SS2418MLOC	24	18	26	73	9	\$639
		Right SS1824MROC	18	24	26	80	9	\$696
		Left SS1824MLOC	18	24	26	80	9	\$696
		Right SS1818MROC	18	18	26	65	7	\$605
		Left SS1818MLOC	18	18	26	65	7	\$605
	Executive Height - Open Corner Pedestal	Right SS3609MROC	36	9	26	64	7	\$609
	· top and user side grommets	Left SS3609MLOC	36	9	26	64	7	\$609
	· worksurface top must be ordered separately, see pages 77-124	Right SS3009MROC	30	9	26	55	6	\$574
		Left SS3009MLOC	30	9	26	55	6	\$574
		Right SS2409MROC	24	9	26	49	5	\$551
		Left SS2409MLOC	24	9	26	49	5	\$551
		Right SS1809MROC	18	9	26	43	4	\$527
		Left SS1809MLOC	18	9	26	43	4	\$527

MODULAR EXECUTIVE HEIGHT STORAGE

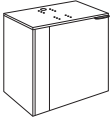
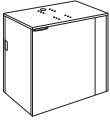
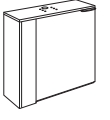
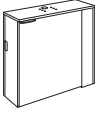
Description		① Model	D	W	H	CTN WT	CU FT	List Price		
 Right	 Left	Executive Height - Hinged Door Corner Pedestal	Right	SS3024MRHDC	30	24	26	119	14	\$885
		Left	SS3024MLHDC	30	24	26	119	14	\$885	
		· top and user side grommets · worksurface top must be ordered separately, see pages 77-124 · non-locking door standard; locking door available, specify and add \$105 list · field installed pull	Right	SS3018MRHDC	30	18	26	99	11	\$790
			Left	SS3018MLHDC	30	18	26	99	11	\$790
			Right	SS2424MRHDC	24	24	26	95	11	\$825
			Left	SS2424MLHDC	24	24	26	95	11	\$825
			Right	SS2418MRHDC	24	18	26	83	9	\$737
			Left	SS2418MLHDC	24	18	26	83	9	\$737
			Right	SS1824MRHDC	18	24	26	83	9	\$783
			Left	SS1824MLHDC	18	24	26	83	9	\$783
			Right	SS1818MRHDC	18	18	26	73	7	\$698
			Left	SS1818MLHDC	18	18	26	73	7	\$698
 Right	 Left	Executive Height - Hinged Door Corner Pedestal	Right	SS3009MRHDC	30	9	26	68	6	\$684
		Left	SS3009MLHDC	30	9	26	68	6	\$684	
		· top and user side grommets · worksurface top must be ordered separately, see pages 77-124 · non-locking door standard; locking door available, specify and add \$105 list · field installed pull	Right	SS2409MRHDC	24	9	26	59	5	\$648
			Left	SS2409MLHDC	24	9	26	59	5	\$648
			Right	SS1809MRHDC	18	9	26	51	4	\$618
			Left	SS1809MLHDC	18	9	26	51	4	\$618

SWISH

To Order, Specify:

- ① Model number
- ② Laminate color



② Laminate Color Options:

ALB	Alabaster	GRH	Graphite
AUT	Autumn	HGL	High Line
BLO	Blonde Echo	SHD	Shadow
BBN	Bourbon	SHE	Shea
BZW	Brazilwood	SLG	Slate Grey
BBL	Bridal Blanco	STU	Studio Teak
BRG	Brighton	TAU	Taupe
DWH	Designer White	VIN	Vintage
DOV	Dove Grey	WLH	Walnut Heights

Order Check List
page 125

Product Specifications
page 40

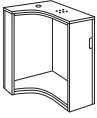
MODULAR EXECUTIVE HEIGHT STORAGE

Description		① Model	D	W	H	CTN WT	CU FT	List Price
 Right  Left	Executive Height - Open Kneespace Corner Pedestal	Right SS3624MKRC	36	24	26	92	17	\$806
	<ul style="list-style-type: none"> · top user and side grommets · worksurface top must be ordered separately, see pages 77-124 	Left SS3624MKLC	36	24	26	92	17	\$806
	Right SS3618MKRC	36	18	26	82	13	\$701	
	Left SS3618MKLC	36	18	26	82	13	\$701	
	Right SS3024MKRC	30	24	26	87	14	\$792	
	Left SS3024MKLC	30	24	26	87	14	\$792	
	Right SS3018MKRC	30	18	26	79	11	\$689	
	Left SS3018MKLC	30	18	26	79	11	\$689	
	Right SS2424MKRC	24	24	26	75	11	\$745	
	Left SS2424MKLC	24	24	26	75	11	\$745	
	Right SS2418MKRC	24	18	26	67	9	\$647	
	Left SS2418MKLC	24	18	26	67	9	\$647	
	Right SS1824MKRC	18	24	26	68	9	\$699	
	Left SS1824MKLC	18	24	26	68	9	\$699	
Right SS1818MKRC	18	18	26	61	7	\$607		
Left SS1818MKLC	18	18	26	61	7	\$607		

	Executive Height - Box/Box/Lateral File	SS2436MBBF	24	36	26	174	17	\$1,305
	<ul style="list-style-type: none"> · two top grommets · vertical wire access through pedestal · worksurface top must be ordered separately, see pages 77-124 	SS1836MBBF	18	36	26	144	13	\$1,209
	<ul style="list-style-type: none"> · pedestal front locking · two 20 lb. counterweights required for 18" deep units, see page 131 for counterweight 	SS2430MBBF	24	30	26	154	14	\$1,170
	<ul style="list-style-type: none"> · unit can be secured to wall or floor as alternative to counterweight · field installed pulls 	SS1830MBBF	18	30	26	128	11	\$1,100

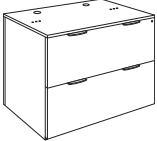
	Executive Height - Lateral File	SS2436MLF	24	36	26	173	17	\$1,270
	<ul style="list-style-type: none"> · two top grommets · vertical wire access through pedestal · worksurface top must be ordered separately, see pages 77-124 	SS1836MLF	18	36	26	143	13	\$1,179
	<ul style="list-style-type: none"> · pedestal front locking · one 20 lb. counterweight required for 24" deep units, two 20 lb. counterweights required for 18" deep units, see page 131 for counterweight 	SS2430MLF	24	30	26	153	14	\$1,143
	<ul style="list-style-type: none"> · unit can be secured to wall or floor as alternative to counterweight · field installed pulls 	SS1830MLF	18	30	26	127	11	\$1,071

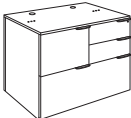
 Right  Left	Executive Height - Multi-File	Right SS2436MMFR	24	36	26	182	17	\$1,342
	<ul style="list-style-type: none"> · two top grommets · vertical wire access through pedestal · worksurface top must be ordered separately, see pages 77-124 	Left SS2436MMFL	24	36	26	182	17	\$1,342
	<ul style="list-style-type: none"> · pedestal front locking · two 20 lb. counterweights required for 18" deep units, see page 131 for counterweight 	Right SS1836MMFR	18	36	26	158	13	\$1,225
	<ul style="list-style-type: none"> · unit can be secured to wall or floor as alternative to counterweight · field installed pulls 	Left SS1836MMFL	18	36	26	158	13	\$1,225

MODULAR EXECUTIVE HEIGHT STORAGE

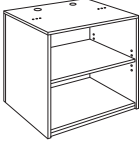
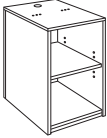
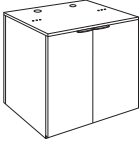
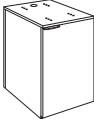
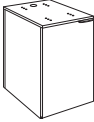
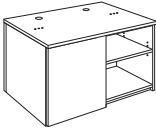
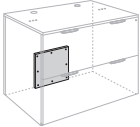
	Description	① Model	D	W	H	CTN WT	CU FT	List Price
	Executive Height - Open Shelf · two top grommets · adjustable shelf · worksurface top must be ordered separately, see pages 77-124	SS2436MOS	24	36	26	125	17	\$886
		SS1836MOS	18	36	26	101	13	\$809
		SS2430MOS	24	30	26	110	14	\$795
		SS1830MOS	18	30	26	90	11	\$727
	Executive Height - Open Shelf · one top grommet · adjustable shelf · worksurface top must be ordered separately, see pages 77-124	SS2418MOS	24	18	26	80	9	\$635
		SS1818MOS	18	18	26	65	7	\$588
	Executive Height - Hinged Doors · two top grommets · worksurface top must be ordered separately, see pages 77-124 · non-locking doors standard; locking doors available, specify and add \$105 list · field installed pulls	SS2436MHD	24	36	26	148	17	\$1,016
		SS1836MHD	18	36	26	125	13	\$939
		SS2430MHD	24	30	26	131	14	\$914
		SS1830MHD	18	30	26	110	11	\$846
  <p>Right Left</p>	Executive Height - Hinged Door · top grommet · worksurface top must be ordered separately, see pages 77-124 · non-locking door standard; locking door available, specify and add \$105 list · field installed pull	Right SS2418MHR	24	18	26	91	9	\$701
		Left SS2418MHL	24	18	26	91	9	\$701
		Right SS1818MHR	18	18	26	75	7	\$651
		Left SS1818MHL	18	18	26	75	7	\$651
	Executive Height - Sliding Door · two top grommets · center divider panel · worksurface top must be ordered separately, see pages 77-124 · adjustable shelf left and right · locking door not available	SS2436MSD	24	36	26	133	17	\$1,105
		SS1836MSD	18	36	26	109	13	\$1,025
		SS2430MSD	24	30	26	120	14	\$1,014
		SS1830MSD	18	30	26	98	11	\$942
	20 lb. Counterweight · attaches to inside back panel of unit · field installed · hardware included	SS20LB	1/2	12	11 1/4	21	1	\$184
	10 lb. Counterweight · attaches to inside back panel of unit · field installed · hardware included	SS10LB	1/2	12	6	11	1	\$93

To Order, Specify:

- ① Model number
- ② Laminate color

② Laminate Color Options:

ALB Alabaster	GRH Graphite
AUT Autumn	HGL High Line
BLO Blonde Echo	SHD Shadow
BBN Bourbon	SHE Shea
BZW Brazilwood	SLG Slate Grey
BBL Bridal Blanco	STU Studio Teak
BRG Brighton	TAU Taupe
DWH Designer White	VIN Vintage
DOV Dove Grey	WLH Walnut Heights

Order Check List
page 125

Product Specifications
page 40

WORKSURFACE SUPPORTS

	Description	Model	CTN WT	CU FT	List Price
	Spacer to Executive Height Storage	SSK-TOPSPACER2 · kit contains two spacers · used with executive height undersurface storage units · silver finish	1	1	\$52
	Spacer to Executive Height Storage	SSK-TOPSPACER1 · kit contains one spacer · used with executive height undersurface storage units · may be used as center support for corner worksurfaces with executive height storage units · silver finish	1	1	\$44
	Leg to Floor	SSK-LEG2-29 · kit contains two legs · silver finish	6	2	\$412
	Leg to Floor	SSK-LEG1-29 · kit contains one leg · required center support for 120° and Boomerang worksurface tops · may be used as center support for corner worksurface tops · silver finish	3	1	\$206
	Leg to Bench Height	SSK-BTD2-29 · kit contains two legs · silver finish	4	1	\$260
	Leg to Bench Height	SSK-BTD1-29 · kit contains one leg · may be used as center support for corner worksurfaces with bench height storage units · silver finish	3	1	\$131
	Bracket to Tall Storage	SSK-LBRKT-36 · typically used with 36" deep tops · mounts to tall storage unit · includes one each SSK-TOPSPACER1 for use with plenum · silver finish	3	1	\$82
	Bracket to Tall Storage	SSK-LBRKT-30 · typically used with 30" deep tops · mounts to tall storage unit · includes one each of SSK-TOPSPACER1 for use with plenum · silver finish	3	1	\$77
	Bracket to Tall Storage	SSK-LBRKT-24 · typically used with 24" deep tops · mounts to tall storage unit · includes one each of SSK-TOPSPACER1 for use with plenum · silver finish	2	1	\$71
	Bracket to Tall Storage	SSK-LBRKT-18 · typically used with 18" deep tops · mounts to tall storage unit · includes one each of SSK-TOPSPACER1 for use with plenum · silver finish	2	1	\$67

SWISH

Modular Bench Height Storage Order Check List:

Specify:

- 1. Model number
- 2. Laminate color

Example:

SSB2436MSD | WH
 (model #) | (laminate color)

1. Model number
2. Laminate Color Options:

ALB	Alabaster	GRH	Graphite
AUT	Autumn	HGL	High Line
BLO	Blonde Echo	SHD	Shadow
BBN	Bourbon	SHE	Shea
BZW	Brazilwood	SLG	Slate Grey
BBL	Bridal Blanco	STU	Studio Teak
BRG	Brighton	TAU	Taupe
DWH	Designer White	VIN	Vintage
DOV	Dove Grey	WLH	Walnut Heights

Pull Style and Color:

Flat (Alloy finish)

NOTE: All drawers are predrilled for easy field installation. Pulls for drawers can be installed in the left, center or right locations. All hinged doors are predrilled as well.



Counterweights:

In order to pass stability tests some Bench Height Storage units will require a counterweight to be mounted on the inside of the back panel of the unit. The 1/2" thick counterweight is available in 10 lb. and 20 lb. weights and is field installed. The counterweight will need to be ordered separately, see page 137. Some units may require 40 lbs. of counterweight; in that case two 20 lb. counterweights will need to be ordered. As an alternative to the counterweight the unit can be secured to the wall or floor.

MODULAR BENCH HEIGHT STORAGE

	Description	① Model	D	W	H	CTN WT	CU FT	List Price		
	Bench Height - Box/Lateral File · vertical wire access through pedestal · pass through rectangular side grommets · modular top required, see pages 136-137 · locking standard · if more than two thirds of the area under the common top is occupied by cabinets with a file drawer a 20 lb. counterweight will be required for 24" deep units while two 20 lb. counterweights will be required for 18" deep units, see page 137 for counterweight · unit can be secured to wall or floor as alternative to counterweight · field installed pulls	SSB2436MBF	24	36	19 1/4	114	12	\$875		
		SSB1836MBF	18	36	19 1/4	101	10	\$829		
	Bench Height - Box/Lateral File · vertical wire access through pedestal · pass through rectangular side grommets · modular top required, see pages 136-137 · locking standard · if more than two thirds of the area under the common top is occupied by cabinets with a file drawer a 20 lb. counterweight will be required for 24" deep units while two 20 lb. counterweights will be required for 18" deep units, see page 137 for counterweight · unit can be secured to wall or floor as alternative to counterweight · field installed pulls	SSB2430MBF	24	30	19 1/4	102	10	\$815		
		SSB1830MBF	18	30	19 1/4	90	8	\$772		
	Bench Height - Box/File · vertical wire access through pedestal · pass through rectangular side grommets · modular top required, see pages 136-137 · locking standard · if more than two thirds of the area under the common top is occupied by cabinets with a file drawer a 10 lb. counterweight will be required for 24" deep units while a 20 lb. counterweight will be required for 18" deep units, see page 137 for counterweight · field installed pulls	SSB2424MBF	24	24	19 1/4	87	8	\$708		
		SSB1824MBF	18	24	19 1/4	77	7	\$666		
		SSB2418MBF	24	18	19 1/4	78	7	\$658		
		SSB1818MBF	18	18	19 1/4	69	5	\$626		
				SSB2436MHD	24	36	19 1/4	104	12	\$680
				SSB1836MHD	18	36	19 1/4	88	10	\$642
	Bench Height - Hinged Doors · wire access through top of chassis · pass through rectangular side grommets · adjustable shelf · modular top required, see pages 136-137 · non-locking · field installed pulls	SSB2430MHD	24	30	19 1/4	92	10	\$632		
		SSB1830MHD	18	30	19 1/4	72	8	\$588		
		SSB2424MHD	24	24	19 1/4	72	8	\$584		
		SSB1824MHD	18	24	19 1/4	61	7	\$549		
				SSB2436MHD	24	36	19 1/4	104	12	\$680
				SSB1836MHD	18	36	19 1/4	88	10	\$642

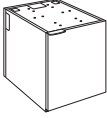
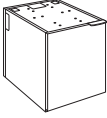
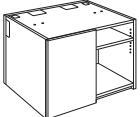
MODULAR BENCH HEIGHT STORAGE

		Description	① Model	D	W	H	CTN WT	CU FT	List Price
 Right	 Left	Bench Height - Hinged Door · wire access through top of chassis · pass through rectangular side grommets · adjustable shelf · modular top required, see pages 136-137 · non-locking door standard; locking door available, specify and add \$105 list · field installed pulls	Right	24	18	19 1/4	66	7	\$540
			Left	SSB2418MHL	24	18	19 1/4	66	7
		Bench Height - Hinged Door · wire access through top of chassis · pass through rectangular side grommets · adjustable shelf · modular top required, see pages 136-137 · non-locking door standard; locking door available, specify and add \$105 list · field installed pulls	Right	18	18	19 1/4	55	5	\$503
			Left	SSB1818MHL	18	18	19 1/4	55	5
	Bench Height - Sliding Door · wire access through top of chassis · pass through rectangular side grommets · adjustable shelf · modular top required, see pages 136-137 · locking door not available		SSB2436MSD	24	36	19 1/4	106	12	\$842
			SSB1836MSD	18	36	19 1/4	86	10	\$776
			SSB2430MSD	24	30	19 1/4	94	10	\$792
			SSB1830MSD	18	30	19 1/4	76	8	\$735
	Bench Height - Open Shelf · wire access through top of chassis · pass through rectangular side grommets · adjustable shelf · modular top required, see pages 136-137		SSB2436MOS	24	36	19 1/4	94	12	\$594
			SSB1836MOS	18	36	19 1/4	76	10	\$535
			SSB2430MOS	24	30	19 1/4	82	10	\$553
			SSB1830MOS	18	30	19 1/4	66	8	\$501
			SSB2424MOS	24	24	19 1/4	71	8	\$513
			SSB1824MOS	18	24	19 1/4	57	7	\$469
			SSB2418MOS	24	18	19 1/4	60	7	\$474
		SSB1818MOS	18	18	19 1/4	49	5	\$438	

To Order, Specify:

- ① Model number
- ② Laminate color

② Laminate Color Options:

ALB	Alabaster	GRH	Graphite
AUT	Autumn	HGL	High Line
BLO	Blonde Echo	SHD	Shadow
BBN	Bourbon	SHE	Shea
BZW	Brazilwood	SLG	Slate Grey
BBL	Bridal Blanco	STU	Studio Teak
BRG	Brighton	TAU	Taupe
DWH	Designer White	VIN	Vintage
DOV	Dove Grey	WLH	Walnut Heights

Order Check List
page 133

Product Specifications
page 40

MODULAR BENCH HEIGHT STORAGE

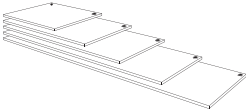
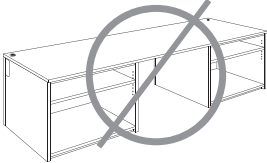
Description	① Model	D	W	H	CTN WT	CU FT	List Price
 <p>24" Deep Modular Top for Bench Height · two grommets - left and right corners · parallel grain to user side · bench cushions available, see page 212</p>	SSB24108MT	24	108	¾	63	5	\$325
	SSB24102MT	24	102	¾	59	5	\$315
	SSB2496MT	24	96	¾	55	4	\$304
 <p>· modular bench height tops NOT intended for unsupported space</p>	SSB2490MT	24	90	¾	51	4	\$293
	SSB2484MT	24	84	¾	47	4	\$282
	SSB2478MT	24	78	¾	44	4	\$272
	SSB2472MT	24	72	¾	40	4	\$263
	SSB2466MT	24	66	¾	37	3	\$250
	SSB2460MT	24	60	¾	34	3	\$240
	SSB2454MT	24	54	¾	31	3	\$230
	SSB2448MT	24	48	¾	27	3	\$220
	SSB2442MT	24	42	¾	24	3	\$208
	SSB2436MT	24	36	¾	21	2	\$199
	SSB2430MT	24	30	¾	17	2	\$184
	SSB2424MT	24	24	¾	14	2	\$175
	SSB2418MT	24	18	¾	11	1	\$164

SWISH

MODULAR BENCH HEIGHT STORAGE

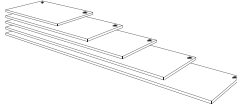
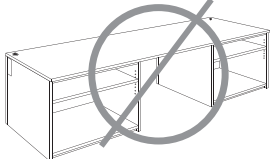
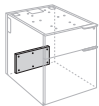
Description	① Model	D	W	H	CTN WT	CU FT	List Price
 <p>18" Deep Modular Top for Bench Height · two grommets - left and right corners · parallel grain to user side · bench cushions available, see page 213</p>  <p>· modular bench height tops NOT intended for unsupported space</p>	SSB18108MT	18	108	3/4	54	4	\$280
	SSB18102MT	18	102	3/4	50	4	\$272
	SSB1896MT	18	96	3/4	49	4	\$264
	SSB1890MT	18	90	3/4	46	3	\$256
	SSB1884MT	18	84	3/4	42	3	\$246
	SSB1878MT	18	78	3/4	39	3	\$239
	SSB1872MT	18	72	3/4	36	3	\$231
	SSB1866MT	18	66	3/4	33	3	\$222
	SSB1860MT	18	60	3/4	30	2	\$214
	SSB1854MT	18	54	3/4	27	2	\$205
	SSB1848MT	18	48	3/4	24	2	\$198
	SSB1842MT	18	42	3/4	20	2	\$189
	SSB1836MT	18	36	3/4	17	2	\$180
	SSB1830MT	18	30	3/4	14	2	\$172
	SSB1824MT	18	24	3/4	11	1	\$162
	SSB1818MT	18	18	3/4	9	1	\$154
 <p>20 lb. Counterweight · attaches to inside back panel of unit · field installed · hardware included</p> <p>10 lb. Counterweight · attaches to inside back panel of unit · field installed · hardware included</p>	SS20LB	1/2	12	11 1/4	21	1	\$184
	SS10LB	1/2	12	6	11	1	\$93

SWISH

To Order, Specify:

- ① Model number
- ② Laminate color

② Laminate Color Options:

ALB Alabaster	GRH Graphite
AUT Autumn	HGL High Line
BLO Blonde Echo	SHD Shadow
BBN Bourbon	SHE Shea
BZW Brazilwood	SLG Slate Grey
BBL Bridal Blanco	STU Studio Teak
BRG Brighton	TAU Taupe
DWH Designer White	VIN Vintage
DOV Dove Grey	WLH Walnut Heights

Order Check List
page 133

Product Specifications
page 40

WORKSURFACE SUPPORTS

	Description	Model	D	W	H	CTN WT	CU FT	List Price
	Spacer to Executive Height Storage	SSK-TOPSPACER2 · kit contains two spacers · used with executive height undersurface storage units · silver finish				1	1	\$52
	Spacer to Executive Height Storage	SSK-TOPSPACER1 · kit contains one spacer · used with executive height undersurface storage units · may be used as center support for corner worksurfaces with executive height storage units · silver finish				1	1	\$44
	Leg to Floor	SSK-LEG2-29 · kit contains two legs · silver finish				6	2	\$412
	Leg to Floor	SSK-LEG1-29 · kit contains one leg · required center support for 120° and Boomerang worksurface tops · may be used as center support for corner worksurface tops · silver finish				3	1	\$206
	Leg to Bench Height	SSK-BTD2-29 · kit contains two legs · silver finish				4	1	\$260
	Leg to Bench Height	SSK-BTD1-29 · kit contains one leg · may be used as center support for corner worksurfaces with bench height storage units · silver finish				3	1	\$131
	Bracket to Tall Storage	SSK-LBRKT-36 · typically used with 36" deep tops · mounts to tall storage unit · includes one each SSK-TOPSPACER1 for use with plenum · silver finish				3	1	\$82
	Bracket to Tall Storage	SSK-LBRKT-30 · typically used with 30" deep tops · mounts to tall storage unit · includes one each of SSK-TOPSPACER1 for use with plenum · silver finish				3	1	\$77
	Bracket to Tall Storage	SSK-LBRKT-24 · typically used with 24" deep tops · mounts to tall storage unit · includes one each of SSK-TOPSPACER1 for use with plenum · silver finish				2	1	\$71
	Bracket to Tall Storage	SSK-LBRKT-18 · typically used with 18" deep tops · mounts to tall storage unit · includes one each of SSK-TOPSPACER1 for use with plenum · silver finish				2	1	\$67

Tall Storage Order Check List:

Specify:

- 1. Model number
- 2. Laminate color

Example:

SS2418-54BBFSSTR | **BZW**
 (model #) | (laminate color)

1. Model number

2. Laminate Color Options:

ALB	Alabaster	GRH	Graphite
AUT	Autumn	HGL	High Line
BLO	Blonde Echo	SHD	Shadow
BBN	Bourbon	SHE	Shea
BZW	Brazilwood	SLG	Slate Grey
BBL	Bridal Blanco	STU	Studio Teak
BRG	Brighton	TAU	Taupe
DWH	Designer White	VIN	Vintage
DOV	Dove Grey	WLH	Walnut Heights

Pull Style and Finish:



Flat (Alloy finish)

NOTE: All drawers are predrilled for easy field installation. Pulls for drawers can be installed in the left, center or right locations. All doors have a touch latch mechanism.

Counterweights:

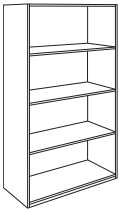
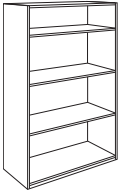
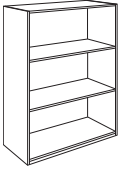

In order to pass stability tests some Tall Storage units will require a field installed 20 lb. 1/2" thick counterweight to be mounted on the inside of the back panel of the unit. The counterweight will need to be ordered separately, see page 148. As an alternative to the counterweight the unit can be secured to the wall or floor.

TALL STORAGE

Description	① Model	D	W	H	CTN WT	CU FT	List Price
Bookcase 	SS1536-60BC · three adjustable shelves	15	36	60	126	24	\$796
	SS1530-60BC · three adjustable shelves	15	30	60	118	20	\$734
	SS1518-60BC · three adjustable shelves	15	18	60	71	13	\$635
Bookcase 	SS1536-54BC · three adjustable shelves	15	36	54	115	21	\$774
	SS1530-54BC · three adjustable shelves	15	30	54	108	18	\$714
	SS1518-54BC · three adjustable shelves	15	18	54	64	12	\$618
Bookcase 	SS1536-45BC · two adjustable shelves	15	36	45	96	18	\$720
	SS1530-45BC · two adjustable shelves	15	30	45	90	15	\$662
	SS1518-45BC · two adjustable shelves	15	18	45	53	10	\$571

SWISH

TALL STORAGE

		Description	① Model	D	W	H	CTN WT	CU FT	List Price	
 Right	 Left	Storage Cabinet · two adjustable shelves · pass through rectangular side grommets · non-locking door standard; locking door available, specify and add \$105 list · box/box/file · pedestal front locking · field installed pulls	Right Left	SS2418-60BBFTR SS2418-60BBFTL	24 24	18 18	60 60	178 178	19 19	\$1,512 \$1,512
		Storage Cabinet · one adjustable shelf · pass through rectangular side grommets · non-locking door standard; locking door available, specify and add \$105 list · box/box/file · pedestal front locking · field installed pulls	Right Left	SS2418-54BBFTR SS2418-54BBFTL	24 24	18 18	54 54	168 168	17 17	\$1,467 \$1,467
		Storage Cabinet · two adjustable shelves · pass through rectangular side grommets · non-locking door standard; locking door available, specify and add \$105 list · box/box/file · pedestal front locking · field installed pulls	Right Left	SS2418-45BBFTR SS2418-45BBFTL	24 24	18 18	45 45	149 149	15 15	\$1,380 \$1,380
		Storage Cabinet · two adjustable shelves · pass through rectangular side grommets · non-locking door standard; locking door available, specify and add \$105 list · box/box/file · pedestal front locking · field installed pulls	Right Left	SS1818-60BBFTR SS1818-60BBFTL	18 18	18 18	60 60	153 153	15 15	\$1,396 \$1,396
		Storage Cabinet · one adjustable shelf · pass through rectangular side grommets · non-locking door standard; locking door available, specify and add \$105 list · box/box/file · pedestal front locking · field installed pulls	Right Left	SS1818-54BBFTR SS1818-54BBFTL	18 18	18 18	54 54	144 144	13 13	\$1,357 \$1,357
		Storage Cabinet · one adjustable shelf · pass through rectangular side grommets · non-locking door standard; locking door available, specify and add \$105 list · box/box/file · pedestal front locking · field installed pulls	Right Left	SS1818-45BBFTR SS1818-45BBFTL	18 18	18 18	45 45	129 129	11 11	\$1,289 \$1,289

SWISH

To Order, Specify:

- ① Model number
- ② Laminate color



② Laminate Color Options:

ALB Alabaster	GRH Graphite
AUT Autumn	HGL High Line
BLO Blonde Echo	SHD Shadow
BBN Bourbon	SHE Shea
BZW Brazilwood	SLG Slate Grey
BBL Bridal Blanco	STU Studio Teak
BRG Brighton	TAU Taupe
DWH Designer White	VIN Vintage
DOV Dove Grey	WLH Walnut Heights

Order Check List
page 139

Product Specifications
page 40

TALL STORAGE

Description		① Model	D	W	H	CTN WT	CU FT	List Price
 Right	Storage Cabinet · two adjustable shelves · pass through rectangular side grommets · non-locking door standard; locking door available, specify and add \$105 list · file/file · pedestal front locking · field installed pulls	Right SS2418-60FFTR	24	18	60	179	19	\$1,482
		Left SS2418-60FFTL	24	18	60	179	19	\$1,482
 Left	Storage Cabinet · one adjustable shelf · pass through rectangular side grommets · non-locking door standard; locking door available, specify and add \$105 list · file/file · pedestal front locking · field installed pulls	Right SS2418-54FFTR	24	18	54	169	17	\$1,439
		Left SS2418-54FFTL	24	18	54	169	17	\$1,439
	Storage Cabinet · one adjustable shelf · pass through rectangular side grommets · non-locking door standard; locking door available, specify and add \$105 list · file/file · pedestal front locking · field installed pulls	Right SS2418-45FFTR	24	18	45	150	15	\$1,353
		Left SS2418-45FFTL	24	18	45	150	15	\$1,353
	Storage Cabinet · two adjustable shelves · pass through rectangular side grommets · non-locking door standard; locking door available, specify and add \$105 list · file/file · pedestal front locking · one 20 lb. counterweight required, see page 148 for counterweight · unit can be secured to wall or floor as alternative to counterweight · field installed pulls	Right SS1818-60FFTR	18	18	60	154	15	\$1,370
		Left SS1818-60FFTL	18	18	60	154	15	\$1,370
	Storage Cabinet · one adjustable shelf · pass through rectangular side grommets · non-locking door standard; locking door available, specify and add \$105 list · file/file · pedestal front locking · one 20 lb. counterweight required, see page 148 for counterweight · unit can be secured to wall or floor as alternative to counterweight · field installed pulls	Right SS1818-54FFTR	18	18	54	145	13	\$1,332
		Left SS1818-54FFTL	18	18	54	145	13	\$1,332
		Right SS1818-45FFTR	18	18	45	130	11	\$1,262
		Left SS1818-45FFTL	18	18	45	130	11	\$1,262

SWISH

TALL STORAGE



Description	① Model	D	W	H	CTN WT	CU FT	List Price
Storage Cabinet · two adjustable shelves · pass through rectangular side grommets · non-locking doors standard; locking doors available, specify and add \$105 list · box/box/lateral file · pedestal front locking · field installed pulls	SS2436-60BBFT	24	36	60	278	36	\$2,072
Storage Cabinet · one adjustable shelf · pass through rectangular side grommets	SS2436-54BBFT	24	36	54	261	33	\$1,986
· non-locking doors standard; locking doors available, specify and add \$105 list · box/box/lateral file · pedestal front locking · field installed pulls	SS2436-45BBFT	24	36	45	227	27	\$1,815
Storage Cabinet · two adjustable shelves · pass through rectangular side grommets · non-locking doors standard; locking doors available, specify and add \$105 list · box/box/lateral file · pedestal front locking · field installed pulls	SS2430-60BBFT	24	30	60	251	30	\$1,947
Storage Cabinet · one adjustable shelf · pass through rectangular side grommets	SS2430-54BBFT	24	30	54	236	27	\$1,863
· non-locking doors standard; locking doors available, specify and add \$105 list · box/box/lateral file · pedestal front locking · field installed pulls	SS2430-45BBFT	24	30	45	207	23	\$1,697
Storage Cabinet · two adjustable shelves · pass through rectangular side grommets · non-locking doors standard; locking doors available, specify and add \$105 list · box/box/lateral file · pedestal front locking · one 20 lb. counterweight required, see page 148 for counterweight · unit can be secured to wall or floor as alternative to counterweight · field installed pulls	SS1836-60BBFT	18	36	60	235	28	\$1,902
Storage Cabinet · one adjustable shelf · pass through rectangular side grommets	SS1836-54BBFT	18	36	54	221	25	\$1,831
· non-locking doors standard; locking doors available, specify and add \$105 list · box/box/lateral file · pedestal front locking · one 20 lb. counterweight required, see page 148 for counterweight · unit can be secured to wall or floor as alternative to counterweight · field installed pulls	SS1836-45BBFT	18	36	45	194	21	\$1,679

SWISH

To Order, Specify:

- ① Model number
- ② Laminate color

② Laminate Color Options:

ALB Alabaster	GRH Graphite
AUT Autumn	HGL High Line
BLO Blonde Echo	SHD Shadow
BBN Bourbon	SHE Shea
BZW Brazilwood	SLG Slate Grey
BBL Bridal Blanco	STU Studio Teak
BRG Brighton	TAU Taupe
DWH Designer White	VIN Vintage
DOV Dove Grey	WLH Walnut Heights





Order Check List
page 139

Product Specifications
page 40

TALL STORAGE

	Description	① Model	D	W	H	CTN WT	CU FT	List Price
	Storage Cabinet · two adjustable shelves · pass through rectangular side grommets · non-locking doors standard; locking doors available, specify and add \$105 list · box/box/lateral file · pedestal front locking · one 20 lb. counterweight required, see page 148 for counterweight · unit can be secured to wall or floor as alternative to counterweight · field installed pulls	SS1830-60BBFT	18	30	60	214	23	\$1,799
	Storage Cabinet · one adjustable shelf · pass through rectangular side grommets · non-locking doors standard; locking doors available, specify and add \$105 list · box/box/lateral file · pedestal front locking · one 20 lb. counterweight required, see page 148 for counterweight · unit can be secured to wall or floor as alternative to counterweight · field installed pulls	SS1830-54BBFT	18	30	54	201	21	\$1,731
	· non-locking doors standard; locking doors available, specify and add \$105 list · box/box/lateral file · pedestal front locking · one 20 lb. counterweight required, see page 148 for counterweight · unit can be secured to wall or floor as alternative to counterweight · field installed pulls	SS1830-45BBFT	18	30	45	177	18	\$1,584
	Storage Cabinet · two adjustable shelves · pass through rectangular side grommets · non-locking doors standard; locking doors available, specify and add \$105 list · lateral file · pedestal front locking · field installed pulls	SS2436-60FFT	24	36	60	277	36	\$2,085
	Storage Cabinet · one adjustable shelf · pass through rectangular side grommets · non-locking doors standard; locking doors available, specify and add \$105 list · lateral file · pedestal front locking · field installed pulls	SS2436-54FFT	24	36	54	260	33	\$1,999
	· non-locking doors standard; locking doors available, specify and add \$105 list · lateral file · pedestal front locking · field installed pulls	SS2436-45FFT	24	36	45	226	27	\$1,829
	Storage Cabinet · two adjustable shelves · pass through rectangular side grommets · non-locking doors standard; locking doors available, specify and add \$105 list · lateral file · pedestal front locking · field installed pulls	SS2430-60FFT	24	30	60	250	30	\$1,962
	Storage Cabinet · one adjustable shelf · pass through rectangular side grommets · non-locking doors standard; locking doors available, specify and add \$105 list · lateral file · pedestal front locking · field installed pulls	SS2430-54FFT	24	30	54	235	27	\$1,878
	· non-locking doors standard; locking doors available, specify and add \$105 list · lateral file · pedestal front locking · field installed pulls	SS2430-45FFT	24	30	45	206	23	\$1,712

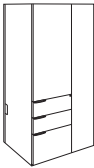
TALL STORAGE

		Description	① Model	D	W	H	CTN WT	CU FT	List Price	
 Right	 Left	Storage Cabinet with Side Access · two adjustable shelves · pass through rectangular side grommets · box/box/file · pedestal front locking · field installed pulls	Right	SS2418-60BBFSSTR 24	18	18	60	164	19	\$1,399
			Left	SS2418-60BBFSSTL 24	18	18	60	164	19	\$1,399
		Storage Cabinet with Side Access · one adjustable shelf · pass through rectangular side grommets · box/box/file · pedestal front locking · field installed pulls	Right	SS2418-54BBFSSTR 24	18	18	54	157	17	\$1,364
			Left	SS2418-54BBFSSTL 24	18	18	54	157	17	\$1,364
		Storage Cabinet with Side Access · one adjustable shelf · pass through rectangular side grommets · box/box/file · pedestal front locking · field installed pulls	Right	SS2418-45BBFSSTR 24	18	18	45	139	15	\$1,283
			Left	SS2418-45BBFSSTL 24	18	18	45	139	15	\$1,283
		Storage Cabinet with Side Access · two adjustable shelves · pass through rectangular side grommets · box/box/file · pedestal front locking · one 20 lb. counterweight required, see page 148 for counterweight · unit can be secured to wall or floor as alternative to counterweight · field installed pulls	Right	SS1818-60BBFSSTR 18	18	18	60	143	15	\$1,300
			Left	SS1818-60BBFSSTL 18	18	18	60	143	15	\$1,300
		Storage Cabinet with Side Access · one adjustable shelf · pass through rectangular side grommets · box/box/file · pedestal front locking · one 20 lb. counterweight required, see page 148 for counterweight · unit can be secured to wall or floor as alternative to counterweight · field installed pulls	Right	SS1818-54BBFSSTR 18	18	18	54	136	13	\$1,271
			Left	SS1818-54BBFSSTL 18	18	18	54	136	13	\$1,271
		Storage Cabinet with Side Access · one adjustable shelf · pass through rectangular side grommets · box/box/file · pedestal front locking · one 20 lb. counterweight required, see page 148 for counterweight · unit can be secured to wall or floor as alternative to counterweight · field installed pulls	Right	SS1818-45BBFSSTR 18	18	18	45	121	11	\$1,200
			Left	SS1818-45BBFSSTL 18	18	18	45	121	11	\$1,200
 Right	 Left	Storage Wardrobe · chrome hanging bar · two adjustable shelves · pass through rectangular side grommets · non-locking doors standard; locking doors available, specify and add \$210 list · box/box/file · pedestal front locking · field installed pulls	Right	SS2430-60BBFWR 24	30	30	60	270	28	\$1,947
			Left	SS2430-60BBFWL 24	30	30	60	270	28	\$1,947
		Storage Wardrobe · chrome hanging bar · one adjustable shelf · pass through rectangular side grommets · non-locking doors standard; locking doors available, specify and add \$210 list · box/box/file · pedestal front locking · field installed pulls	Right	SS2430-54BBFWR 24	30	30	54	255	25	\$1,860
			Left	SS2430-54BBFWL 24	30	30	54	255	25	\$1,860
		Storage Wardrobe · chrome hanging bar · one adjustable shelf · pass through rectangular side grommets · non-locking doors standard; locking doors available, specify and add \$210 list · box/box/file · pedestal front locking · field installed pulls	Right	SS2430-45BBFWR 24	30	30	45	226	21	\$1,688
			Left	SS2430-45BBFWL 24	30	30	45	226	21	\$1,688

SWISH

To Order, Specify:

- ① Model number
- ② Laminate color



② Laminate Color Options:

ALB	Alabaster	GRH	Graphite
AUT	Autumn	HGL	High Line
BLO	Blonde Echo	SHD	Shadow
BBN	Bourbon	SHE	Shea
BZW	Brazilwood	SLG	Slate Grey
BBL	Bridal Blanco	STU	Studio Teak
BRG	Brighton	TAU	Taupe
DWH	Designer White	VIN	Vintage
DOV	Dove Grey	WLH	Walnut Heights

Order Check List
page 139

Product Specifications
page 40

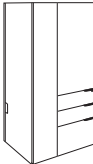
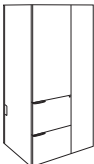
TALL STORAGE

Description		① Model	D	W	H	CTN WT	CU FT	List Price
 Right	Storage Wardrobe · coat hook · two adjustable shelves · pass through rectangular side grommets · non-locking doors standard; locking doors available, specify and add \$210 list · box/box/file · pedestal front locking · field installed pulls	Right Left	18 18	30 30	60 60	230 230	21 21	\$1,793 \$1,793
	Storage Wardrobe · coat hook · one adjustable shelf · pass through rectangular side grommets · non-locking doors standard; locking doors available, specify and add \$210 list · box/box/file · pedestal front locking · field installed pulls	Right Left	18 18	30 30	54 54	217 217	19 19	\$1,722 \$1,722
 Left	Storage Wardrobe · coat hook · one adjustable shelf · pass through rectangular side grommets · non-locking doors standard; locking doors available, specify and add \$210 list · box/box/file · pedestal front locking · field installed pulls	Right Left	18 18	30 30	45 45	193 193	16 16	\$1,572 \$1,572
	Storage Wardrobe · chrome hanging bar · two adjustable shelves · pass through rectangular side grommets · non-locking doors standard; locking doors available, specify and add \$210 list · file/file · pedestal front locking · field installed pulls	Right Left	24 24	30 30	60 60	271 271	28 28	\$1,920 \$1,920
 Right	Storage Wardrobe · chrome hanging bar · one adjustable shelf · pass through rectangular side grommets · non-locking doors standard; locking doors available, specify and add \$210 list · file/file · pedestal front locking · field installed pulls	Right Left	24 24	30 30	54 54	256 256	25 25	\$1,832 \$1,832
	Storage Wardrobe · chrome hanging bar · two adjustable shelves · pass through rectangular side grommets · non-locking doors standard; locking doors available, specify and add \$210 list · file/file · pedestal front locking · field installed pulls	Right Left	24 24	30 30	45 45	227 227	21 21	\$1,661 \$1,661
 Left	Storage Wardrobe · coat hook · two adjustable shelves · pass through rectangular side grommets · non-locking doors standard; locking doors available, specify and add \$210 list · file/file · pedestal front locking · field installed pulls	Right Left	18 18	30 30	60 60	230 230	21 21	\$1,767 \$1,767
	Storage Wardrobe · coat hook · one adjustable shelf · pass through rectangular side grommets · non-locking doors standard; locking doors available, specify and add \$210 list · file/file · pedestal front locking · field installed pulls	Right Left	18 18	30 30	54 54	217 217	19 19	\$1,696 \$1,696
 Right	Storage Wardrobe · coat hook · one adjustable shelf · pass through rectangular side grommets · non-locking doors standard; locking doors available, specify and add \$210 list · file/file · pedestal front locking · field installed pulls	Right Left	18 18	30 30	45 45	193 193	16 16	\$1,545 \$1,545
	Storage Wardrobe · coat hook · one adjustable shelf · pass through rectangular side grommets · non-locking doors standard; locking doors available, specify and add \$210 list · file/file · pedestal front locking · field installed pulls	Right Left	18 18	30 30	45 45	193 193	16 16	\$1,545 \$1,545

SWISH

TALL STORAGE

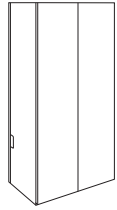

Description	① Model	D	W	H	CTN WT	CU FT	List Price
Double Door Storage Cabinet · three adjustable shelves · pass through rectangular side grommets · locking doors not available	SS2436-60HD	24	36	60	235	36	\$1,589
	SS2436-54HD	24	36	54	218	33	\$1,501
Double Door Storage Cabinet · two adjustable shelves · pass through rectangular side grommets · locking doors not available	SS2436-45HD	24	36	45	184	27	\$1,329
Double Door Storage Cabinet · three adjustable shelves · pass through rectangular side grommets · locking doors not available	SS2430-60HD	24	30	60	213	30	\$1,493
	SS2430-54HD	24	30	54	198	27	\$1,409
Double Door Storage Cabinet · two adjustable shelves · pass through rectangular side grommets · locking doors not available	SS2430-45HD	24	30	45	169	23	\$1,241
Double Door Storage Cabinet · three adjustable shelves · pass through rectangular side grommets · locking doors not available	SS1836-60HD	18	36	60	196	28	\$1,426
	SS1836-54HD	18	36	54	182	25	\$1,355
Double Door Storage Cabinet · two adjustable shelves · pass through rectangular side grommets · locking doors not available	SS1836-45HD	18	36	45	155	21	\$1,205
Double Door Storage Cabinet · three adjustable shelves · pass through rectangular side grommets · locking doors not available	SS1830-60HD	18	30	60	180	23	\$1,356
	SS1830-54HD	18	30	54	167	21	\$1,288
Double Door Storage Cabinet · two adjustable shelves · pass through rectangular side grommets · locking doors not available	SS1830-45HD	18	30	45	143	18	\$1,143

SWISH

To Order, Specify:

- ① Model number
- ② Laminate color



② Laminate Color Options:

ALB Alabaster	GRH Graphite
AUT Autumn	HGL High Line
BLO Blonde Echo	SHD Shadow
BBN Bourbon	SHE Shea
BZW Brazilwood	SLG Slate Grey
BBL Bridal Blanco	STU Studio Teak
BRG Brighton	TAU Taupe
DWH Designer White	VIN Vintage
DOV Dove Grey	WLH Walnut Heights

Order Check List
page 139

Product Specifications
page 40

TALL STORAGE

		Description	① Model	D	W	H	CTN WT	CU FT	List Price	
 Right	 Left	Single Door Storage Cabinet · three adjustable shelves · pass through rectangular side grommets · non-locking doors standard; locking doors available, specify and add \$105 list	Right Left	SS2418-60HR SS2418-60HL	24 24	18 18	60 60	152 152	19 19	\$1,166 \$1,166
		Single Door Storage Cabinet · two adjustable shelves · pass through rectangular side grommets · non-locking doors standard; locking doors available, specify and add \$105 list	Right Left	SS2418-54HR SS2418-54HL	24 24	18 18	54 54	141 141	17 17	\$1,122 \$1,122
		Single Door Storage Cabinet · three adjustable shelves · pass through rectangular side grommets · non-locking doors standard; locking doors available, specify and add \$105 list	Right Left	SS2418-45HR SS2418-45HL	24 24	18 18	45 45	122 122	15 15	\$1,033 \$1,033
		Single Door Storage Cabinet · three adjustable shelves · pass through rectangular side grommets · non-locking doors standard; locking doors available, specify and add \$105 list	Right Left	SS1818-60HR SS1818-60HL	18 18	18 18	60 60	126 126	15 15	\$1,057 \$1,057
		Single Door Storage Cabinet · two adjustable shelves · pass through rectangular side grommets · non-locking doors standard; locking doors available, specify and add \$105 list	Right Left	SS1818-54HR SS1818-54HL	18 18	18 18	54 54	118 118	13 13	\$1,019 \$1,019
		Single Door Storage Cabinet · two adjustable shelves · pass through rectangular side grommets · non-locking doors standard; locking doors available, specify and add \$105 list	Right Left	SS1818-45HR SS1818-45HL	18 18	18 18	45 45	103 103	11 11	\$949 \$949
		20 lb. Counterweight · attaches to inside back panel of unit · field installed · hardware included		SS20LB	1/2	12	11 1/4	21	1	\$184
		10 lb. Counterweight · attaches to inside back panel of unit · field installed · hardware included		SS10LB	1/2	12	6	11	1	\$93

To Order, Specify:

- ① Model number
- ② Laminate color

② Laminate Color Options:

ALB Alabaster	GRH Graphite
AUT Autumn	HGL High Line
BLO Blonde Echo	SHD Shadow
BBN Bourbon	SHE Shea
BZW Brazilwood	SLG Slate Grey
BBL Bridal Blanco	STU Studio Teak
BRG Brighton	TAU Taupe
DWH Designer White	VIN Vintage
DOV Dove Grey	WLH Walnut Heights

Order Check List

page 139

Product Specifications

page 40

Above Surface Storage Order Check List:

Specify:

- 1. Model number
- 2. Laminate color

Example:

SS2172GHD | **DWH**
 (model #) | (laminate color)

1. Model number

2. Laminate Color Options:

- | | |
|--------------------|--------------------|
| ALB Alabaster | GRH Graphite |
| AUT Autumn | HGL High Line |
| BLO Blonde Echo | SHD Shadow |
| BBN Bourbon | SHE Shea |
| BZW Brazilwood | SLG Slate Grey |
| BBL Bridal Blanco | STU Studio Teak |
| BRG Brighton | TAU Taupe |
| DWH Designer White | VIN Vintage |
| DOV Dove Grey | WLH Walnut Heights |

ABOVE SURFACE STORAGE
Leg Supported

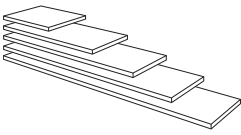

Description	① Model	D	W	H	CTN WT	CU FT	List Price
Transaction Top · support options must be purchased separately, see pages 158-159 for options	SST1584TRAN	15	84	1 3/16	46	5	\$674
	SST1578TRAN	15	78	1 3/16	43	5	\$619
	SST1572TRAN	15	72	1 3/16	40	5	\$594
	SST1566TRAN	15	66	1 3/16	37	4	\$562
	SST1560TRAN	15	60	1 3/16	34	4	\$533
	SST1554TRAN	15	54	1 3/16	31	4	\$507
	SST1548TRAN	15	48	1 3/16	28	3	\$475
	SST1542TRAN	15	42	1 3/16	25	3	\$406
	SST1536TRAN	15	36	1 3/16	22	3	\$382
	SST1530TRAN	15	30	1 3/16	19	2	\$344

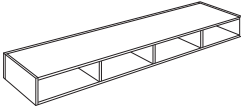

Horizontal Cubby Organizer · 4 compartments · support options must be purchased separately, see pages 158-159 for options · cannot be wall mounted	SS0684CU	15	84	6	77	7	\$698
	SS0678CU	15	78	6	72	7	\$679
	SS0672CU	15	72	6	68	6	\$655
	SS0666CU	15	66	6	64	6	\$627
	SS0660CU	15	60	6	59	5	\$612
	SS0654CU	15	54	6	52	5	\$575
	SS0648CU	15	48	6	48	4	\$554

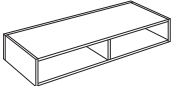

Horizontal Cubby Organizer · 2 compartments · support options must be purchased separately, see pages 158-159 for options · cannot be wall mounted	SS0642CU	15	42	6	43	4	\$532
	SS0636CU	15	36	6	39	3	\$508
	SS0630CU	15	30	6	35	3	\$487

ABOVE SURFACE STORAGE
Leg Supported

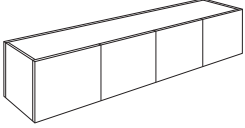
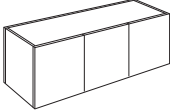
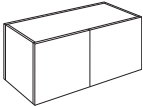
	Description	① Model	D	W	H	CTN WT	CU FT	List Price
	Storage Overhead Cabinet	SS1584HD	15	84	15	129	15	\$986
	· support options must be purchased separately, see pages 158 and 160 for options	SS1578HD	15	78	15	121	14	\$954
	· non-locking doors standard; locking doors available, specify and add \$210 list	SS1572HD	15	72	15	114	13	\$920
		SS1566HD	15	66	15	107	12	\$888
		SS1560HD	15	60	15	99	11	\$857
		SS1554HD	15	54	15	92	10	\$822
	Storage Overhead Cabinet	Right SS1548HDR	15	48	15	85	9	\$770
	· support options must be purchased separately, see pages 158 and 160 for options	Left SS1548HDL	15	48	15	85	9	\$770
	· non-locking doors standard; locking doors available, specify and add \$210 list	Right SS1542HDR	15	42	15	77	8	\$737
	· right door configuration - 1 door hinges left and 2 doors hinge right	Left SS1542HDL	15	42	15	77	8	\$737
	· left door configuration - 1 door hinges right and 2 doors hinge left							
	Storage Overhead Cabinet	SS1536HD	15	36	15	66	7	\$664
	· support options must be purchased separately, see pages 158 and 160 for options	SS1530HD	15	30	15	59	6	\$635
	· non-locking doors standard; locking doors available, specify and add \$105 list							

SWISH

To Order, Specify:

- ① Model number
- ② Laminate color

② Laminate Color Options:

ALB Alabaster	GRH Graphite
AUT Autumn	HGL High Line
BLO Blonde Echo	SHD Shadow
BBN Bourbon	SHE Shea
BZW Brazilwood	SLG Slate Grey
BBL Bridal Blanco	STU Studio Teak
BRG Brighton	TAU Taupe
DWH Designer White	VIN Vintage
DOV Dove Grey	WLH Walnut Heights

Order Check List
page 149

Product Specifications
page 40

ABOVE SURFACE STORAGE
Leg Supported

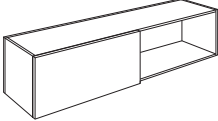

Description	① Model	D	W	H	CTN WT	CU FT	List Price
Storage Overhead Cabinet Sliding Door · support options must be purchased separately, see pages 158 and 160 for options · locking door not available	SS1584SD	15	84	15	113	15	\$1,132
	SS1578SD	15	78	15	107	14	\$1,104
	SS1572SD	15	72	15	101	13	\$1,071
	SS1566SD	15	66	15	94	12	\$1,000
	SS1560SD	15	60	15	88	11	\$964
	SS1554SD	15	54	15	81	10	\$928
	SS1548SD	15	48	15	75	9	\$890
	SS1542SD	15	42	15	69	8	\$852
	SS1536SD	15	36	15	62	7	\$812
	SS1530SD	15	30	15	56	6	\$785

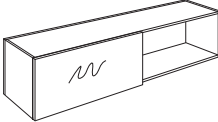

Storage Overhead Cabinet Sliding Markerboard Door · markerboard doors feature an HPL laminate and a silver PVC edge banding · support options must be purchased separately, see pages 158 and 160 for options · locking door not available	SS1584DESD	15	84	15	113	15	\$1,293
	SS1578DESD	15	78	15	107	14	\$1,267
	SS1572DESD	15	72	15	101	13	\$1,234
	SS1566DESD	15	66	15	94	12	\$1,163
	SS1560DESD	15	60	15	88	11	\$1,127
	SS1554DESD	15	54	15	81	10	\$1,090
	SS1548DESD	15	48	15	75	9	\$1,053
	SS1542DESD	15	42	15	69	8	\$1,015
	SS1536DESD	15	36	15	62	7	\$974
	SS1530DESD	15	30	15	56	6	\$947

ABOVE SURFACE STORAGE
Leg Supported

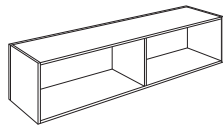

Description

① Model

D

W

H

CTN
WT

CU
FT

List Price

Storage Open Overhead Cabinet
· support options must be purchased separately,
see pages 158 and 160 for options

SS158400	15	84	15	102	15	\$766
SS157800	15	78	15	96	14	\$740
SS157200	15	72	15	91	13	\$712
SS156600	15	66	15	85	12	\$688
SS156000	15	60	15	80	11	\$662
SS155400	15	54	15	74	10	\$638
SS154800	15	48	15	69	9	\$613
SS154200	15	42	15	63	8	\$586
SS153600	15	36	15	54	7	\$545
SS153000	15	30	15	48	6	\$520

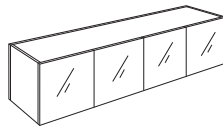

Glass Storage Overhead Cabinet
· white back painted glass
· aluminum frame doors
· support options must be purchased separately,
see pages 158 and 160 for options
· locking doors not available

SS1584GHD	15	84	15	129	15	\$1,658
SS1578GHD	15	78	15	121	14	\$1,592
SS1572GHD	15	72	15	114	13	\$1,539
SS1566GHD	15	66	15	107	12	\$1,496
SS1560GHD	15	60	15	99	11	\$1,435
SS1554GHD	15	54	15	92	10	\$1,394

To Order, Specify:

- ① Model number
- ② Laminate color

② Laminate Color Options:

ALB	Alabaster	GRH	Graphite
AUT	Autumn	HGL	High Line
BLO	Blonde Echo	SHD	Shadow
BBN	Bourbon	SHE	Shea
BZW	Brazilwood	SLG	Slate Grey
BBL	Bridal Blanco	STU	Studio Teak
BRG	Brighton	TAU	Taupe
DWH	Designer White	VIN	Vintage
DOV	Dove Grey	WLH	Walnut Heights

Order Check List
page 149

Product Specifications
page 40

ABOVE SURFACE STORAGE
Leg Supported

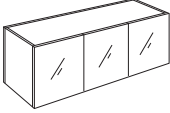
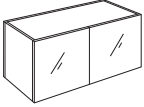
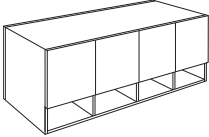
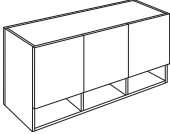
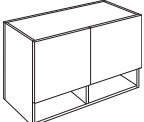
	Description	① Model	D	W	H	CTN WT	CU FT	List Price	
	Glass Storage Overhead Cabinet	Right	SS1548GHDR	15	48	15	85	9	\$1,213
	· white back painted glass	Left	SS1548GHDL	15	48	15	85	9	\$1,213
	· aluminum frame doors								
	· support options must be purchased separately, see pages 158 and 160 for options	Right	SS1542GHDR	15	42	15	77	8	\$1,162
	· locking doors not available	Left	SS1542GHDL	15	42	15	77	8	\$1,162
	· right door configuration - 1 door hinges left and 2 doors hinge right								
	· left door configuration - 1 door hinges right and 2 doors hinge left								
	Glass Storage Overhead Cabinet		SS1536GHD	15	36	15	66	7	\$974
	· white back painted glass								
	· aluminum frame doors		SS1530GHD	15	30	15	59	6	\$922
	· support options must be purchased separately, see pages 158 and 160 for options								
	· locking doors not available								
	Storage Overhead Cabinet with Cubby Below		SS2184HD	15	84	21	172	20	\$1,168
	· support options must be purchased separately, see pages 158 and 160 for options		SS2178HD	15	78	21	162	19	\$1,128
	· non-locking doors standard; locking doors available, specify and add \$210 list		SS2172HD	15	72	21	152	17	\$1,086
		SS2166HD	15	66	21	143	16	\$1,047	
		SS2160HD	15	60	21	133	15	\$1,006	
		SS2154HD	15	54	21	120	13	\$957	
	Storage Overhead Cabinet with Cubby Below	Right	SS2148HDR	15	48	21	110	12	\$892
		Left	SS2148HDL	15	48	21	110	12	\$892
	· support options must be purchased separately, see pages 158 and 160 for options								
	· non-locking doors standard; locking doors available, specify and add \$210 list	Right	SS2142HDR	15	42	21	100	10	\$842
	· right door configuration - 1 door hinges left and 2 doors hinge right	Left	SS2142HDL	15	42	21	100	10	\$842
	· left door configuration - 1 door hinges right and 2 doors hinge left								
	Storage Overhead Cabinet with Cubby Below		SS2136HD	15	36	21	86	9	\$771
	· support options must be purchased separately, see pages 158 and 160 for options		SS2130HD	15	30	21	76	9	\$732
	· non-locking doors standard; locking doors available, specify and add \$105 list								

ABOVE SURFACE STORAGE
Leg Supported

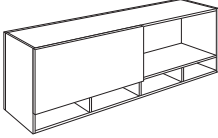
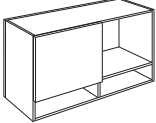
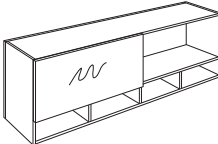
Description	① Model	D	W	H	CTN WT	CU FT	List Price
 <p>Storage Overhead Cabinet Sliding Door with Cubby Below · support options must be purchased separately, see pages 158 and 160 for options · locking door not available</p>	SS2184SD	15	84	21	159	20	\$1,305
	SS2178SD	15	78	21	150	19	\$1,270
	SS2172SD	15	72	21	141	17	\$1,230
	SS2166SD	15	66	21	132	16	\$1,122
	SS2160SD	15	60	21	123	15	\$1,073
	SS2154SD	15	54	21	111	13	\$1,017
	SS2148SD	15	48	21	102	12	\$971
 <p>Storage Overhead Cabinet Sliding Door with Cubby Below · support options must be purchased separately, see pages 158 and 160 for options · locking door not available</p>	SS2142SD	15	42	21	93	10	\$923
	SS2136SD	15	36	21	84	9	\$878
	SS2130SD	15	30	21	75	8	\$839
 <p>Storage Overhead Cabinet Sliding Markerboard Door with Cubby Below · markerboard doors feature an HPL laminate and a silver PVC edge banding · support options must be purchased separately, see pages 158 and 160 for options · locking door not available</p>	SS2184DESD	15	84	21	159	20	\$1,465
	SS2178DESD	15	78	21	150	19	\$1,431
	SS2172DESD	15	72	21	141	17	\$1,391
	SS2166DESD	15	66	21	132	16	\$1,283
	SS2160DESD	15	60	21	123	15	\$1,235
	SS2154DESD	15	54	21	111	13	\$1,178
	SS2148DESD	15	48	21	102	12	\$1,132
	SS2142DESD	15	42	21	93	10	\$1,086
	SS2136DESD	15	36	21	84	9	\$1,039
SS2130DESD	15	30	21	75	8	\$1,000	

SWISH

To Order, Specify:

- ① Model number
- ② Laminate color

② Laminate Color Options:

ALB	Alabaster	GRH	Graphite
AUT	Autumn	HGL	High Line
BLO	Blonde Echo	SHD	Shadow
BBN	Bourbon	SHE	Shea
BZW	Brazilwood	SLG	Slate Grey
BBL	Bridal Blanco	STU	Studio Teak
BRG	Brighton	TAU	Taupe
DWH	Designer White	VIN	Vintage
DOV	Dove Grey	WLH	Walnut Heights

Order Check List
page 149

Product Specifications
page 40

ABOVE SURFACE STORAGE
Leg Supported

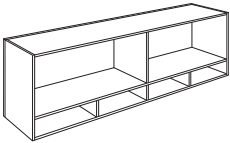
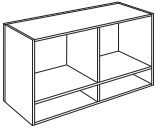
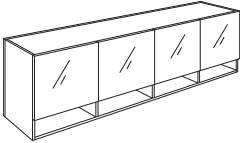
	Description	① Model	D	W	H	CTN WT	CU FT	List Price
	Storage Open Overhead Cabinet with Cubby Below · support options must be purchased separately, see pages 158 and 160 for options	SS218400	15	84	21	145	20	\$933
		SS217800	15	78	21	137	19	\$900
		SS217200	15	72	21	129	17	\$864
		SS216600	15	66	21	121	16	\$831
		SS216000	15	60	21	113	15	\$798
		SS215400	15	54	21	102	13	\$754
	Storage Open Overhead Cabinet with Cubby Below · support options must be purchased separately, see pages 158 and 160 for options	SS214800	15	48	21	94	12	\$723
		SS214200	15	42	21	86	10	\$687
		SS213600	15	36	21	74	9	\$638
		SS213000	15	30	21	66	8	\$604
	Glass Storage Overhead Cabinet with Cubby Below · white back painted glass · aluminum frame doors · support options must be purchased separately, see pages 158 and 160 for options · locking doors not available	SS2184GHD	15	84	21	172	20	\$1,795
		SS2178GHD	15	78	21	162	19	\$1,720
		SS2172GHD	15	72	21	152	17	\$1,658
		SS2166GHD	15	66	21	143	16	\$1,608
		SS2160GHD	15	60	21	133	15	\$1,540
		SS2154GHD	15	54	21	120	13	\$1,480

SWISH

ABOVE SURFACE STORAGE
Leg Supported

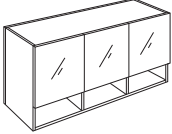
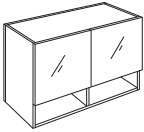
	Description	① Model	D	W	H	CTN WT	CU FT	List Price	
	Glass Storage Overhead Cabinet with Cubby Below	Right	15	48	21	110	12	\$1,291	
	· white back painted glass	Left	15	48	21	110	12	\$1,291	
	· aluminum frame doors								
	· support options must be purchased separately; see pages 158 and 160 for options	Right	SS2142GHDR	15	42	21	100	10	\$1,231
	· locking doors not available	Left	SS2142GHDL	15	42	21	100	10	\$1,231
	· right door configuration - 1 door hinges left and 2 doors hinge right · left door configuration - 1 door hinges right and 2 doors hinge left								
	Glass Storage Overhead Cabinet with Cubby Below	SS2136GHD	15	36	21	86	9	\$1,035	
	· white back painted glass	SS2130GHD	15	30	21	76	9	\$976	
	· aluminum frame doors · support options must be purchased separately, see pages 158 and 160 for options · locking doors not available								

SWISH

To Order, Specify:

- ① Model number
- ② Laminate color

② Laminate Color Options:







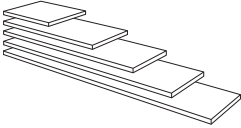

ALB	Alabaster	GRH	Graphite
AUT	Autumn	HGL	High Line
BLO	Blonde Echo	SHD	Shadow
BBN	Bourbon	SHE	Shea
BZW	Brazilwood	SLG	Slate Grey
BBL	Bridal Blanco	STU	Studio Teak
BRG	Brighton	TAU	Taupe
DWH	Designer White	VIN	Vintage
DOV	Dove Grey	WLH	Walnut Heights

Order Check List
page 149

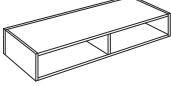
Product Specifications
page 40

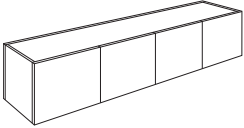

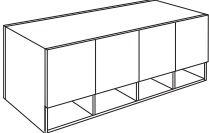



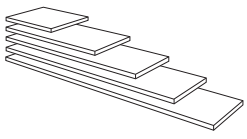

ABOVE SURFACE STORAGE SUPPORTS

Used with Executive Height Worksurfaces

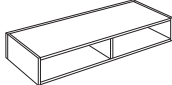
Description	Model	H	CTN WT	CU FT	List Price
 <p>Support for Transaction Top</p>	 <p>SSK-OHS-A · kit contains two supports · 40" overall height when used with executive height worksurface · support is required for each end of transaction top</p>	9 5/8	4	1	\$258
	 <p>SSK-OHS-B · kit contains two supports · 46" overall height when used with executive height worksurface · support is required for each end of transaction top</p>	15 5/8	5	1	\$285
 <p>Support for Cubby</p>	 <p>SSK-OHS-A · kit contains two supports · 45" overall height when used with executive height worksurfaces · support is required for each end of cubby</p>	9 5/8	4	1	\$258
	 <p>SSK-OHS-C · kit contains two supports · 54" overall height when used with executive height worksurfaces · support is required for each end of cubby</p>	18 5/8	5	1	\$300
 <p>Support for 15" High Overhead</p>	 <p>SSK-OHS-A · kit contains two supports · 54" overall height when used with executive height worksurfaces · support is required for each end of cubby</p>	9 5/8	4	1	\$258
	 <p>SSK-OHS-B · kit contains two supports · 60" overall height when used with executive height worksurfaces · support is required for each end of cubby</p>	15 5/8	5	1	\$285
 <p>Support for 21" High Overhead</p>	 <p>SSK-OHS-A · kit contains two supports · 60" overall height when used with executive height worksurfaces · support is required for each end of cubby</p>	9 5/8	4	1	\$258

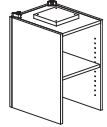
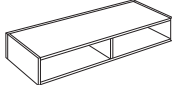
SWISH

ABOVE SURFACE STORAGE SUPPORTS
Used with Bench Height Units

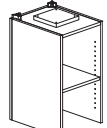
Description	Model	D	W	H	CTN WT	CU FT	List Price
Support for Transaction Top 	 SSK-OHS-D · kit contains two supports · 40" overall height when used with bench height storage units · support is required for each end of transaction top			19 1/8	6	2	\$302
	 SSK-OHS-E · kit contains two supports · 46" overall height when used with bench height storage units · support is required for each end of transaction top			25 1/8	6	2	\$328
Support for Cubby 	 SS15190T · side access shelves · sits on bench height unit · 40" overall height when used with bench height storage units · support is required for each end of transaction top	15	18	19 1/8	31	5	\$325
	 SS15250T · side access shelves · sits on bench height unit · 46" overall height when used with bench height storage units · support is required for each end of transaction top	15	18	25 1/8	37	6	\$342
Support for Cubby 	 SSK-OHS-D · kit contains two supports · 45" overall height when used with bench height storage units · support is required for each end of cubby			19 1/8	6	2	\$302
	 SSK-OHS-F · kit contains two supports · 54" overall height when used with bench height storage units · support is required for each end of cubby			28 1/8	8	2	\$343
	 SS15190T · side access shelves · sits on bench height unit · 45" overall height when used with bench height storage units · support is required for each end of cubby	15	18	19 1/8	31	5	\$325
	 SS15280T · side access shelves · sits on bench height unit · 54" overall height when used with bench height storage units · support is required for each end of cubby	15	18	28 1/8	40	6	\$354

To Order, Specify:

- 1 Model number
- 2 Laminate color

2 Laminate Color Options:







ALB Alabaster	GRH Graphite
AUT Autumn	HGL High Line
BLO Blonde Echo	SHD Shadow
BBN Bourbon	SHE Shea
BZW Brazilwood	SLG Slate Grey
BBL Bridal Blanco	STU Studio Teak
BRG Brighton	TAU Taupe
DWH Designer White	VIN Vintage
DOV Dove Grey	WLH Walnut Heights

Order Check List
page 149

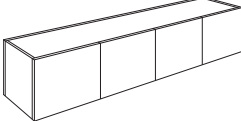
Product Specifications
page 40

ABOVE SURFACE STORAGE SUPPORTS

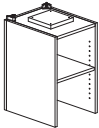
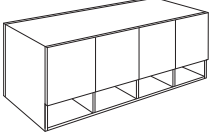
Used with Bench Height Units

Description	Model	D	W	H	CTN WT	CU FT	List Price
Support for 15" High Overhead 	 SSK-OHS-D · kit contains two supports · 54" overall height when used with bench height storage units · support is required for each end of overhead			19 1/8	6	2	\$302
	 SSK-OHS-E · kit contains two supports · 60" overall height when used with bench height storage units · support is required for each end of overhead			25 1/8	6	2	\$328
	 SS15190T · side access shelves · sits on bench height unit · 54" overall height when used with bench height storage units · support is required for each end of overhead	15	18	19 1/8	31	5	\$325
	 SS15250T · side access shelves · sits on bench height unit · 60" overall height when used with bench height storage units · support is required for each end of overhead	15	18	25 1/8	37	6	\$342
Support for 21" High Overhead 	 SSK-OHS-D · kit contains two supports · 60" overall height when used with bench height storage units · support is required for each end of overhead			19 1/8	6	2	\$302
	 SS15190T · side access shelves · sits on bench height unit · 60" overall height when used with bench height storage units · support is required for each end of overhead	15	18	19 1/8	31	5	\$325

SWISH

ABOVE SURFACE STORAGE
Wall Mount

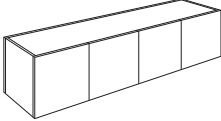
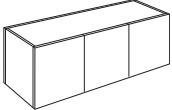
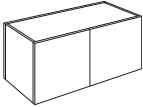
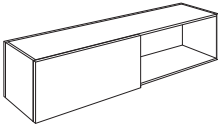
	Description	① Model	D	W	H	CTN WT	CU FT	List Price
	Wall Mount Overhead Cabinet · supported by wall cleat - hardware provided by installer · non-locking doors standard; locking doors available, specify and add \$210 list	SS1572WHD	15	72	15	114	13	\$1,007
		SS1566WHD	15	66	15	107	12	\$963
		SS1560WHD	15	60	15	99	11	\$928
		SS1554WHD	15	54	15	92	10	\$892
	Wall Mount Overhead Cabinet · supported by wall cleat - hardware provided by installer · non-locking doors standard; locking doors available, specify and add \$210 list · right door configuration - 1 door hinges left and 2 doors hinge right · left door configuration - 1 door hinges right and 2 doors hinge left	Right SS1548WHDR	15	48	15	85	9	\$842
		Left SS1548WHDL	15	48	15	85	9	\$842
		Right SS1542WHDR	15	42	15	77	8	\$796
		Left SS1542WHDL	15	42	15	77	8	\$796
	Wall Mount Overhead Cabinet · supported by wall cleat - hardware provided by installer · non-locking doors standard; locking doors available, specify and add \$105 list	SS1536WHD	15	36	15	66	7	\$723
		SS1530WHD	15	30	15	59	6	\$685
	Wall Mount Overhead Cabinet Sliding Door · supported by wall cleat - hardware provided by installer · locking door not available	SS1572WSD	15	72	15	103	13	\$1,165
		SS1566WSD	15	66	15	96	12	\$1,081
		SS1560WSD	15	60	15	90	11	\$1,039
		SS1554WSD	15	54	15	83	10	\$999
		SS1548WSD	15	48	15	77	9	\$957
		SS1542WSD	15	42	15	71	8	\$915
		SS1536WSD	15	36	15	64	7	\$871
		SS1530WSD	15	30	15	58	6	\$838

SWISH

To Order, Specify:

- ① Model number
- ② Laminate color

② Laminate Color Options:

ALB Alabaster	GRH Graphite
AUT Autumn	HGL High Line
BLO Blonde Echo	SHD Shadow
BBN Bourbon	SHE Shea
BZW Brazilwood	SLG Slate Grey
BBL Bridal Blanco	STU Studio Teak
BRG Brighton	TAU Taupe
DWH Designer White	VIN Vintage
DOV Dove Grey	WLH Walnut Heights

Order Check List
page 149

Product Specifications
page 40

ABOVE SURFACE STORAGE

Wall Mount

	Description	① Model	D	W	H	CTN WT	CU FT	List Price
	Wall Mount Overhead Cabinet Sliding Markerboard Door · markerboard doors feature an HPL laminate and a silver PVC edge banding · supported by wall cleat - hardware provided by installer · locking door not available	SS1572WDESD	15	72	15	103	13	\$1,326
		SS1566WDESD	15	66	15	96	12	\$1,243
		SS1560WDESD	15	60	15	90	11	\$1,202
		SS1554WDESD	15	54	15	83	10	\$1,162
		SS1548WDESD	15	48	15	77	9	\$1,120
		SS1542WDESD	15	42	15	71	8	\$1,076
		SS1536WDESD	15	36	15	64	7	\$1,032
		SS1530WDESD	15	30	15	58	6	\$999
	Wall Mount Open Overhead Cabinet · supported by wall cleat - hardware provided by installer · no center divider in 36" and 30" wide units	SS1572W00	15	72	15	91	13	\$780
		SS1566W00	15	66	15	85	12	\$742
		SS1560W00	15	60	15	80	11	\$714
		SS1554W00	15	54	15	74	10	\$685
		SS1548W00	15	48	15	69	9	\$657
		SS1542W00	15	42	15	63	8	\$625
		SS1536W00	15	36	15	54	7	\$582
		SS1530W00	15	30	15	48	6	\$553
	Glass Wall Mount Overhead Cabinet · white back painted glass · aluminum frame doors · supported by wall cleat - hardware provided by installer · locking doors not available	SS1572WGHD	15	72	15	114	13	\$1,616
		SS1566WGHD	15	66	15	107	12	\$1,561
		SS1560WGHD	15	60	15	99	11	\$1,497
		SS1554WGHD	15	54	15	92	10	\$1,449

SWISH

ABOVE SURFACE STORAGE
Wall Mount

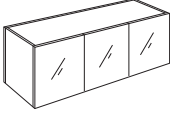
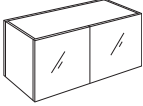
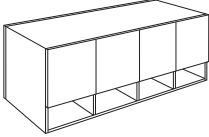
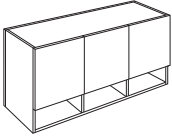
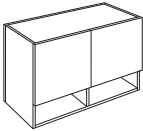
	Description	Model	D	W	H	CTN WT	CU FT	List Price
	Glass Wall Mount Overhead Cabinet	Right	15	48	15	85	9	\$1,267
	· white back painted glass	Left	15	48	15	85	9	\$1,267
	· aluminum frame doors							
	· supported by wall cleat - hardware provided by installer	Right	15	42	15	77	8	\$1,209
	· locking doors not available	Left	15	42	15	77	8	\$1,209
	· right door configuration - 1 door hinges left and 2 doors hinge right							
	· left door configuration - 1 door hinges right and 2 doors hinge left							
	Glass Wall Mount Overhead Cabinet		15	36	15	66	7	\$1,018
	· white back painted glass							
	· aluminum frame doors							
	· supported by wall cleat - hardware provided by installer		15	30	15	59	6	\$961
	· locking doors not available							
	Wall Mount Overhead Cabinet with Cubby Below		15	72	21	152	17	\$1,130
	· supported by wall cleat - hardware provided by installer							
	· non-locking doors standard; locking doors available, specify and add \$210 list		15	66	21	143	16	\$1,077
			15	60	21	133	15	\$1,034
			15	54	21	120	13	\$982
	Wall Mount Overhead Cabinet with Cubby Below	Right	15	48	21	110	12	\$914
		Left	15	48	21	110	12	\$914
	· supported by wall cleat - hardware provided by installer							
	· non-locking doors standard; locking doors available, specify and add \$210 list	Right	15	42	21	100	10	\$870
	· right door configuration - 1 door hinges left and 2 doors hinge right	Left	15	42	21	100	10	\$870
	· left door configuration - 1 door hinges right and 2 doors hinge left							
	Wall Mount Overhead Cabinet with Cubby Below		15	36	21	86	9	\$787
	· supported by wall cleat - hardware provided by installer							
	· non-locking doors standard; locking doors available, specify and add \$105 list		15	30	21	76	9	\$743

To Order, Specify:

- 1 Model number
- 2 Laminate color

2 Laminate Color Options:

ALB	Alabaster	GRH	Graphite
AUT	Autumn	HGL	High Line
BLO	Blonde Echo	SHD	Shadow
BBN	Bourbon	SHE	Shea
BZW	Brazilwood	SLG	Slate Grey
BBL	Bridal Blanco	STU	Studio Teak
BRG	Brighton	TAU	Taupe
DWH	Designer White	VIN	Vintage
DOV	Dove Grey	WLH	Walnut Heights

Order Check List
page 149

Product Specifications
page 40

ABOVE SURFACE STORAGE

Wall Mount

	Description	① Model	D	W	H	CTN WT	CU FT	List Price
	Wall Mount Overhead Cabinet Sliding Door with Cubby Below · supported by wall cleat - hardware provided by installer · locking door not available	SS2172WSD	15	72	21	141	17	\$1,283
		SS2166WSD	15	66	21	132	16	\$1,190
		SS2160WSD	15	60	21	123	15	\$1,142
		SS2154WSD	15	54	21	111	13	\$1,085
	Wall Mount Overhead Cabinet Sliding Door with Cubby Below · supported by wall cleat - hardware provided by installer · locking door not available	SS2148WSD	15	48	21	102	12	\$1,035
		SS2142WSD	15	42	21	93	10	\$985
		SS2136WSD	15	36	21	84	9	\$934
		SS2130WSD	15	30	21	75	8	\$894
	Wall Mount Overhead Cabinet Sliding Markerboard Door with Cubby Below · markerboard doors features an HPL laminate and a silver PVC edge banding · supported by wall cleat - hardware provided by installer · locking door not available	SS2172WDESD	15	72	21	141	17	\$1,444
		SS2166WDESD	15	66	21	132	16	\$1,352
		SS2160WDESD	15	60	21	123	15	\$1,305
		SS2154WDESD	15	54	21	111	13	\$1,246
		SS2148WDESD	15	48	21	102	12	\$1,197
		SS2142WDESD	15	42	21	93	10	\$1,146
		SS2136WDESD	15	36	21	84	9	\$1,096
		SS2130WDESD	15	30	21	75	8	\$1,056
	Wall Mount Open Overhead Cabinet with Cubby Below · supported by wall cleat - hardware provided by installer	SS2172W00	15	72	21	129	17	\$921
		SS2166W00	15	66	21	121	16	\$877
		SS2160W00	15	60	21	113	15	\$840
		SS2154W00	15	54	21	102	13	\$793
	Wall Mount Open Overhead Cabinet with Cubby Below · supported by wall cleat - hardware provided by installer · no center divider in 36" and 30" wide units	SS2148W00	15	48	21	94	12	\$756
		SS2142W00	15	42	21	86	10	\$719
		SS2136W00	15	36	21	74	9	\$666
		SS2130W00	15	30	21	66	8	\$629

ABOVE SURFACE STORAGE
Wall Mount

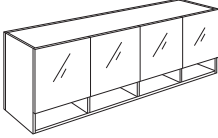
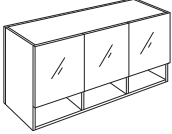
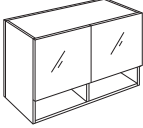
Description	① Model	D	W	H	CTN WT	CU FT	List Price	
 <p>Glass Wall Mount Overhead Cabinet with Cubby Below · white back painted glass · aluminum frame doors · supported by wall cleat - hardware provided by installer · locking doors not available</p>	SS2172WGHD	15	72	21	152	17	\$1,749	
	SS2166WGHD	15	66	21	143	16	\$1,685	
	SS2160WGHD	15	60	21	133	15	\$1,613	
	SS2154WGHD	15	54	21	120	13	\$1,549	
 <p>Glass Wall Mount Overhead Cabinet with Cubby Below · white back painted glass · aluminum frame doors · supported by wall cleat - hardware provided by installer · locking doors not available · right door configuration - 1 door hinges left and 2 doors hinge right · left door configuration - 1 door hinges right and 2 doors hinge left</p>	Right SS2148WGHDR	15	48	21	110	12	\$1,358	
	Left SS2148WGHDL	15	48	21	110	12	\$1,358	
	Right SS2142WGHDR	15	42	21	100	10	\$1,293	
	Left SS2142WGHDL	15	42	21	100	10	\$1,293	
	 <p>Glass Wall Mount Overhead Cabinet with Cubby Below · white back painted glass · aluminum frame doors · supported by wall cleat - hardware provided by installer · locking doors not available</p>	SS2136WGHD	15	36	21	86	9	\$1,096
		SS2130WGHD	15	30	21	76	9	\$1,032

SWISH

To Order, Specify:

- ① Model number
- ② Laminate color

② Laminate Color Options:

ALB Alabaster	GRH Graphite
AUT Autumn	HGL High Line
BLO Blonde Echo	SHD Shadow
BBN Bourbon	SHE Shea
BZW Brazilwood	SLG Slate Grey
BBL Bridal Blanco	STU Studio Teak
BRG Brighton	TAU Taupe
DWH Designer White	VIN Vintage
DOV Dove Grey	WLH Walnut Heights

Order Check List
page 149

Product Specifications
page 40

Accessories Order Check List:

Specify:

- 1. Model number
- 2. Fabric selection - vendor, pattern and color
- 3. Product options

Example:

SS1560ASF-TK2 (model #)	Culp (fabric vendor)	Montgomery (pattern name)	Sterling (pattern color)
-----------------------------------	-------------------------	------------------------------	-----------------------------

1. Model number

2. Fabric selection - Please supply the following:

Fabric vendor
 Pattern name
 Pattern color

NOTE: Vinyl cannot be used on tackboards

All COM orders must include the following:

- Vendor's name, pattern name and color
- Sample of the fabric attached to order
- Model numbers of items for fabric application
- Special application instructions
- Customer and purchase order number

Ship prepaid COM material to:
 JSI
 Attn: COM Dept
 932 Mill St.
 Jasper, Indiana 47546

Application of fabric:
 Railroaded

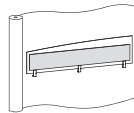

All COM orders will ship at standard lead time from receipt of COM.

3. Product Options:

Frosted is the standard for all acrylic modesty panels and privacy screens. Optional acrylic patterns are available, specify pattern name. Upcharge applies, refer to product pages. All privacy screens with a tackboard are only available with the frosted acrylic.

Optional patterns:

Drift Green	Paper Cut
Ivory Taipei	Silver Spun
Oyster Linen	

NOTE:

Accessory rails can be mounted to most worksurfaces. Contact Customer Service for availability if mounting to a modular bench height top. Rail must be installed at least 4" inset from the left and right sides of the worksurface.

When ordering a privacy screen be sure to take into account any above storage units so there is no interference.

Markerboards are available for the back and side of Tall Storage units, the side of Side Access Storage units and the back of Above Surface Storage units. Markerboards are not available on the Tall Storage doors. See pages 152, 155, 162 and 164 for Above Surface Storage units with sliding markerboard doors.

Tackboards are available for the back and side of Tall Storage units, the side of Side Access Storage units and the side of Above Surface Storage units. Tackboards are not available on the doors of these units.

DESKS AND CREDENZAS

Modesty will be centered in the opening

Left Side	Right Side	Top Width											
		30	36	42	48	54	60	66	72	78	84	90	96
Leg	Leg	—	25	31	37	43	49	55	61	67	—	—	—
Leg	9" Ped	—	—	25	31	37	43	49	55	61	67	—	—
Leg	18" Ped	—	—	—	22	28	34	40	46	52	58	64	—
Leg	24" Bench	—	—	—	—	22	28	34	40	46	52	58	64
Leg	30" Ped	—	—	—	—	—	22	28	34	40	46	52	58
Leg	36" Ped	—	—	—	—	—	—	22	28	34	40	46	52
9" Ped	Leg	—	—	25	31	37	43	49	55	61	67	—	—
9" Ped	9" Ped	—	—	—	25	31	37	43	49	55	61	67	—
9" Ped	18" Ped	—	—	—	—	22	28	34	40	46	52	58	64
9" Ped	24" Bench	—	—	—	—	—	22	28	34	40	46	52	58
9" Ped	30" Ped	—	—	—	—	—	—	22	28	34	40	46	52
9" Ped	36" Ped	—	—	—	—	—	—	—	22	28	34	40	46
18" Ped	Leg	—	—	—	22	28	34	40	46	52	58	64	—
18" Ped	9" Ped	—	—	—	—	22	28	34	40	46	52	58	64
18" Ped	18" Ped	—	—	—	—	—	—	25	31	37	43	49	55
18" Ped	24" Bench	—	—	—	—	—	—	—	25	31	37	43	49
18" Ped	30" Ped	—	—	—	—	—	—	—	—	25	31	37	43
18" Ped	36" Ped	—	—	—	—	—	—	—	—	—	25	31	37
30" Ped	Leg	—	—	—	—	—	22	28	34	40	46	52	58
30" Ped	9" Ped	—	—	—	—	—	—	22	28	34	40	46	52
30" Ped	18" Ped	—	—	—	—	—	—	—	—	25	31	37	43
30" Ped	24" Bench	—	—	—	—	—	—	—	—	—	25	31	37
30" Ped	30" Ped	—	—	—	—	—	—	—	—	—	—	25	31
30" Ped	36" Ped	—	—	—	—	—	—	—	—	—	—	—	25
36" Ped	Leg	—	—	—	—	—	—	22	28	34	40	46	52
36" Ped	9" Ped	—	—	—	—	—	—	—	22	28	34	40	46
36" Ped	18" Ped	—	—	—	—	—	—	—	—	—	25	31	37
36" Ped	24" Bench	—	—	—	—	—	—	—	—	—	—	25	31
36" Ped	30" Ped	—	—	—	—	—	—	—	—	—	—	—	25
36" Ped	36" Ped	—	—	—	—	—	—	—	—	—	—	—	—

SWISH

BRIDGES

Bridge	Top Width					
	30	36	42	48	54	60
Bridge Modesty	25	31	37	43	49	55

RETURNS

Return Ped	Top Width					
	30	36	42	48	54	60
Leg	22	28	34	40	46	52
9" Ped	—	22	28	34	40	46
18" Ped	—	—	—	25	31	37
30" Ped	—	—	—	—	—	25
36" Ped	—	—	—	—	—	—





ACCESSORIES

Accessory Rail

Description	① Model	D	W	H	CTN WT	CU FT	List Price
	SS0964AR · silver metal finish · requires 3/8" hole drilled into worksurface or top · mounting hardware included · field installed	1	65	9 1/4	6	1	\$366
	SS0958AR · silver metal finish · requires 3/8" hole drilled into worksurface or top · mounting hardware included · field installed	1	59	9 1/4	6	1	\$353
	SS0952AR · silver metal finish · requires 3/8" hole drilled into worksurface or top · mounting hardware included · field installed	1	53	9 1/4	5	1	\$343
	SS0946AR · silver metal finish · requires 3/8" hole drilled into worksurface or top · mounting hardware included · field installed	1	47	9 1/4	5	1	\$330
	SS0940AR · silver metal finish · requires 3/8" hole drilled into worksurface or top · mounting hardware included · field installed	1	39	9 1/4	5	1	\$318
	SS0934AR · silver metal finish · requires 3/8" hole drilled into worksurface or top · mounting hardware included · field installed	1	35	9 1/4	4	1	\$306
	SS0928AR · silver metal finish · requires 3/8" hole drilled into worksurface or top · mounting hardware included · field installed	1	29	9 1/4	4	1	\$293
	SS0922AR · silver metal finish · requires 3/8" hole drilled into worksurface or top · mounting hardware included · field installed	1	23	9 1/4	4	1	\$282
	SS0916AR · silver metal finish · requires 3/8" hole drilled into worksurface or top · mounting hardware included · field installed	1	17	9 1/4	3	1	\$270

SWISH

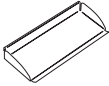
ACCESSORIES

DESCRIPTION	① MODEL	D	W	H	CTN WT	CU FT	LIST PRICE
UPRIGHT TRAY 	AC203CUP · pen and gadget cup · Stardust Silver finish	1 9/16	3 1/8	3 9/16	1	1	\$71
Small Tray 	AC403TRAY · tray for paper clips and other small items · Stardust Silver finish	3 5/16	2 11/16	7/8	1	1	\$53
Pencil Tray 	AC408TRAY · tray for pencils and other small items · Stardust Silver finish	3 5/16	7 11/16	7/8	1	1	\$65
Paper Tray 	AC912PAP · tray for 8 1/2" x 11" letter size paper · Stardust Silver finish	9 15/16	13 3/16	7/8	2	1	\$101

SWISH

To Order, Specify:

① Model number

Order Check List

page 166

Product Specifications

page 40

ACCESSORIES
Modesty Panel

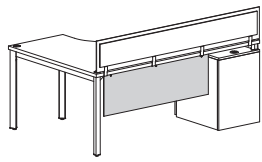

Description	① Model	D	W	H	CTN WT	CU FT	Frosted List Price	Premium List Price
15" High Modesty Panel · rectangle · frosted acrylic · optional premium patterns available, see page 166 · mounting hardware included · field installed	SS1567AMR	1/4	67	15	12	3	\$702	\$1,970
	SS1564AMR	1/4	64	15	12	3	\$678	\$1,890
	SS1561AMR	1/4	61	15	11	3	\$654	\$1,812
	SS1558AMR	1/4	58	15	11	3	\$627	\$1,730
	SS1555AMR	1/4	55	15	10	3	\$604	\$1,651
	SS1552AMR	1/4	52	15	10	3	\$579	\$1,571
	SS1549AMR	1/4	49	15	9	3	\$541	\$1,478
	SS1546AMR	1/4	46	15	9	2	\$513	\$1,394
	SS1543AMR	1/4	43	15	8	2	\$490	\$1,317
	SS1540AMR	1/4	40	15	8	2	\$462	\$1,235
	SS1537AMR	1/4	37	15	7	2	\$437	\$1,153
	SS1534AMR	1/4	34	15	7	2	\$413	\$1,073
	SS1531AMR	1/4	31	15	6	2	\$388	\$994
	SS1528AMR	1/4	28	15	5	2	\$364	\$914
	SS1525AMR	1/4	25	15	5	2	\$339	\$834
SS1522AMR	1/4	22	15	4	1	\$313	\$754	

SWISH

ACCESSORIES
Modesty Panel

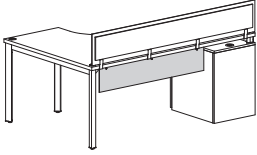
Description	① Model	D	W	H	CTN WT	CU FT	Frosted List Price	Premium List Price
 <p>9" High Modesty Panel · rectangle · frosted acrylic · optional premium patterns available, see page 166 · mounting hardware included · field installed</p>	SS0967AMR	1/4	67	9	8	2	\$525	\$1,319
	SS0964AMR	1/4	64	9	7	2	\$508	\$1,266
	SS0961AMR	1/4	61	9	7	2	\$490	\$1,215
	SS0958AMR	1/4	58	9	7	2	\$472	\$1,162
	SS0955AMR	1/4	55	9	6	2	\$454	\$1,108
	SS0952AMR	1/4	52	9	6	2	\$437	\$1,058
	SS0949AMR	1/4	49	9	6	2	\$407	\$993
	SS0946AMR	1/4	46	9	5	2	\$386	\$936
	SS0943AMR	1/4	43	9	5	2	\$368	\$886
	SS0940AMR	1/4	40	9	5	2	\$350	\$833
	SS0937AMR	1/4	37	9	4	1	\$331	\$777
	SS0934AMR	1/4	34	9	4	1	\$314	\$728
	SS0931AMR	1/4	31	9	4	1	\$301	\$676
	SS0928AMR	1/4	28	9	3	1	\$280	\$624
	SS0925AMR	1/4	25	9	3	1	\$261	\$567
SS0922AMR	1/4	22	9	3	1	\$245	\$520	

SWISH

To Order, Specify:

- ① Model number
- ② Product Options (see page 166)

Order Check List
page 166

Product Specifications
page 40

ACCESSORIES
Rectangle Privacy Screen

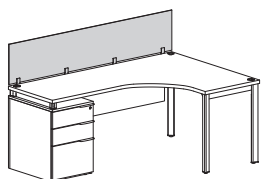

Description	① Model	D	W	H	CTN WT	CU FT	Frosted List Price	Premium List Price
15" High Rectangle Privacy Screen · frosted acrylic · optional premium patterns available, see page 166 · bracket attaches to underside of worksurface · mounting hardware included · field installed	SS1584ASR	1/4	83 3/4	15	15	4	\$826	\$2,368
	SS1578ASR	1/4	77 3/4	15	14	4	\$776	\$2,210
	SS1572ASR	1/4	71 3/4	15	13	3	\$712	\$2,035
	SS1566ASR	1/4	65 3/4	15	12	3	\$661	\$1,873
	SS1560ASR	1/4	59 3/4	15	11	3	\$608	\$1,712
	SS1554ASR	1/4	53 3/4	15	10	3	\$560	\$1,552
	SS1548ASR	1/4	47 3/4	15	9	2	\$510	\$1,392
	SS1542ASR	1/4	41 3/4	15	8	2	\$460	\$1,233
	SS1536ASR	1/4	35 3/4	15	7	2	\$402	\$1,063
	SS1530ASR	1/4	29 3/4	15	6	2	\$352	\$905
	SS1524ASR	1/4	23 3/4	15	5	2	\$303	\$743
	SS1518ASR	1/4	17 3/4	15	4	1	\$252	\$584

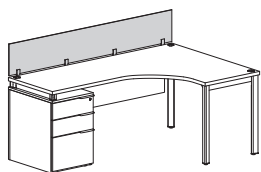

12" High Rectangle Privacy Screen · frosted acrylic · optional premium patterns available, see page 166 · bracket attaches to underside of worksurface · mounting hardware included · field installed	SS1284ASR	1/4	83 3/4	12	12	3	\$682	\$1,839
	SS1278ASR	1/4	77 3/4	12	12	3	\$643	\$1,718
	SS1272ASR	1/4	71 3/4	12	11	3	\$587	\$1,580
	SS1266ASR	1/4	65 3/4	12	10	3	\$546	\$1,457
	SS1260ASR	1/4	59 3/4	12	9	3	\$503	\$1,331
	SS1254ASR	1/4	53 3/4	12	8	2	\$465	\$1,209
	SS1248ASR	1/4	47 3/4	12	7	2	\$425	\$1,087
	SS1242ASR	1/4	41 3/4	12	6	2	\$386	\$963
	SS1236ASR	1/4	35 3/4	12	6	2	\$335	\$833
	SS1230ASR	1/4	29 3/4	12	5	2	\$297	\$710
	SS1224ASR	1/4	23 3/4	12	4	1	\$257	\$587
	SS1218ASR	1/4	17 3/4	12	3	1	\$217	\$466

ACCESSORIES
Rectangle Privacy Screen

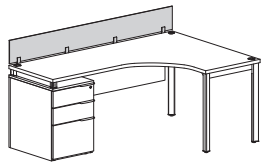

Description	① Model	D	W	H	CTN WT	CU FT	Frosted List Price	Premium List Price
9" High Rectangle Privacy Screen · frosted acrylic · optional premium patterns available, see page 166 · bracket attaches to underside of worksurface · mounting hardware included · field installed	SS0984ASR	1/4	83 3/4	9	10	3	\$611	\$1,575
	SS0978ASR	1/4	77 3/4	9	9	3	\$576	\$1,472
	SS0972ASR	1/4	71 3/4	9	8	2	\$527	\$1,353
	SS0966ASR	1/4	65 3/4	9	8	2	\$490	\$1,249
	SS0960ASR	1/4	59 3/4	9	7	2	\$453	\$1,141
	SS0954ASR	1/4	53 3/4	9	6	2	\$418	\$1,037
	SS0948ASR	1/4	47 3/4	9	6	2	\$383	\$934
	SS0942ASR	1/4	41 3/4	9	5	2	\$348	\$831
	SS0936ASR	1/4	35 3/4	9	4	2	\$304	\$717
	SS0930ASR	1/4	29 3/4	9	4	1	\$269	\$615
	SS0924ASR	1/4	23 3/4	9	3	1	\$235	\$510
	SS0918ASR	1/4	17 3/4	9	2	1	\$200	\$407

SWISH

To Order, Specify:

- ① Model number
- ② Product Options (see page 166)

Order Check List
page 166

Product Specifications
page 40

ACCESSORIES
Fin Privacy Screen

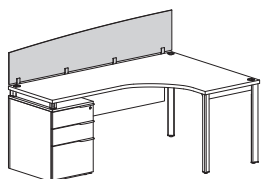

Description	① Model	D	W	H	CTN WT	CU FT	Frosted List Price	Premium List Price
15" High Fin Privacy Screen · arc spans from 12" to 15" · frosted acrylic · optional premium patterns available, see page 166 · bracket attaches to underside of worksurface · mounting hardware included · field installed	SS1584ASF	1/4	83 3/4	15	14	4	\$933	\$2,475
	SS1578ASF	1/4	77 3/4	15	13	4	\$884	\$2,317
	SS1572ASF	1/4	71 3/4	15	12	3	\$817	\$2,141
	SS1566ASF	1/4	65 3/4	15	11	3	\$768	\$1,980
	SS1560ASF	1/4	59 3/4	15	10	3	\$716	\$1,818
	SS1554ASF	1/4	53 3/4	15	9	3	\$666	\$1,658
	SS1548ASF	1/4	47 3/4	15	8	2	\$617	\$1,499
	SS1542ASF	1/4	41 3/4	15	7	2	\$540	\$1,313
	SS1536ASF	1/4	35 3/4	15	6	2	\$481	\$1,143
	SS1530ASF	1/4	29 3/4	15	5	2	\$432	\$984
	SS1524ASF	1/4	23 3/4	15	4	2	\$383	\$824
	SS1518ASF	1/4	17 3/4	15	3	1	\$333	\$664

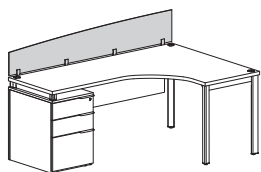

12" High Fin Privacy Screen · arc spans from 9" to 12" · frosted acrylic · optional premium patterns available, see page 166 · bracket attaches to underside of worksurface · mounting hardware included · field installed	SS1284ASF	1/4	83 3/4	12	11	3	\$789	\$1,946
	SS1278ASF	1/4	77 3/4	12	11	3	\$750	\$1,825
	SS1272ASF	1/4	71 3/4	12	10	3	\$695	\$1,687
	SS1266ASF	1/4	65 3/4	12	9	3	\$654	\$1,564
	SS1260ASF	1/4	59 3/4	12	8	3	\$611	\$1,438
	SS1254ASF	1/4	53 3/4	12	7	2	\$572	\$1,316
	SS1248ASF	1/4	47 3/4	12	6	2	\$532	\$1,194
	SS1242ASF	1/4	41 3/4	12	5	2	\$466	\$1,044
	SS1236ASF	1/4	35 3/4	12	5	2	\$416	\$913
	SS1230ASF	1/4	29 3/4	12	4	2	\$377	\$790
	SS1224ASF	1/4	23 3/4	12	3	1	\$338	\$667
	SS1218ASF	1/4	17 3/4	12	2	1	\$298	\$546

ACCESSORIES
Rectangle Privacy Screen
With Tackboard

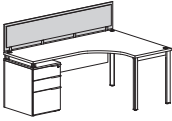
Description	① Model	Fabric Grade/List Price											
		COM	A	B	C	D	E	F	G	H	I	J	
15" High Rectangle Privacy Screen with Tackboard  <ul style="list-style-type: none"> · Frosted acrylic · Tackboard on both sides · Culp Montgomery Sterling panel fabric standard · Use grade A pricing · Other fabrics available, see pages 218-222 or contact Customer Service · Bracket attaches to underside of worksurface · Mounting hardware included · Field installed 	SS1584ASR-TK2	\$1,162	\$1,189	\$1,243	\$1,337	\$1,458	\$1,579	\$1,768	\$1,969	\$2,183	\$2,519	\$2,923	
	D 1 W 83 3/4 H 15												
	COM YDG 2 3/4												
	CTN WT 26												
	CU FT 4												
	SS1578ASR-TK2	\$1,089	\$1,115	\$1,163	\$1,249	\$1,359	\$1,468	\$1,640	\$1,823	\$2,019	\$2,324	\$2,691	
	D 1 W 77 3/4 H 15												
COM YDG 2 1/2													
CTN WT 24													
CU FT 4													
SS1572ASR-TK2	\$1,001	\$1,024	\$1,067	\$1,145	\$1,244	\$1,342	\$1,497	\$1,662	\$1,837	\$2,112	\$2,442		
D 1 W 71 3/4 H 15													
COM YDG 2 1/4													
CTN WT 22													
CU FT 3													
SS1566ASR-TK2	\$941	\$964	\$1,007	\$1,085	\$1,184	\$1,283	\$1,437	\$1,602	\$1,777	\$2,052	\$2,382		
D 1 W 65 3/4 H 15													
COM YDG 2 1/4													
CTN WT 20													
CU FT 3													
SS1560ASR-TK2	\$865	\$885	\$923	\$993	\$1,080	\$1,168	\$1,305	\$1,452	\$1,608	\$1,853	\$2,146		
D 1 W 59 3/4 H 15													
COM YDG 2													
CTN WT 19													
CU FT 3													
SS1554ASR-TK2	\$796	\$814	\$848	\$908	\$985	\$1,062	\$1,182	\$1,310	\$1,447	\$1,661	\$1,917		
D 1 W 53 3/4 H 15													
COM YDG 1 3/4													
CTN WT 17													
CU FT 3													

SWISH

To Order, Specify:

- ① Model number
- ② Fabric selection: vendor, pattern, color
- ③ Product Options (see page 166)

Order Check List
page 166

Product Specifications
page 40

ACCESSORIES

Rectangle Privacy Screen
With Tackboard

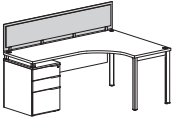
Description	① Model	Fabric Grade/List Price											
		COM	A	B	C	D	E	F	G	H	I	J	
15" High Rectangle Privacy Screen with Tackboard  <ul style="list-style-type: none"> · Frosted acrylic · Tackboard on both sides · Culp Montgomery Sterling panel fabric standard · Use grade A pricing · Other fabrics available, see pages 218-222 or contact Customer Service · Bracket attaches to underside of worksurface · Mounting hardware included · Field installed 	SS1548ASR-TK2	\$739	\$756	\$790	\$850	\$928	\$1,004	\$1,124	\$1,252	\$1,390	\$1,603	\$1,859	
	D 1 W 47 ¾ H 15												
	COM YDG 1 ¾												
	CTN WT 15												
	CU FT 2												
	SS1542ASR-TK2	\$669	\$685	\$713	\$765	\$831	\$897	\$1,000	\$1,109	\$1,227	\$1,411	\$1,630	
	D 1 W 41 ¾ H 15												
COM YDG 1 ½													
CTN WT 13													
CU FT 2													
SS1536ASR-TK2	\$588	\$601	\$625	\$668	\$724	\$779	\$864	\$956	\$1,054	\$1,206	\$1,390		
D 1 W 35 ¾ H 15													
COM YDG 1 ¼													
CTN WT 12													
CU FT 2													
SS1530ASR-TK2	\$530	\$542	\$566	\$609	\$665	\$720	\$805	\$897	\$995	\$1,147	\$1,331		
D 1 W 29 ¾ H 15													
COM YDG 1 ¼													
CTN WT 10													
CU FT 2													
SS1524ASR-TK2	\$456	\$467	\$486	\$520	\$564	\$608	\$677	\$750	\$828	\$951	\$1,097		
D 1 W 23 ¾ H 15													
COM YDG 1													
CTN WT 8													
CU FT 2													
SS1518ASR-TK2	\$390	\$398	\$412	\$438	\$471	\$504	\$556	\$611	\$669	\$761	\$871		
D 1 W 17 ¾ H 15													
COM YDG ¾													
CTN WT 6													
CU FT 1													

SWISH

ACCESSORIES
Rectangle Privacy Screen
With Tackboard

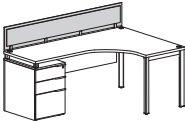
Description	① Model	Fabric Grade/List Price											
		COM	A	B	C	D	E	F	G	H	I	J	
12" High Rectangle Privacy Screen with Tackboard  <ul style="list-style-type: none"> · Frosted acrylic · Tackboard on both sides · Culp Montgomery Sterling panel fabric standard · Use grade A pricing · Other fabrics available, see pages 218-222 or contact Customer Service · Bracket attaches to underside of worksurface · Mounting hardware included · Field installed 	SS1284ASR-TK2	\$1,003	\$1,031	\$1,084	\$1,179	\$1,299	\$1,420	\$1,609	\$1,811	\$2,025	\$2,361	\$2,764	
	D 1 W 83 3/4 H 12												
	COM YDG 2 3/4												
	CTN WT 19												
	CU FT 3												
	SS1278ASR-TK2	\$943	\$969	\$1,017	\$1,103	\$1,213	\$1,322	\$1,494	\$1,677	\$1,873	\$2,178	\$2,545	
	D 1 W 77 3/4 H 12												
COM YDG 2 1/2													
CTN WT 19													
CU FT 3													
SS1272ASR-TK2	\$865	\$888	\$931	\$1,008	\$1,107	\$1,206	\$1,360	\$1,525	\$1,700	\$1,976	\$2,305		
D 1 W 71 3/4 H 12													
COM YDG 2 1/4													
CTN WT 17													
CU FT 3													
SS1266ASR-TK2	\$814	\$837	\$880	\$958	\$1,057	\$1,155	\$1,310	\$1,475	\$1,650	\$1,925	\$2,255		
D 1 W 65 3/4 H 12													
COM YDG 2 1/4													
CTN WT 16													
CU FT 3													
SS1260ASR-TK2	\$751	\$771	\$810	\$879	\$966	\$1,055	\$1,191	\$1,338	\$1,495	\$1,739	\$2,032		
D 1 W 59 3/4 H 12													
COM YDG 2													
CTN WT 14													
CU FT 3													
SS1254ASR-TK2	\$693	\$711	\$745	\$805	\$882	\$959	\$1,079	\$1,207	\$1,344	\$1,558	\$1,814		
D 1 W 53 3/4 H 12													
COM YDG 1 3/4													
CTN WT 13													
CU FT 2													

To Order, Specify:

- ① Model number
- ② Fabric selection: vendor, pattern, color
- ③ Product Options (see page 166)

Order Check List
page 166

Product Specifications
page 40

ACCESSORIES

Rectangle Privacy Screen
With Tackboard

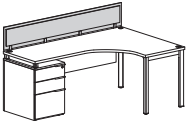
Description	① Model	Fabric Grade/List Price											
		COM	A	B	C	D	E	F	G	H	I	J	
12" High Rectangle Privacy Screen with Tackboard  <ul style="list-style-type: none"> · Frosted acrylic · Tackboard on both sides · Culp Montgomery Sterling panel fabric standard · Use grade A pricing · Other fabrics available, see pages 218-222 or contact Customer Service · Bracket attaches to underside of worksurface · Mounting hardware included · Field installed 	SS1248ASR-TK2	\$646	\$664	\$698	\$758	\$835	\$912	\$1,032	\$1,160	\$1,297	\$1,510	\$1,767	
	D 1 W 47 ¾ H 12												
	COM YDG 1 ¾												
	CTN WT 11												
	CU FT 2												
	<hr/>												
	SS1242ASR-TK2	\$592	\$607	\$636	\$687	\$753	\$819	\$922	\$1,032	\$1,149	\$1,333	\$1,552	
D 1 W 41 ¾ H 12													
COM YDG 1 ½													
CTN WT 10													
CU FT 2													
<hr/>													
SS1236ASR-TK2	\$517	\$530	\$554	\$597	\$653	\$707	\$792	\$885	\$982	\$1,134	\$1,318		
D 1 W 35 ¾ H 12													
COM YDG 1 ¼													
CTN WT 9													
CU FT 2													
<hr/>													
SS1230ASR-TK2	\$469	\$481	\$506	\$549	\$604	\$659	\$744	\$836	\$934	\$1,086	\$1,270		
D 1 W 29 ¾ H 12													
COM YDG 1 ¼													
CTN WT 8													
CU FT 2													
<hr/>													
SS1224ASR-TK2	\$407	\$417	\$436	\$471	\$515	\$559	\$627	\$701	\$779	\$901	\$1,047		
D 1 W 23 ¾ H 12													
COM YDG 1													
CTN WT 6													
CU FT 1													
<hr/>													
SS1218ASR-TK2	\$352	\$361	\$374	\$401	\$433	\$467	\$518	\$573	\$632	\$723	\$833		
D 1 W 17 ¾ H 12													
COM YDG ¾													
CTN WT 5													
CU FT 1													

SWISH

ACCESSORIES
Fin Privacy Screen
With Tackboard

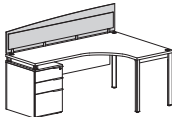
Description	① Model	Fabric Grade/List Price											
		COM	A	B	C	D	E	F	G	H	I	J	
15" High Fin Privacy Screen with Tackboard  <ul style="list-style-type: none"> · Arc spans 12" to 15" · Frosted acrylic · Tackboard on both sides · Culp Montgomery Sterling panel fabric standard · Use grade A pricing · Other fabrics available, see pages 218-222 or contact Customer Service · Bracket attaches to underside of worksurface · Mounting hardware included · Field installed 	SS1584ASF-TK2	\$1,254	\$1,281	\$1,335	\$1,430	\$1,550	\$1,671	\$1,860	\$2,062	\$2,276	\$2,612	\$3,015	
	D 1 W 83 3/4 H 15												
	COM YDG 2 3/4												
	CTN WT 21												
	CU FT 4												
	<hr/>												
	SS1578ASF-TK2	\$1,183	\$1,208	\$1,256	\$1,342	\$1,453	\$1,562	\$1,733	\$1,917	\$2,112	\$2,418	\$2,784	
D 1 W 77 3/4 H 15													
COM YDG 2 1/2													
CTN WT 20													
CU FT 4													
<hr/>													
SS1572ASF-TK2	\$1,096	\$1,119	\$1,162	\$1,239	\$1,338	\$1,437	\$1,591	\$1,756	\$1,931	\$2,207	\$2,536		
D 1 W 71 3/4 H 15													
COM YDG 2 1/4													
CTN WT 18													
CU FT 3													
<hr/>													
SS1566ASF-TK2	\$1,036	\$1,059	\$1,102	\$1,180	\$1,278	\$1,377	\$1,531	\$1,696	\$1,872	\$2,147	\$2,476		
D 1 W 67 3/4 H 15													
COM YDG 2 1/4													
CTN WT 17													
CU FT 3													
<hr/>													
SS1560ASF-TK2	\$962	\$982	\$1,021	\$1,090	\$1,178	\$1,266	\$1,402	\$1,549	\$1,706	\$1,950	\$2,243		
D 1 W 59 3/4 H 15													
COM YDG 2													
CTN WT 15													
CU FT 3													
<hr/>													
SS1554ASF-TK2	\$895	\$913	\$947	\$1,006	\$1,084	\$1,161	\$1,280	\$1,409	\$1,546	\$1,759	\$2,015		
D 1 W 53 3/4 H 15													
COM YDG 1 3/4													
CTN WT 14													
CU FT 3													

SWISH

To Order, Specify:

- ① Model number
- ② Fabric selection: vendor, pattern, color
- ③ Product Options (see page 166)

Order Check List
page 166

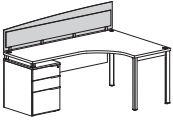

Product Specifications
page 40

ACCESSORIES
Fin Privacy Screen
With Tackboard

Description	① Model	Fabric Grade/List Price										
		COM	A	B	C	D	E	F	G	H	I	J
15" High Fin Privacy Screen with Tackboard  <ul style="list-style-type: none"> · Arc spans 12" to 15" · Frosted acrylic · Tackboard on both sides · Culp Montgomery Sterling panel fabric standard · Use grade A pricing · Other fabrics available, see pages 218-222 or contact Customer Service · Bracket attaches to underside of worksurface · Mounting hardware included · Field installed 	SS1548ASF-TK2	\$838	\$856	\$890	\$950	\$1,027	\$1,104	\$1,224	\$1,352	\$1,489	\$1,703	\$1,959
	D 1 W 47 3/4 H 15											
	COM YDG 1 3/4											
	CTN WT 12											
	CU FT 2											
	<hr/>											
	SS1542ASF-TK2	\$747	\$763	\$791	\$843	\$909	\$975	\$1,078	\$1,187	\$1,305	\$1,488	\$1,708
D 1 W 41 3/4 H 15												
COM YDG 1 1/2												
CTN WT 11												
CU FT 2												
<hr/>												
	SS1536ASF-TK2	\$663	\$676	\$700	\$743	\$798	\$853	\$938	\$1,031	\$1,128	\$1,280	\$1,464
D 1 W 35 3/4 H 15												
COM YDG 1 1/4												
CTN WT 9												
CU FT 2												
<hr/>												
	SS1530ASF-TK2	\$605	\$618	\$642	\$685	\$741	\$795	\$880	\$973	\$1,070	\$1,223	\$1,406
D 1 W 29 3/4 H 15												
COM YDG 1 1/4												
CTN WT 8												
CU FT 2												
<hr/>												
	SS1524ASF-TK2	\$533	\$543	\$562	\$597	\$641	\$685	\$753	\$827	\$905	\$1,027	\$1,173
D 1 W 23 3/4 H 15												
COM YDG 1												
CTN WT 6												
CU FT 2												
<hr/>												
	SS1518ASF-TK2	\$468	\$476	\$490	\$516	\$549	\$582	\$634	\$688	\$747	\$838	\$949
D 1 W 17 3/4 H 15												
COM YDG 3/4												
CTN WT 5												
CU FT 1												

SWISH

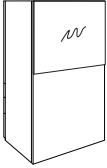
ACCESSORIES
Markerboard for
Back of Tall Storage

	Description	① Model	D	W	H	CTN WT	CU FT	List Price
	Markerboard for Back of 60" Tall Storage · used with 36" wide x 60" tall storage · used for drawer side on storage cabinet with side access · HPL laminate with a silver PVC edge · mounts to back side of unit · field installed · attaches with 3M dual lock · 4 markers and eraser included	SS2736DEB	3/8	36	27	14	3	\$363
	Markerboard for Back of 60" Tall Storage · used with 30" wide x 60" tall storage · used for drawer side on storage cabinet with side access · HPL laminate with a silver PVC edge · mounts to back side of unit · field installed · attaches with 3M dual lock · 4 markers and eraser included	SS2730DEB	3/8	30	27	11	3	\$333
	Markerboard for Back of 60" Tall Storage · used with 18" wide x 60" tall storage · used for drawer side on storage cabinet with side access · HPL laminate with a silver PVC edge · mounts to back side of unit · field installed · attaches with 3M dual lock · 4 markers and eraser included	SS2718DEB	3/8	18	27	7	2	\$271
	Markerboard for Back of 54" Tall Storage · used with 36" wide x 54" tall storage · used for drawer side on storage cabinet with side access · HPL laminate with a silver PVC edge · mounts to back side of unit · field installed · attaches with 3M dual lock · 4 markers and eraser included	SS2136DEB	3/8	36	21	11	3	\$322
	Markerboard for Back of 54" Tall Storage · used with 30" wide x 54" tall storage · used for drawer side on storage cabinet with side access · HPL laminate with a silver PVC edge · mounts to back side of unit · field installed · attaches with 3M dual lock · 4 markers and eraser included	SS2130DEB	3/8	30	21	9	2	\$301
	Markerboard for Back of 54" Tall Storage · used with 18" wide x 54" tall storage · used for drawer side on storage cabinet with side access · HPL laminate with a silver PVC edge · mounts to back side of unit · field installed · attaches with 3M dual lock · 4 markers and eraser included	SS2118DEB	3/8	18	21	6	2	\$249

SWISH

To Order, Specify:

- ① Model number
- ② Fabric selection: vendor, pattern, color
- ③ Product Options (see page 166)

Order Check List
page 166

Product Specifications
page 40

ACCESSORIES
 Markerboard for
 Back of Tall Storage

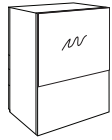

Description	① Model	D	W	H	CTN WT	CU FT	List Price
Markerboard for Back of 45" Tall Storage · used with 36" wide x 45" tall storage · used for drawer side on storage cabinet with side access · HPL laminate with a silver PVC edge · mounts to back side of unit · field installed · attaches with 3M dual lock · 4 markers and eraser included	SS1236DEB	3/8	36	12	6	2	\$266
Markerboard for Back of 45" Tall Storage · used with 30" wide x 45" tall storage · used for drawer side on storage cabinet with side access · HPL laminate with a silver PVC edge · mounts to back side of unit · field installed · attaches with 3M dual lock · 4 markers and eraser included	SS1230DEB	3/8	30	12	5	2	\$244
Markerboard for Back of 45" Tall Storage · used with 18" wide x 45" tall storage · used for drawer side on storage cabinet with side access · HPL laminate with a silver PVC edge · mounts to back side of unit · field installed · attaches with 3M dual lock · 4 markers and eraser included	SS1218DEB	3/8	18	12	3	1	\$212

SWISH

ACCESSORIES
Markerboard for
Side of Tall Storage

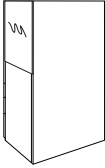
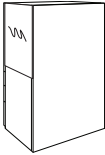
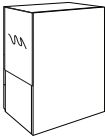
	Description	① Model	D	W	H	CTN WT	CU FT	List Price
	Markerboard for Side of 60" Tall Storage · used with 24" deep x 60" tall storage · HPL laminate with a silver PVC edge · mounts to side of unit · field installed · attaches with 3M dual lock · 4 markers and eraser included	SS2723DEB	3/8	23	27	9	2	\$298
	Markerboard for Side of 60" Tall Storage · used with 18" deep x 60" tall storage · HPL laminate with a silver PVC edge · mounts to side of unit · field installed · attaches with 3M dual lock · 4 markers and eraser included	SS2717DEB	3/8	17	27	7	2	\$267
	Markerboard for Side of 54" Tall Storage · used with 24" deep x 54" tall storage · HPL laminate with a silver PVC edge · mounts to side of unit · field installed · attaches with 3M dual lock · 4 markers and eraser included	SS2123DEB	3/8	23	21	7	2	\$270
	Markerboard for Side of 54" Tall Storage · used with 18" deep x 54" tall storage · HPL laminate with a silver PVC edge · mounts to side of unit · field installed · attaches with 3M dual lock · 4 markers and eraser included	SS2117DEB	3/8	17	21	5	2	\$245
	Markerboard for Side of 45" Tall Storage · used with 24" deep x 45" tall storage · HPL laminate with a silver PVC edge · mounts to side of unit · field installed · attaches with 3M dual lock · 4 markers and eraser included	SS1223DEB	3/8	23	12	4	1	\$234
	Markerboard for Side of 45" Tall Storage · used with 18" deep x 45" tall storage · HPL laminate with a silver PVC edge · mounts to side of unit · field installed · attaches with 3M dual lock · 4 markers and eraser included	SS1217DEB	3/8	17	12	3	1	\$209

SWISH

To Order, Specify:

① Model number

Order Check List
page 166

Product Specifications
page 40

ACCESSORIES
 Markerboard for
 Side of Tall Storage

	Description	① Model	D	W	H	CTN WT	CU FT	List Price
	Markerboard for Side of 28" Tall Side Access Storage · used with 15" deep x 28" tall side access cabinet · HPL laminate with a silver PVC edge · mounts to side of unit · field installed · attaches with 3M dual lock · 4 markers and eraser included	SS2118DEB	3/8	18	21	62		\$249
	Markerboard for Side of 25" Tall Side Access Storage · used with 15" deep x 25" tall side access cabinet · HPL laminate with a silver PVC edge · mounts to side of unit · field installed · attaches with 3M dual lock · 4 markers and eraser included	SS1818DEB	3/8	18	18	5	2	\$240
	Markerboard for Side of 19" Tall Side Access Storage · used with 15" deep x 19" tall side access cabinet · HPL laminate with a silver PVC edge · mounts to side of unit · field installed · attaches with 3M dual lock · 4 markers and eraser included	SS1218DEB	3/8	18	12	3	1	\$212

SWISH

ACCESSORIES
Markerboard for
Above Surface Storage

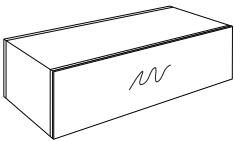
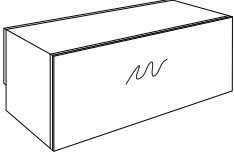
	Description	Model	D	W	H	CTN WT	CU FT	List Price
	Markerboard for Back of 15" High Overhead · used with 15" high overhead · HPL laminate with a silver PVC edge · mounts to back side of overhead · field installed · attaches with 3M dual lock · 4 markers and eraser included	SS1584DEB	3/8	84	15	17	4	\$436
		SS1578DEB	3/8	78	15	16	4	\$418
		SS1572DEB	3/8	72	15	15	3	\$401
		SS1566DEB	3/8	66	15	14	3	\$376
		SS1560DEB	3/8	60	15	13	3	\$357
		SS1554DEB	3/8	54	15	11	3	\$341
		SS1548DEB	3/8	48	15	10	2	\$322
		SS1542DEB	3/8	42	15	9	2	\$305
		SS1536DEB	3/8	36	15	8	2	\$285
		SS1530DEB	3/8	30	15	7	2	\$269
	Markerboard for Back of 21" High Overhead · used with 21" high overhead · HPL laminate with a silver PVC edge · mounts to back side of overhead · field installed · attaches with 3M dual lock · 4 markers and eraser included	SS2184DEB	3/8	84	21	24	5	\$517
		SS2178DEB	3/8	78	21	23	5	\$495
		SS2172DEB	3/8	72	21	21	4	\$471
		SS2166DEB	3/8	66	21	19	4	\$441
		SS2160DEB	3/8	60	21	17	4	\$417
		SS2154DEB	3/8	54	21	16	3	\$394
		SS2148DEB	3/8	48	21	14	3	\$370
		SS2142DEB	3/8	42	21	12	3	\$348
		SS2136DEB	3/8	36	21	11	3	\$322
		SS2130DEB	3/8	30	21	9	2	\$301

SWISH

To Order, Specify:
 1 Model number

Order Check List
 page 166

Product Specifications
 page 40

ACCESSORIES

Tackboard for Back of Tall Storage

Description	① Model	Fabric Grade/List Price										
		COM	A	B	C	D	E	F	G	H	I	J

- Tackboard for Back of 60" Tall Storage**
- Culp Montgomery Sterling panel fabric standard
 - Use grade A pricing
 - Other fabrics available, see pages 218-222 or contact Customer Service
 - Mounts to the back side of unit
 - Used for drawer side on storage cabinet with side access
 - Attaches with covered button screws

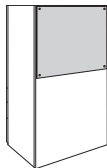

SS2736TK	\$174	\$186	\$210	\$254	\$309	\$364	\$449	\$541	\$639	\$791	\$975
-----------------	-------	-------	-------	-------	-------	-------	-------	-------	-------	-------	-------

· used with 36" wide x 60" tall storage

D $\frac{3}{8}$ W 36 H 27
 COM YDG 1 $\frac{1}{4}$
 CTN WT 7
 CU FT 3

SS2730TK	\$171	\$183	\$207	\$250	\$306	\$361	\$446	\$538	\$636	\$788	\$972
-----------------	-------	-------	-------	-------	-------	-------	-------	-------	-------	-------	-------

· used with 30" wide x 60" tall storage

D $\frac{3}{8}$ W 30 H 27
 COM YDG 1 $\frac{1}{4}$
 CTN WT 6
 CU FT 3

SS2718TK	\$138	\$146	\$160	\$186	\$219	\$252	\$304	\$359	\$417	\$509	\$619
-----------------	-------	-------	-------	-------	-------	-------	-------	-------	-------	-------	-------

· used with 18" wide x 60" tall storage

D $\frac{3}{8}$ W 18 H 27
 COM YDG $\frac{3}{4}$
 CTN WT 4
 CU FT 2

- Tackboard for Back of 54" Tall Storage**
- Culp Montgomery Sterling panel fabric standard
 - Use grade A pricing
 - Other fabrics available, see pages 218-222 or contact Customer Service
 - Mounts to the back side of unit
 - Used for drawer side on storage cabinet with side access
 - Attaches with covered button screws

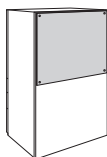

SS2136TK	\$175	\$187	\$212	\$255	\$310	\$365	\$450	\$542	\$640	\$792	\$976
-----------------	-------	-------	-------	-------	-------	-------	-------	-------	-------	-------	-------

· used with 36" wide x 54" tall storage

D $\frac{3}{8}$ W 36 H 21
 COM YDG 1 $\frac{1}{4}$
 CTN WT 5
 CU FT 3

SS2130TK	\$173	\$185	\$209	\$252	\$308	\$363	\$448	\$540	\$638	\$790	\$974
-----------------	-------	-------	-------	-------	-------	-------	-------	-------	-------	-------	-------

· used with 30" wide x 54" tall storage

D $\frac{3}{8}$ W 30 H 21
 COM YDG 1 $\frac{1}{4}$
 CTN WT 5
 CU FT 2

SS2118TK	\$135	\$143	\$157	\$183	\$216	\$249	\$301	\$355	\$414	\$506	\$616
-----------------	-------	-------	-------	-------	-------	-------	-------	-------	-------	-------	-------

· used with 18" wide x 54" tall storage

D $\frac{3}{8}$ W 18 H 21
 COM YDG $\frac{3}{4}$
 CTN WT 3
 CU FT 2

ACCESSORIES
Tackboard for
Back of Tall Storage

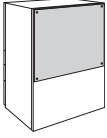
Description	① Model	Fabric Grade/List Price										
		COM	A	B	C	D	E	F	G	H	I	J
Tackboard for Back of 45" Tall Storage 	<ul style="list-style-type: none"> · Culp Montgomery Sterling panel fabric standard · Use grade A pricing · Other fabrics available, see pages 218-222 or contact Customer Service · Mounts to the back side of unit · Used for drawer side on storage cabinet with side access · Attaches with covered button screws 											
	SS1236TK · used with 36" wide x 45" tall storage D ¾ W 36 H 12 COM YDG 1¼ CTN WT 3 CU FT 2	\$163	\$176	\$200	\$243	\$299	\$353	\$438	\$531	\$628	\$781	\$964
	SS1230TK · used with 30" wide x 45" tall storage D ¾ W 30 H 12 COM YDG 1¼ CTN WT 3 CU FT 2	\$162	\$175	\$199	\$242	\$298	\$352	\$437	\$530	\$627	\$780	\$963
	SS1218TK · used with 18" wide x 45" tall storage D ¾ W 18 H 12 COM YDG ¾ CTN WT 2 CU FT 1	\$126	\$135	\$149	\$175	\$207	\$241	\$292	\$347	\$406	\$497	\$607

SWISH

To Order, Specify:

- ① Model number
- ② Fabric selection: vendor, pattern, color

Order Check List
page 166

Product Specifications
page 40

ACCESSORIES

Tackboard for Side of Tall Storage

Description	① Model	Fabric Grade/List Price									
		COM	A	B	C	D	E	F	G	H	I

- Tackboard for Side of 60" Tall Storage**
- Culp Montgomery Sterling panel fabric standard
 - Use grade A pricing
 - Other fabrics available, see pages 218-222 or contact Customer Service
 - Mounts to the side of unit
 - Attaches with covered button screws

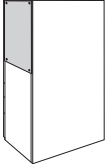

SS2723TK	\$155	\$165	\$184	\$219	\$263	\$307	\$375	\$449	\$527	\$649	\$795
· used with 24" deep x 60" tall storage											
D $\frac{3}{8}$ W 23 H 27											
COM YDG 1											
CTN WT 4											
CU FT 2											

SS2717TK	\$137	\$145	\$159	\$185	\$218	\$251	\$303	\$357	\$416	\$508	\$618
· used with 18" deep x 60" tall storage											
D $\frac{3}{8}$ W 17 H 27											
COM YDG $\frac{3}{4}$											
CTN WT 3											
CU FT 2											

- Tackboard for Side of 54" Tall Storage**
- Culp Montgomery Sterling panel fabric standard
 - Use grade A pricing
 - Other fabrics available, see pages 218-222 or contact Customer Service
 - Mounts to the side of unit
 - Attaches with covered button screws

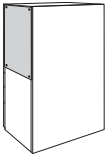

SS2123TK	\$152	\$162	\$181	\$216	\$260	\$304	\$372	\$446	\$523	\$646	\$792
· used with 24" deep x 54" tall storage											
D $\frac{3}{8}$ W 23 H 21											
COM YDG 1											
CTN WT 4											
CU FT 2											

SS2117TK	\$135	\$143	\$157	\$183	\$216	\$249	\$301	\$355	\$414	\$506	\$616
· used with 18" deep x 54" tall storage											
D $\frac{3}{8}$ W 17 H 21											
COM YDG $\frac{3}{4}$											
CTN WT 3											
CU FT 2											

ACCESSORIES
Tackboard for
Side of Tall Storage

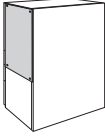
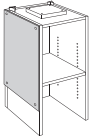

Description	1 Model	Fabric Grade/List Price										
		COM	A	B	C	D	E	F	G	H	I	J
Tackboard for Side of 45" Tall Storage 	<ul style="list-style-type: none"> Culp Montgomery Sterling panel fabric standard Use grade A pricing Other fabrics available, see pages 218-222 or contact Customer Service Mounts to the side of unit Attaches with covered button screws 											
	SS1223TK	\$146	\$157	\$176	\$210	\$255	\$299	\$367	\$440	\$518	\$641	\$787
	<ul style="list-style-type: none"> used with 24" deep x 45" tall storage 											
	D 3/8 W 23 H 12											
	COM YDG 1 CTN WT 2 CU FT 1											
Tackboard for Side of 45" Tall Storage	<ul style="list-style-type: none"> used with 18" deep x 45" tall storage 											
	SS1217TK	\$125	\$134	\$147	\$174	\$206	\$240	\$291	\$346	\$405	\$496	\$606
	D 3/8 W 17 H 12											
	COM YDG 3/4											
	CTN WT 2 CU FT 1											
Tackboard for Side of Side Access Storage 	<ul style="list-style-type: none"> Culp Montgomery Sterling panel fabric standard Use grade A pricing Other fabrics available, see pages 218-222 or contact Customer Service Mounts to the side of unit Attaches with covered button screws 											
	SS2118TK	\$135	\$143	\$157	\$183	\$216	\$249	\$301	\$355	\$414	\$506	\$616
	<ul style="list-style-type: none"> used with 15" deep x 28" tall side access storage cabinet 											
	D 3/8 W 18 H 21											
	COM YDG 3/4											
Tackboard for Side of Side Access Storage	<ul style="list-style-type: none"> used with 15" deep x 25" tall side access storage cabinet 											
	SS1818TK	\$129	\$137	\$151	\$177	\$209	\$243	\$294	\$349	\$408	\$499	\$609
	D 3/8 W 18 H 18											
	COM YDG 3/4											
	CTN WT 3 CU FT 2											
Tackboard for Side of Side Access Storage	<ul style="list-style-type: none"> used with 15" deep x 19" tall side access storage cabinet 											
	SS1218TK	\$126	\$135	\$149	\$175	\$207	\$241	\$292	\$347	\$406	\$497	\$607
	D 3/8 W 18 H 12											
	COM YDG 3/4											
	CTN WT 2 CU FT 1											

To Order, Specify:

- 1 Model number
- 2 Fabric selection: vendor, pattern, color

Order Check List
page 166

Product Specifications
page 40

ACCESSORIES

Tackboard
for Cubby

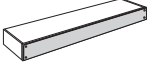
Description	① Model	Fabric Grade/List Price										
		COM	A	B	C	D	E	F	G	H	I	J
Tackboard for Back of Cubby  <ul style="list-style-type: none"> · Culp Montgomery Sterling panel fabric standard · Use grade A pricing · Other fabrics available, see pages 218-222 or contact Customer Service · Mounts to the back side of cubby · Attaches with covered button screws 	SS0684TK	\$249	\$277	\$330	\$425	\$545	\$666	\$855	\$1,057	\$1,271	\$1,607	\$2,010
	· used with 84" wide cubby											
	D ¾ W 84 H 6											
	COM YDG 2 ¾											
	CTN WT 4 CU FT 2											
	SS0678TK	\$237	\$262	\$310	\$396	\$507	\$616	\$787	\$971	\$1,166	\$1,472	\$1,838
· used with 78" wide cubby												
D ¾ W 78 H 6												
COM YDG 2 ½												
CTN WT 3 CU FT 2												
	SS0672TK	\$217	\$240	\$283	\$361	\$459	\$558	\$712	\$877	\$1,053	\$1,328	\$1,657
· used with 72" wide cubby												
D ¾ W 72 H 6												
COM YDG 2 ¾												
CTN WT 3 CU FT 2												
	SS0666TK	\$216	\$239	\$282	\$360	\$458	\$557	\$711	\$876	\$1,052	\$1,327	\$1,656
· used with 66" wide cubby												
D ¾ W 66 H 6												
COM YDG 2 ¾												
CTN WT 3 CU FT 2												
	SS0660TK	\$202	\$222	\$261	\$330	\$417	\$506	\$642	\$789	\$945	\$1,190	\$1,483
· used with 60" wide cubby												
D ¾ W 60 H 6												
COM YDG 2												
CTN WT 3 CU FT 2												

SWISH

ACCESSORIES
Tackboard
for Cubby

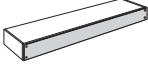
Description	① Model	Fabric Grade/List Price										
		COM	A	B	C	D	E	F	G	H	I	J
Tackboard for Back of Cubby 	<ul style="list-style-type: none"> · Culp Montgomery Sterling panel fabric standard · Use grade A pricing · Other fabrics available, see pages 218-222 or contact Customer Service · Mounts to the back side of cubby · Attaches with covered button screws 											
	SS0654TK · used with 54" wide cubby D ¾ W 54 H 6 COM YDG 1¾ CTN WT 3 CU FT 2	\$189	\$207	\$241	\$301	\$378	\$455	\$575	\$703	\$840	\$1,054	\$1,310
	SS0648TK · used with 48" wide cubby D ¾ W 48 H 6 COM YDG 1¾ CTN WT 2 CU FT 1	\$188	\$206	\$240	\$300	\$377	\$454	\$574	\$702	\$839	\$1,053	\$1,309
	SS0642TK · used with 42" wide cubby D ¾ W 42 H 6 COM YDG 1½ CTN WT 2 CU FT 1	\$172	\$187	\$216	\$267	\$333	\$399	\$502	\$612	\$729	\$913	\$1,132
	SS0636TK · used with 36" wide cubby D ¾ W 36 H 6 COM YDG 1¾ CTN WT 2 CU FT 1	\$155	\$167	\$192	\$235	\$290	\$345	\$430	\$522	\$620	\$772	\$956
	SS0630TK · used with 30" wide cubby D ¾ W 30 H 6 COM YDG 1¾ CTN WT 2 CU FT 1	\$154	\$166	\$191	\$234	\$289	\$344	\$429	\$521	\$619	\$771	\$955

SWISH

To Order, Specify:

- ① Model number
- ② Fabric selection: vendor, pattern, color

Order Check List
page 166

Product Specifications
page 40

ACCESSORIES

Tackboard for Above Surface Storage

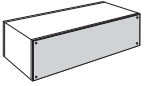
Description	① Model	Fabric Grade/List Price										
		COM	A	B	C	D	E	F	G	H	I	J
Tackboard for Back of 15" High Overhead  <ul style="list-style-type: none"> · Culp Montgomery Sterling panel fabric standard · Use grade A pricing · Other fabrics available, see pages 218-222 or contact Customer Service · Mounts to the back side of overhead · Attaches with covered button screws 	SS1584TK	\$270	\$298	\$351	\$446	\$566	\$687	\$876	\$1,078	\$1,292	\$1,628	\$2,031
	· used with 15" high overhead											
	D ¾ W 84 H 15											
	COM YDG 2 ¼											
	CTN WT 9 CU FT 4											
	SS1578TK	\$256	\$281	\$329	\$415	\$525	\$635	\$806	\$990	\$1,185	\$1,490	\$1,857
· used with 15" high overhead												
D ¾ W 78 H 15												
COM YDG 2 ½												
CTN WT 8 CU FT 4												
	SS1572TK	\$236	\$259	\$302	\$380	\$478	\$577	\$731	\$896	\$1,071	\$1,347	\$1,676
· used with 15" high overhead												
D ¾ W 72 H 15												
COM YDG 2 ¼												
CTN WT 7 CU FT 3												
	SS1566TK	\$235	\$258	\$301	\$378	\$477	\$576	\$730	\$895	\$1,070	\$1,346	\$1,675
· used with 15" high overhead												
D ¾ W 66 H 15												
COM YDG 2 ¼												
CTN WT 7 CU FT 3												
	SS1560TK	\$219	\$239	\$278	\$347	\$434	\$522	\$659	\$806	\$962	\$1,207	\$1,500
· used with 15" high overhead												
D ¾ W 60 H 15												
COM YDG 2												
CTN WT 6 CU FT 3												

SWISH

ACCESSORIES
Tackboard for
Above Surface Storage

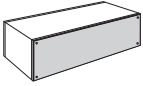
Description	① Model	Fabric Grade/List Price										
		COM	A	B	C	D	E	F	G	H	I	J
Tackboard for Back of 15" High Overhead 	<ul style="list-style-type: none"> · Culp Montgomery Sterling panel fabric standard · Use grade A pricing · Other fabrics available, see pages 218-222 or contact Customer Service · Mounts to the back side of overhead · Attaches with covered button screws 											
	SS1554TK · used with 15" high overhead D $\frac{3}{8}$ W 54 H 15 COM YDG 1 $\frac{3}{4}$ CTN WT 6 CU FT 3	\$203	\$221	\$255	\$314	\$392	\$469	\$588	\$717	\$854	\$1,067	\$1,323
	SS1548TK · used with 15" high overhead D $\frac{3}{8}$ W 48 H 15 COM YDG 1 $\frac{3}{4}$ CTN WT 5 CU FT 2	\$201	\$219	\$252	\$312	\$390	\$467	\$586	\$714	\$852	\$1,065	\$1,321
	SS1542TK · used with 15" high overhead D $\frac{3}{8}$ W 42 H 15 COM YDG 1 $\frac{1}{2}$ CTN WT 5 CU FT 2	\$186	\$202	\$230	\$282	\$348	\$414	\$517	\$626	\$744	\$928	\$1,147
	SS1536TK · used with 15" high overhead D $\frac{3}{8}$ W 36 H 15 COM YDG 1 $\frac{1}{4}$ CTN WT 4 CU FT 2	\$166	\$179	\$203	\$246	\$302	\$356	\$441	\$534	\$632	\$784	\$968
	SS1530TK · used with 15" high overhead D $\frac{3}{8}$ W 30 H 15 COM YDG 1 $\frac{1}{4}$ CTN WT 3 CU FT 2	\$165	\$178	\$202	\$245	\$301	\$355	\$440	\$533	\$630	\$783	\$966

SWISH

To Order, Specify:

- ① Model number
- ② Fabric selection: vendor, pattern, color

Order Check List
page 166

Product Specifications
page 40

ACCESSORIES

Tackboard for Above Surface Storage

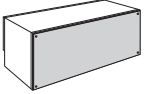
Description	① Model	Fabric Grade/List Price										
		COM	A	B	C	D	E	F	G	H	I	J
Tackboard for Back of 21" High Overhead  <ul style="list-style-type: none"> · Culp Montgomery Sterling panel fabric standard · Use grade A pricing · Other fabrics available, see pages 218-222 or contact Customer Service · Mounts to the back side of overhead · Attaches with covered button screws 	SS2184TK	\$284	\$311	\$365	\$459	\$580	\$701	\$890	\$1,091	\$1,306	\$1,642	\$2,045
	· used with 21" high overhead											
	D ¾ W 84 H 21											
	COM YDG 2 ¼											
	CTN WT 12											
	CU FT 5											
	SS2178TK	\$269	\$294	\$343	\$429	\$539	\$648	\$819	\$1,003	\$1,199	\$1,504	\$1,871
· used with 21" high overhead												
D ¾ W 78 H 21												
COM YDG 2 ½												
CTN WT 11												
CU FT 5												
	SS2172TK	\$248	\$271	\$314	\$392	\$491	\$590	\$744	\$909	\$1,084	\$1,359	\$1,689
· used with 21" high overhead												
D ¾ W 72 H 21												
COM YDG 2 ¼												
CTN WT 10												
CU FT 4												
	SS2166TK	\$245	\$268	\$311	\$389	\$488	\$586	\$741	\$906	\$1,081	\$1,356	\$1,686
· used with 21" high overhead												
D ¾ W 66 H 21												
COM YDG 2 ¼												
CTN WT 9												
CU FT 4												
	SS2160TK	\$230	\$250	\$289	\$359	\$446	\$534	\$670	\$817	\$974	\$1,218	\$1,511
· used with 21" high overhead												
D ¾ W 60 H 21												
COM YDG 2												
CTN WT 9												
CU FT 4												

SWISH

ACCESSORIES
Tackboard for
Above Surface Storage

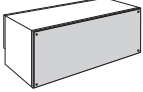
Description	1 Model	Fabric Grade/List Price											
		COM	A	B	C	D	E	F	G	H	I	J	
Tackboard for Back of 21" High Overhead 	<ul style="list-style-type: none"> · Culp Montgomery Sterling panel fabric standard · Use grade A pricing · Other fabrics available, see pages 218-222 or contact Customer Service · Mounts to the back side of overhead · Attaches with covered button screws 	SS2154TK	\$214	\$231	\$265	\$325	\$403	\$479	\$599	\$727	\$865	\$1,078	\$1,334
		· used with 21" high overhead											
		D $\frac{3}{8}$ W 54 H 21											
		COM YDG 1 $\frac{3}{4}$											
		CTN WT 8											
		CU FT 3											
SS2148TK	\$210	\$228	\$262	\$322	\$399	\$476	\$596	\$724	\$861	\$1,075	\$1,331		
· used with 21" high overhead													
D $\frac{3}{8}$ W 48 H 21													
COM YDG 1 $\frac{3}{4}$													
CTN WT 7													
CU FT 3													
SS2142TK	\$196	\$212	\$240	\$291	\$357	\$424	\$527	\$636	\$753	\$937	\$1,157		
· used with 21" high overhead													
D $\frac{3}{8}$ W 42 H 21													
COM YDG 1 $\frac{1}{2}$													
CTN WT 6													
CU FT 3													
SS2136TK	\$175	\$187	\$212	\$255	\$310	\$365	\$450	\$542	\$640	\$792	\$976		
· used with 21" high overhead													
D $\frac{3}{8}$ W 36 H 21													
COM YDG 1 $\frac{1}{4}$													
CTN WT 5													
CU FT 3													
SS2130TK	\$173	\$185	\$209	\$252	\$308	\$363	\$448	\$540	\$638	\$790	\$974		
· used with 21" high overhead													
D $\frac{3}{8}$ W 30 H 21													
COM YDG 1 $\frac{1}{4}$													
CTN WT 5													
CU FT 2													

SWISH

To Order, Specify:

- 1 Model number
- 2 Fabric selection: vendor, pattern, color

Order Check List
page 166

Product Specifications
page 40

Collaborate Order Check List:

Specify:

- 1. Model number
- 2. Laminate color
 - A. Worksurface color
 - B. Panel stretcher color
- 3. Fabric selection - vendor, pattern and color
- 4. Product options
 - A. EC13 cutout
 - B. Undersurface electrical

Example:

SST486CCBP (model #)	HGL (worksurface color)	SD (panel stretcher color)	EG030 (EC13 cutout)
--------------------------------	----------------------------	-------------------------------	------------------------

1. Model number

2. Laminate Color Options:

ALB Alabaster	GRH Graphite
AUT Autumn	HGL High Line
BLO Blonde Echo	SHD Shadow
BBN Bourbon	SHE Shea
BZW Brazilwood	SLG Slate Grey
BBL Bridal Blanco	STU Studio Teak
BRG Brighton	TAU Taupe
DWH Designer White	VIN Vintage
DOV Dove Grey	WLH Walnut Heights

3. Fabric selection - Please supply the following:

- Fabric vendor
- Pattern name
- Pattern color

- Indicate direction of fabric - Railroaded or Up the Roll
- please provide illustration if available

NOTE: Standard application will be Up the Roll

All COM orders must include the following:

- Vendor's name, pattern name and color
- Sample of the fabric attached to order
- Model numbers of items for fabric application
- Special application instructions (e.g., all stripes will be applied front to back unless specified otherwise)
- Customer and purchase order number

Ship prepaid COM material to:

JSI
Attn: COM Dept
932 Mill St.
Jasper, Indiana 47546

Application of fabric:

Railroaded Up the Roll

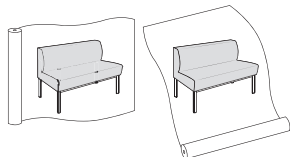

3. Product Options:

- EC13 Cutout:
 - Specify EG030
 - NOTE: EC13 will be located in the center of the top. Panel stretcher will ship with wire management channels for cord management.**
 - NOTE: EC13 units must be ordered separately. Refer to page 214 for more information.**
- Undersurface Electrical:
 - Specify the appropriate number below for the circuit number(s) desired.
 - P1 (circuit 1)
 - P2 (circuit 2)
 - PM (mix circuit 1 and circuit 2)
 - NOTE: Two circuit system requires a hardwire infeed. When Undersurface Electrical is specified the following will be mounted to the underside of the worksurface: two duplex units, two jumper cables and two H block connectors.**
 - NOTE: Infeed cables and additional jumper cables must be ordered separately. Refer to pages 215-217 for additional information.**

All COM orders will ship at standard lead time from receipt of COM.

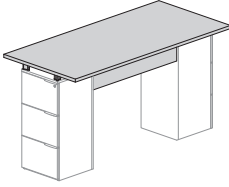
Description	① Model	D	W	H	CTN WT	CU FT	List Price
Collaboration Conference Top 	SST4284CC · four 2 1/4" tall acrylic plenums · eight base unit to worksurface spacers · top requires two base units for support, see page 201 · specify panel stretcher laminate color · optional cutout for EC13, see page 214	42	84	1 3/16	128	15	\$978
	SST4278CC · four 2 1/4" tall acrylic plenums · eight base unit to worksurface spacers · top requires two base units for support, see page 201 · specify panel stretcher laminate color · optional cutout for EC13, see page 214	42	78	1 3/16	119	14	\$928
	SST4272CC · four 2 1/4" tall acrylic plenums · eight base unit to worksurface spacers · top requires two base units for support, see page 201 · specify panel stretcher laminate color · optional cutout for EC13, see page 214	42	72	1 3/16	110	13	\$879
	SST4266CC · four 2 1/4" tall acrylic plenums · eight base unit to worksurface spacers · top requires two base units for support, see page 201 · specify panel stretcher laminate color · optional cutout for EC13, see page 214	42	66	1 3/16	102	12	\$835
	SST4260CC · four 2 1/4" tall acrylic plenums · eight base unit to worksurface spacers · top requires two base units for support, see page 201 · specify panel stretcher laminate color · optional cutout for EC13, see page 214	42	60	1 3/16	93	11	\$789

To Order, Specify:

- ① Model number
- ② Laminate color
 - A. Worksurface color
 - B. Panel stretcher color
- ③ Product Options (see page 196)

② Laminate Color Options:

ALB	Alabaster	GRH	Graphite
AUT	Autumn	HGL	High Line
BLO	Blonde Echo	SHD	Shadow
BBN	Bourbon	SHE	Shea
BZW	Brazilwood	SLG	Slate Grey
BBL	Bridal Blanco	STU	Studio Teak
BRG	Brighton	TAU	Taupe
DWH	Designer White	VIN	Vintage
DOV	Dove Grey	WLH	Walnut Heights

Order Check List
page 196

Product Specifications
page 40

Power and Data Options
page 214

Undersurface Electrical Options
pages 215-217

COLLABORATE

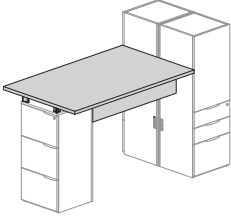
Description	① Model	D	W	H	CTN WT	CU FT	List Price
Integrated Collaboration Conference Top 	SST4872CCBP <ul style="list-style-type: none"> · attaches to back or side of tall storage or wall · mounting bracket included · two 2 1/4" tall acrylic plenums · four base unit to worksurface supports · tall storage unit must be ordered separately, see pages 141-148 · base unit required for non-bracket end, see page 201 · specify panel stretcher laminate color · optional cutout for EC13, see page 214 · optional undersurface electrical includes two duplex units 	48	72	1 3/16	129	14	\$983
							Undersurface Electrical Included List Price \$1,224
	SST4866CCBP <ul style="list-style-type: none"> · attaches to back or side of tall storage or wall · mounting bracket included · two 2 1/4" tall acrylic plenums · four base unit to worksurface supports · tall storage unit must be ordered separately, see pages 141-148 · base unit required for non-bracket end, see page 201 · specify panel stretcher laminate color · optional cutout for EC13, see page 214 · optional undersurface electrical includes two duplex units 	48	66	1 3/16	119	13	\$928
							Undersurface Electrical Included List Price \$1,170
	SST4860CCBP <ul style="list-style-type: none"> · attaches to back or side of tall storage or wall · mounting bracket included · two 2 1/4" tall acrylic plenums · four base unit to worksurface supports · tall storage unit must be ordered separately, see pages 141-148 · base unit required for non-bracket end, see page 201 · specify panel stretcher laminate color · optional cutout for EC13, see page 214 · optional undersurface electrical includes two duplex units 	48	60	1 3/16	108	12	\$872
							Undersurface Electrical Included List Price \$1,112
	SST4854CCBP <ul style="list-style-type: none"> · attaches to back or side of tall storage or wall · mounting bracket included · two 2 1/4" tall acrylic plenums · four base unit to worksurface supports · tall storage unit must be ordered separately, see pages 141-148 · base unit required for non-bracket end, see page 201 · specify panel stretcher laminate color · optional cutout for EC13, see page 214 · optional undersurface electrical includes two duplex units 	48	54	1 3/16	99	11	\$817
							Undersurface Electrical Included List Price \$1,060

SWISH

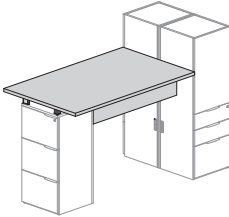
Description	1 Model	D	W	H	CTN WT	CU FT	List Price	
Integrated Collaboration Conference Top 	SST3672CCBP <ul style="list-style-type: none"> attaches to back or side of tall storage or wall mounting bracket included two 2 1/4" tall acrylic plenums four base unit to worksurface supports tall storage unit must be ordered separately, see pages 141-148 base unit required for non-bracket end, see page 201 specify panel stretcher laminate color optional cutout for EC13, see page 214 optional undersurface electrical includes two duplex units 	36	72	1 3/16	101	11	\$850	
		Undersurface Electrical Included List Price						\$1,092
	SST3666CCBP <ul style="list-style-type: none"> attaches to back or side of tall storage or wall mounting bracket included two 2 1/4" tall acrylic plenums four base unit to worksurface supports tall storage unit must be ordered separately, see pages 141-148 base unit required for non-bracket end, see page 201 specify panel stretcher laminate color optional cutout for EC13, see page 214 optional undersurface electrical includes two duplex units 	36	66	1 3/16	93	10	\$808	
		Undersurface Electrical Included List Price						\$1,050
	SST3660CCBP <ul style="list-style-type: none"> attaches to back or side of tall storage or wall mounting bracket included two 2 1/4" tall acrylic plenums four base unit to worksurface supports tall storage unit must be ordered separately, see pages 141-148 base unit required for non-bracket end, see page 201 specify panel stretcher laminate color optional cutout for EC13, see page 214 optional undersurface electrical includes two duplex units 	36	60	1 3/16	85	9	\$762	
	Undersurface Electrical Included List Price						\$1,002	
SST3654CCBP <ul style="list-style-type: none"> attaches to back or side of tall storage or wall mounting bracket included two 2 1/4" tall acrylic plenums four base unit to worksurface supports tall storage unit must be ordered separately, see pages 141-148 base unit required for non-bracket end, see page 201 specify panel stretcher laminate color optional cutout for EC13, see page 214 optional undersurface electrical includes two duplex units 	36	54	1 3/16	78	8	\$719		
	Undersurface Electrical Included List Price						\$960	



To Order, Specify:

- 1 Model number
- 2 Laminate color
 - A. Worksurface color
 - B. Panel stretcher color
- 3 Product Options (see page 196)

2 Laminate Color Options:

ALB Alabaster	GRH Graphite
AUT Autumn	HGL High Line
BLO Blonde Echo	SHD Shadow
BBN Bourbon	SHE Shea
BZW Brazilwood	SLG Slate Grey
BBL Bridal Blanco	STU Studio Teak
BRG Brighton	TAU Taupe
DWH Designer White	VIN Vintage
DOV Dove Grey	WLH Walnut Heights

Order Check List



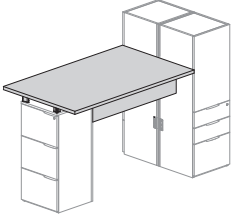

- page 196
- Product Specifications**
page 40
- Power and Data Options**
page 214
- Undersurface Electrical Options**
pages 215-217

COLLABORATE

Description	① Model	D	W	H	CTN WT	CU FT	List Price
Integrated Collaboration Conference Top 	SST3072CCBP <ul style="list-style-type: none"> · attaches to back or side of tall storage or wall · mounting bracket included · two 2 1/4" tall acrylic plenums · four base unit to worksurface supports · tall storage unit must be ordered separately, see pages 141-148 · base unit required for non-bracket end, see page 201 · specify panel stretcher laminate color · optional cutout for EC13, see page 214 · optional undersurface electrical includes two duplex units 	30	72	1 3/16	87	9	\$783
							Undersurface Electrical Included List Price \$1,024
	SST3066CCBP <ul style="list-style-type: none"> · attaches to back or side of tall storage or wall · mounting bracket included · two 2 1/4" tall acrylic plenums · four base unit to worksurface supports · tall storage unit must be ordered separately, see pages 141-148 · base unit required for non-bracket end, see page 201 · specify panel stretcher laminate color · optional cutout for EC13, see page 214 · optional undersurface electrical includes two duplex units 	30	66	1 3/16	80	8	\$762
							Undersurface Electrical Included List Price \$1,002
	SST3060CCBP <ul style="list-style-type: none"> · attaches to back or side of tall storage or wall · mounting bracket included · two 2 1/4" tall acrylic plenums · four base unit to worksurface supports · tall storage unit must be ordered separately, see pages 141-148 · base unit required for non-bracket end, see page 201 · specify panel stretcher laminate color · optional cutout for EC13, see page 214 · optional undersurface electrical includes two duplex units 	30	60	1 3/16	74	8	\$704
							Undersurface Electrical Included List Price \$947
	SST3054CCBP <ul style="list-style-type: none"> · attaches to back or side of tall storage or wall · mounting bracket included · two 2 1/4" tall acrylic plenums · four base unit to worksurface supports · tall storage unit must be ordered separately, see pages 141-148 · base unit required for non-bracket end, see page 201 · specify panel stretcher laminate color · optional cutout for EC13, see page 214 · optional undersurface electrical includes two duplex units 	30	54	1 3/16	67	7	\$666
							Undersurface Electrical Included List Price \$909

SWISH

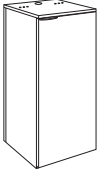
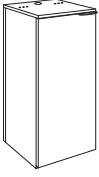
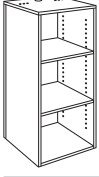
COLLABORATE

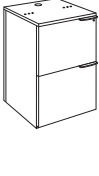
Description		① Model	D	W	H	CTN WT	CU FT	List Price
	Stand Up Height Collaboration Table Base · top grommet · wire access through bottom of pedestal · pedestal front locking · file/file/file pedestal · letter width pedestal · cannot be used as freestanding pedestal	SS1818-38FFF	18	18	37 ¹³ / ₁₆	138	10	\$945
	Stand Up Height Collaboration Table Base · top grommet · wire access through bottom of pedestal · pedestal front locking · non-locking door standard; locking door available, specify and add \$105 list · hinged door · file/file pedestal · letter width pedestal · cannot be used as freestanding pedestal	Right SS1818-38HRFF	18	18	37 ¹³ / ₁₆	133	10	\$929
		Left SS1818-38HLFF	18	18	37 ¹³ / ₁₆	133	10	\$929
	Stand Up Height Collaboration Table Base · non-locking door standard; locking door available, specify and add \$105 list · hinged door · letter width pedestal	Right SS1818-38HR	18	18	37 ¹³ / ₁₆	105	10	\$844
		Left SS1818-38HL	18	18	37 ¹³ / ₁₆	105	10	\$844
	Stand Up Height Collaboration Table Base · open storage · two adjustable shelves	SS1818-38OS	18	18	37 ¹³ / ₁₆	92	10	\$755
	Executive Height - Box/Box/File · top grommet standard · wire access through bottom of pedestal · collaboration top must be ordered separately, see pages 197-200 · pedestal front locking · box/box/file pedestal · letter width pedestal · cannot be used as freestanding pedestal	SS1818MBBF	18	18	26			\$796
	Executive Height - File/File · top grommet standard · wire access through bottom of pedestal · collaboration top must be ordered separately, see pages 197-200 · pedestal front locking · file/file pedestal · letter width pedestal · cannot be used as freestanding pedestal	SS1818MFF	18	18	26			\$776

SWISH

To Order, Specify:

- ① Model number
- ② Laminate color
 - A. Worksurface color
 - B. Panel stretcher color
- ③ Product Options (see page 196)

② Laminate Color Options:

ALB	Alabaster	GRH	Graphite
AUT	Autumn	HGL	High Line
BLO	Blonde Echo	SHD	Shadow
BBN	Bourbon	SHE	Shea
BZW	Brazilwood	SLG	Slate Grey
BBL	Bridal Bianco	STU	Studio Teak
BRG	Brighton	TAU	Taupe
DWH	Designer White	VIN	Vintage
DOV	Dove Grey	WLH	Walnut Heights

Order Check List
page 196

Product Specifications
page 40

Power and Data Options
page 214

Undersurface Electrical Options
pages 215-217

COLLABORATE

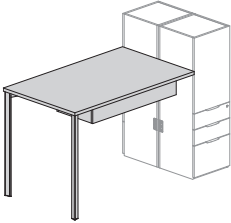
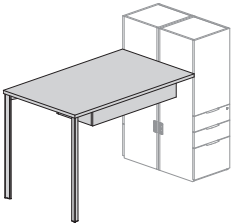
Description	① Model	D	W	H	CTN WT	CU FT	List Price	
Integrated Collaboration Conference Table Stand Up Height 	SS4860CCBL-42 · one end attaches to back or side of tall storage or wall · mounting bracket and two stand up height floor legs included · tall storage unit must be ordered separately, see pages 141-148 · specify panel stretcher laminate color · optional cutout for EC13, see page 214 · optional undersurface electrical includes two duplex units	48	60	42	120	17	\$1,214	
	Undersurface Electrical Included List Price							\$1,457
	SS4854CCBL-42 · one end attaches to back or side of tall storage or wall · mounting bracket and two stand up height floor legs included · tall storage unit must be ordered separately, see pages 141-148 · specify panel stretcher laminate color · optional cutout for EC13, see page 214 · optional undersurface electrical includes two duplex units	48	54	42	110	15	\$1,158	
	Undersurface Electrical Included List Price							\$1,398
	SS4848CCBL-42 · one end attaches to back or side of tall storage or wall · mounting bracket and two stand up height floor legs included · tall storage unit must be ordered separately, see pages 141-148 · specify panel stretcher laminate color · optional cutout for EC13, see page 214 · optional undersurface electrical includes two duplex units	48	48	42	99	13	\$1,106	
	Undersurface Electrical Included List Price							\$1,349
	SS4842CCBL-42 · one end attaches to back or side of tall storage or wall · mounting bracket and two stand up height floor legs included · tall storage unit must be ordered separately, see pages 141-148 · specify panel stretcher laminate color · optional cutout for EC13, see page 214 · optional undersurface electrical includes two duplex units	48	42	42	89	11	\$1,057	
	Undersurface Electrical Included List Price							\$1,297
	Integrated Collaboration Conference Table Stand Up Height 	SS3660CCBL-42 · one end attaches to back or side of tall storage or wall · mounting bracket and two stand up height floor legs included · tall storage unit must be ordered separately, see pages 141-148 · specify panel stretcher laminate color · optional cutout for EC13, see page 214 · optional undersurface electrical includes two duplex units	36	60	42	97	13	\$1,107
		Undersurface Electrical Included List Price						
SS3654CCBL-42 · one end attaches to back or side of tall storage or wall · mounting bracket and two stand up height floor legs included · tall storage unit must be ordered separately, see pages 141-148 · specify panel stretcher laminate color · optional cutout for EC13, see page 214 · optional undersurface electrical includes two duplex units		36	54	42	87	11	\$1,060	
Undersurface Electrical Included List Price							\$1,302	
SS3648CCBL-42 · one end attaches to back or side of tall storage or wall · mounting bracket and two stand up height floor legs included · tall storage unit must be ordered separately, see pages 141-148 · specify panel stretcher laminate color · optional cutout for EC13, see page 214 · optional undersurface electrical includes two duplex units		36	48	42	81	10	\$1,020	
Undersurface Electrical Included List Price							\$1,260	
SS3642CCBL-42 · one end attaches to back or side of tall storage or wall · mounting bracket and two stand up height floor legs included · tall storage unit must be ordered separately, see pages 141-148 · specify panel stretcher laminate color · optional cutout for EC13, see page 214 · optional undersurface electrical includes two duplex units		36	42	42	73	9	\$980	
Undersurface Electrical Included List Price							\$1,221	

COLLABORATE

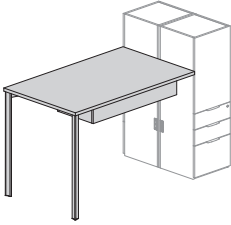
Description	1 Model	D	W	H	CTN WT	CU FT	List Price
Integrated Collaboration Conference Table Stand Up Height 	SS3060CCBL-42 · one end attaches to back or side of tall storage or wall · mounting bracket and two stand up height floor legs included · tall storage unit must be ordered separately, see pages 141-148 · specify panel stretcher laminate color · optional cutout for EC13, see page 214 · optional undersurface electrical includes two duplex units	30	60	42	85	11	\$1,050 Undersurface Electrical Included List Price \$1,291
	SS3054CCBL-42 · one end attaches to back or side of tall storage or wall · mounting bracket and two stand up height floor legs included · tall storage unit must be ordered separately, see pages 141-148 · specify panel stretcher laminate color · optional cutout for EC13, see page 214 · optional undersurface electrical includes two duplex units	30	54	42	78	10	\$1,007 Undersurface Electrical Included List Price \$1,249
	SS3048CCBL-42 · one end attaches to back or side of tall storage or wall · mounting bracket and two stand up height floor legs included · tall storage unit must be ordered separately, see pages 141-148 · specify panel stretcher laminate color · optional cutout for EC13, see page 214 · optional undersurface electrical includes two duplex units	30	48	42	72	9	\$973 Undersurface Electrical Included List Price \$1,214
	SS3042CCBL-42 · one end attaches to back or side of tall storage or wall · mounting bracket and two stand up height floor legs included · tall storage unit must be ordered separately, see pages 141-148 · specify panel stretcher laminate color · optional cutout for EC13, see page 214 · optional undersurface electrical includes two duplex units	30	42	42	65	8	\$939 Undersurface Electrical Included List Price \$1,180

SWISH

To Order, Specify:

- 1 Model number
- 2 Laminate color
 - A. Worksurface color
 - B. Panel stretcher color
- 3 Product Options (see page 196)

2 Laminate Color Options:

ALB Alabaster	GRH Graphite
AUT Autumn	HGL High Line
BLO Blonde Echo	SHD Shadow
BBN Bourbon	SHE Shea
BZW Brazilwood	SLG Slate Grey
BBL Bridal Blanco	STU Studio Teak
BRG Brighton	TAU Taupe
DWH Designer White	VIN Vintage
DOV Dove Grey	WLH Walnut Heights

Order Check List

page 196

Product Specifications

page 40

Power and Data Options

page 214

Undersurface Electrical Options

pages 215-217

COLLABORATE

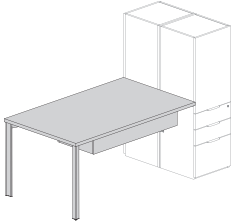
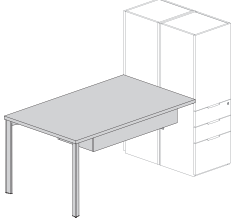
Description	① Model	D	W	H	CTN WT	CU FT	List Price	
Integrated Collaboration Conference Table Executive Height 	SS4860CCBL-29 · one end attaches to back or side of tall storage or wall · mounting bracket and two executive height floor legs included · tall storage unit must be ordered separately, see pages 141-148 · specify panel stretcher laminate color · optional cutout for EC13, see page 214 · optional undersurface electrical includes two duplex units	48	60	29 3/8	118	17	\$1,159	
	Undersurface Electrical Included List Price							\$1,399
	SS4854CCBL-29 · one end attaches to back or side of tall storage or wall · mounting bracket and two executive height floor legs included · tall storage unit must be ordered separately, see pages 141-148 · specify panel stretcher laminate color · optional cutout for EC13, see page 214 · optional undersurface electrical includes two duplex units	48	54	29 3/8	108	15	\$1,100	
	Undersurface Electrical Included List Price							\$1,342
	SS4848CCBL-29 · one end attaches to back or side of tall storage or wall · mounting bracket and two executive height floor legs included · tall storage unit must be ordered separately, see pages 141-148 · specify panel stretcher laminate color · optional cutout for EC13, see page 214 · optional undersurface electrical includes two duplex units	48	48	29 3/8	97	13	\$1,050	
Undersurface Electrical Included List Price							\$1,291	
SS4842CCBL-29 · one end attaches to back or side of tall storage or wall · mounting bracket and two executive height floor legs included · tall storage unit must be ordered separately, see pages 141-148 · specify panel stretcher laminate color · optional cutout for EC13, see page 214 · optional undersurface electrical includes two duplex units	48	42	29 3/8	87	11	\$999		
Undersurface Electrical Included List Price							\$1,242	
Integrated Collaboration Conference Table Executive Height 	SS3660CCBL-29 · one end attaches to back or side of tall storage or wall · mounting bracket and two executive height floor legs included · tall storage unit must be ordered separately, see pages 141-148 · specify panel stretcher laminate color · optional cutout for EC13, see page 214 · optional undersurface electrical includes two duplex units	36	60	29 3/8	95	13	\$1,052	
	Undersurface Electrical Included List Price							\$1,292
	SS3654CCBL-29 · one end attaches to back or side of tall storage or wall · mounting bracket and two executive height floor legs included · tall storage unit must be ordered separately, see pages 141-148 · specify panel stretcher laminate color · optional cutout for EC13, see page 214 · optional undersurface electrical includes two duplex units	36	54	29 3/8	87	11	\$1,002	
	Undersurface Electrical Included List Price							\$1,245
	SS3648CCBL-29 · one end attaches to back or side of tall storage or wall · mounting bracket and two executive height floor legs included · tall storage unit must be ordered separately, see pages 141-148 · specify panel stretcher laminate color · optional cutout for EC13, see page 214 · optional undersurface electrical includes two duplex units	36	48	29 3/8	79	10	\$962	
Undersurface Electrical Included List Price							\$1,205	
SS3642CCBL-29 · one end attaches to back or side of tall storage or wall · mounting bracket and two executive height floor legs included · tall storage unit must be ordered separately, see pages 141-148 · specify panel stretcher laminate color · optional cutout for EC13, see page 214 · optional undersurface electrical includes two duplex units	36	42	29 3/8	71	9	\$922		
Undersurface Electrical Included List Price							\$1,165	

SWISH

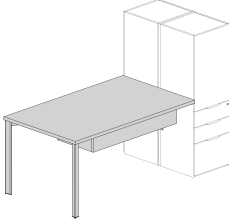
Description	1 Model	D	W	H	CTN WT	CU FT	List Price
Integrated Collaboration Conference Table Executive Height 	SS3060CCBL-29 · one end attaches to back or side of tall storage or wall · mounting bracket and two executive height floor legs included · tall storage unit must be ordered separately, see pages 141-148 · specify panel stretcher laminate color · optional cutout for EC13, see page 214 · optional undersurface electrical includes two duplex units	30	60	29 3/8	83	11	\$993 Undersurface Electrical Included List Price \$1,235
	SS3054CCBL-29 · one end attaches to back or side of tall storage or wall · mounting bracket and two executive height floor legs included · tall storage unit must be ordered separately, see pages 141-148 · specify panel stretcher laminate color · optional cutout for EC13, see page 214 · optional undersurface electrical includes two duplex units	30	54	29 3/8	76	10	\$951 Undersurface Electrical Included List Price \$1,193
	SS3048CCBL-29 · one end attaches to back or side of tall storage or wall · mounting bracket and two executive height floor legs included · tall storage unit must be ordered separately, see pages 141-148 · specify panel stretcher laminate color · optional cutout for EC13, see page 214 · optional undersurface electrical includes two duplex units	30	48	29 3/8	70	9	\$916 Undersurface Electrical Included List Price \$1,159
	SS3042CCBL-29 · one end attaches to back or side of tall storage or wall · mounting bracket and two executive height floor legs included · tall storage unit must be ordered separately, see pages 141-148 · specify panel stretcher laminate color · optional cutout for EC13, see page 214 · optional undersurface electrical includes two duplex units	30	42	29 3/8	63	8	\$881 Undersurface Electrical Included List Price \$1,124

SWISH

To Order, Specify:

- 1 Model number
- 2 Laminate color
 - A. Worksurface color
 - B. Panel stretcher color
- 3 Product Options (see page 196)

2 Laminate Color Options:

ALB Alabaster	GRH Graphite
AUT Autumn	HGL High Line
BLO Blonde Echo	SHD Shadow
BBN Bourbon	SHE Shea
BZW Brazilwood	SLG Slate Grey
BBL Bridal Blanco	STU Studio Teak
BRG Brighton	TAU Taupe
DWH Designer White	VIN Vintage
DOV Dove Grey	WLH Walnut Heights

Order Check List
page 196

Product Specifications
page 40



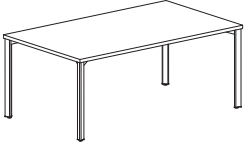
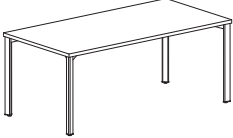
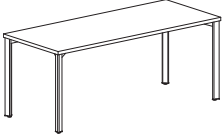
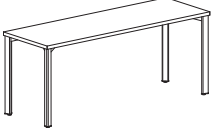

Power and Data Options
page 214

Undersurface Electrical Options
pages 215-217

COLLABORATE

Description	Model	D	W	H	CTN WT	CU FT	List Price
Work Table 	SS4848T-29 · ships modular in two cartons	48	48	29 3/8	89	13	\$1,195
	SS4242T-29 · ships modular in two cartons	42	42	29 3/8	72	11	\$1,108
	SS3636T-29 · ships modular in two cartons	36	36	29 3/8	57	10	\$1,032
Work Table 	SS4278T-29 · ships modular in two cartons	42	78	29 3/8	124	17	\$1,439
	SS4272T-29 · ships modular in two cartons	42	72	29 3/8	116	16	\$1,394
	SS4266T-29 · ships modular in two cartons	42	66	29 3/8	107	14	\$1,349
	SS4260T-29 · ships modular in two cartons	42	60	29 3/8	99	14	\$1,305
Work Table 	SS3678T-29 · ships modular in two cartons	36	78	29 3/8	109	15	\$1,365
	SS3672T-29 · ships modular in two cartons	36	72	29 3/8	102	14	\$1,326
	SS3666T-29 · ships modular in two cartons	36	66	29 3/8	95	13	\$1,286
	SS3660T-29 · ships modular in two cartons	36	60	29 3/8	87	13	\$1,247
Work Table 	SS3078T-29 · ships modular in two cartons	30	78	29 3/8	94	13	\$1,293
	SS3072T-29 · ships modular in two cartons	30	72	29 3/8	88	13	\$1,258
	SS3066T-29 · ships modular in two cartons	30	66	29 3/8	82	12	\$1,223
	SS3060T-29 · ships modular in two cartons	30	60	29 3/8	76	11	\$1,188
Work Table 	SS2478T-29 · ships modular in two cartons	24	78	29 3/8	80	12	\$1,221
	SS2472T-29 · ships modular in two cartons	24	72	29 3/8	75	12	\$1,192
	SS2466T-29 · ships modular in two cartons	24	66	29 3/8	66	11	\$1,162
	SS2460T-29 · ships modular in two cartons	24	60	29 3/8	61	10	\$1,132

SWISH

Description	① Model	D	W	H	CTN WT	CU FT	List Price
Squircle Pneumatic Adjustable Height Table 	SS36SQCL-PN · pneumatic lift height adjustability · release handle under top activates adjustability · table adjusts from 27 1/2" to 44 1/2" · ships assembled	36	36	29 7/16	75	22	\$2,398
	SS30SQCL-PN · pneumatic lift height adjustability · release handle under top activates adjustability · table adjusts from 27 1/2" to 44 1/2" · ships assembled	30	30	29 7/16	62	16	\$2,252
Squircle Ratcheting Adjustable Height Table 	SS36SQCL-RA · ratchet height adjustability · lift to adjust top · table adjusts from 27 3/8" to 36 3/4" · ships assembled	36	36	29 7/16	75	22	\$1,783
	SS30SQCL-RA · ratchet height adjustability · lift to adjust top · table adjusts from 27 3/8" to 36 3/4" · ships assembled	30	30	29 7/16	62	16	\$1,682
Squircle Pneumatic Adjustable Height Table with Casters 	SS36SQCL-PN-CAST · locking casters · pneumatic lift height adjustability · release handle under top activates adjustability · table adjusts from 30 1/2" to 47 1/2" · ships assembled	36	36	29 7/16	75	22	\$2,534
	SS30SQCL-PN-CAST · locking casters · pneumatic lift height adjustability · release handle under top activates adjustability · table adjusts from 30 1/2" to 47 1/2" · ships assembled	30	30	29 7/16	62	16	\$2,388
Squircle Ratcheting Adjustable Height Table with Casters 	SS36SQCL-RA-CAST · locking casters · lift to adjust top · table adjusts from 27 3/8" to 36 3/4" · ships assembled	36	36	29 7/16	75	22	\$1,920
	SS30SQCL-RA-CAST · locking casters · lift to adjust top · table adjusts from 27 3/8" to 36 3/4" · ships assembled	30	30	29 7/16	62	16	\$1,817

To Order, Specify:

- ① Model number
- ② Laminate color





② Laminate Color Options:

ALB Alabaster	GRH Graphite
AUT Autumn	HGL High Line
BLO Blonde Echo	SHD Shadow
BBN Bourbon	SHE Shea
BZW Brazilwood	SLG Slate Grey
BBL Bridal Blanco	STU Studio Teak
BRG Brighton	TAU Taupe
DWH Designer White	VIN Vintage
DOV Dove Grey	WLH Walnut Heights



Order Check List
page 196

Product Specifications
page 40

COLLABORATE

Description	① Model	D	W	H	CTN WT	CU FT	List Price
Round Pneumatic Adjustable Height Table 	SS36ROUN-PN · pneumatic lift height adjustability · release handle under top activates adjustability · table adjusts from 27 1/2" to 44 1/2" · ships assembled	36	36	29 7/16	72	22	\$2,398
	SS30ROUN-PN · pneumatic lift height adjustability · release handle under top activates adjustability · table adjusts from 27 1/2" to 44 1/2" · ships assembled	30	30	29 7/16	60	16	\$2,252
Round Ratcheting Adjustable Height Table 	SS36ROUN-RA · ratchet height adjustability · lift to adjust top · table adjusts from 27 3/8" to 36 3/4" · ships assembled	36	36	29 7/16	72	22	\$1,783
	SS30ROUN-RA · ratchet height adjustability · lift to adjust top · table adjusts from 27 3/8" to 36 3/4" · ships assembled	30	30	29 7/16	60	16	\$1,682
Round Pneumatic Adjustable Height Table with Casters 	SS36ROUN-PN-CAST · locking casters · pneumatic lift height adjustability · release handle under top activates adjustability · table adjusts from 30 1/2" to 47 1/2" · ships assembled	36	36	29 7/16	72	22	\$2,534
	SS30ROUN-PN-CAST · locking casters · pneumatic lift height adjustability · release handle under top activates adjustability · table adjusts from 30 1/2" to 47 1/2" · ships assembled	30	30	29 7/16	60	16	\$2,388
Round Ratcheting Adjustable Height Table with Casters 	SS36ROUN-RA-CAST · locking casters · lift to adjust top · table adjusts from 27 3/8" to 36 3/4" · ships assembled	36	36	29 7/16	72	22	\$1,920
	SS30ROUN-RA-CAST · locking casters · lift to adjust top · table adjusts from 27 3/8" to 36 3/4" · ships assembled	30	30	29 7/16	60	16	\$1,817

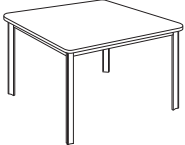
COLLABORATE

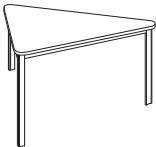
Description	① Model	D	W	H	CTN WT	CU FT	List Price
Rectangular Lounge Table 	SS2448T-23 · ships assembled	24	48	23	39	19	\$952
Square Lounge Table 	SS4242T-23 · ships assembled	42	42	23	53	29	\$1,466
Square Lounge Table 	SS3636T-17 · ships assembled	36	36	17	52	16	\$1,111
	SS3030T-17 · ships assembled	30	30	17	33	12	\$1,025
	SS2424T-17 · ships assembled	24	24	17	26	8	\$869
Triangular Lounge Table 	SS48TRI-23 · ships assembled	48	48	23	64	37	\$1,404
	SS36TRI-23 · ships assembled	36	36	23	42	21	\$1,161

SWISH

To Order, Specify:

- ① Model number
- ② Laminate color

② Laminate Color Options:

ALB	Alabaster	GRH	Graphite
AUT	Autumn	HGL	High Line
BLO	Blonde Echo	SHD	Shadow
BBN	Bourbon	SHE	Shea
BZW	Brazilwood	SLG	Slate Grey
BBL	Bridal Blanco	STU	Studio Teak
BRG	Brighton	TAU	Taupe
DWH	Designer White	VIN	Vintage
DOV	Dove Grey	WLH	Walnut Heights

Order Check List
page 196

Product Specifications
page 40

COLLABORATE

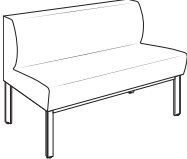
Description	① Model	Fabric Grade/List Price													
		COM	A	B	C	D	E	F	G	H	I	J	L1	L2	
Lounge Seating 	SS2448UBB	\$1,158	\$1,188	\$1,246	\$1,349	\$1,481	\$1,612	\$1,818	\$2,037	\$2,273	\$2,639	\$3,079	\$2,199	\$2,463	
	· upholstered backed bench · ships assembled														
	D 24 W 48 H 29 SD 19 SW 48 SH 17 COM YDG 3 COL SQ FT 70 CTN WT 55 CU FT 24														
	<hr/>														
		SS2436UBB	\$1,087	\$1,118	\$1,175	\$1,278	\$1,411	\$1,542	\$1,748	\$1,967	\$2,202	\$2,569	\$3,009	\$2,129	\$2,392
	· upholstered backed bench · ships assembled														
	D 24 W 36 H 29 SD 19 SW 36 SH 17 COM YDG 3 COL SQ FT 60 CTN WT 45 CU FT 18														
	<hr/>														
		SS2430UBB	\$1,058	\$1,088	\$1,146	\$1,249	\$1,381	\$1,512	\$1,718	\$1,938	\$2,173	\$2,539	\$2,979	\$2,099	\$2,363
	· upholstered backed bench · ships assembled														
	D 24 W 30 H 29 SD 19 SW 30 SH 17 COM YDG 3 COL SQ FT 60 CTN WT 34 CU FT 15														
	<hr/>														
		SS2424UBB	\$977	\$997	\$1,036	\$1,105	\$1,192	\$1,280	\$1,417	\$1,564	\$1,720	\$1,965	\$2,258	\$1,671	\$1,847
	· upholstered backed bench · ships assembled														
	D 24 W 24 H 29 SD 19 SW 24 SH 17 COM YDG 2 COL SQ FT 50 CTN WT 29 CU FT 13														

SWISH

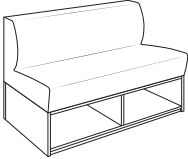
Description	① Model	Fabric Grade/List Price												
		COM	A	B	C	D	E	F	G	H	I	J	L1	L2
Lounge Seating with Open Shelf 	SS2448UBBOS · upholstered backed bench · two open shelves below seat · specify shelf laminate color · inside shelf dimensions 22 7/16" D x 22 7/8" W x 8 3/16"H · ships assembled D 24 W 48 H 29 SD 19 SW 48 SH 17 COM YDG 3 COL SQ FT 70 CTN WT 118 CU FT 24	\$1,187	\$1,217	\$1,275	\$1,378	\$1,510	\$1,642	\$1,847	\$2,067	\$2,302	\$2,669	\$3,108	\$2,229	\$2,492
	SS2436UBBOS · upholstered backed bench · two open shelves below seat · specify shelf laminate color · inside shelf dimensions 22 7/16" D x 16 7/8" W x 8 3/16"H · ships assembled D 24 W 36 H 29 SD 19 SW 36 SH 17 COM YDG 3 COL SQ FT 60 CTN WT 89 CU FT 18	\$1,073	\$1,103	\$1,161	\$1,264	\$1,396	\$1,527	\$1,733	\$1,952	\$2,188	\$2,554	\$2,994	\$2,114	\$2,378
SS2430UBBOS · upholstered backed bench · two open shelves below seat · specify shelf laminate color · inside shelf dimensions 22 7/16" D x 13 7/8" W x 8 3/16"H · ships assembled D 24 W 30 H 29 SD 19 SW 30 SH 17 COM YDG 3 COL SQ FT 60 CTN WT 75 CU FT 15	\$1,033	\$1,063	\$1,121	\$1,224	\$1,356	\$1,487	\$1,693	\$1,913	\$2,148	\$2,514	\$2,954	\$2,074	\$2,338	
SS2424UBBOS · upholstered backed bench · open shelf below seat · specify shelf laminate color · inside shelf dimensions 22 7/16" D x 22 1/2" W x 8 3/16"H · ships assembled D 24 W 24 H 29 SD 19 SW 24 SH 17 COM YDG 2 COL SQ FT 50 CTN WT 60 CU FT 13	\$961	\$981	\$1,020	\$1,089	\$1,176	\$1,265	\$1,401	\$1,548	\$1,705	\$1,949	\$2,242	\$1,655	\$1,832	

To Order, Specify:

- ① Model number
- ② Laminate color
- ③ Fabric selection: vendor, pattern, color

② Laminate Color Options:

ALB Alabaster	GRH Graphite
AUT Autumn	HGL High Line
BLO Blonde Echo	SHD Shadow
BBN Bourbon	SHE Shea
BZW Brazilwood	SLG Slate Grey
BBL Bridal Blanco	STU Studio Teak
BRG Brighton	TAU Taupe
DWH Designer White	VIN Vintage
DOV Dove Grey	WLH Walnut Heights

Order Check List

page 196

Product Specifications

page 40

COLLABORATE

DESCRIPTION	① MODEL	FABRIC GRADE/LIST PRICE												
		COM	A	B	C	D	E	F	G	H	I	J	L1	L2
MOBILE PEDESTAL 	SS2018MP · box/file only · upholstered cushion top · locking casters · pedestal front locking · ships assembled D 20 W 18 H 24 ½ CTN WT 85 COM YDG 1 CU FT 6	\$1,129	\$1,140	\$1,159	\$1,193	\$1,237	\$1,281	\$1,350	\$1,423	\$1,501	\$1,624	\$1,770	\$1,477	\$1,565

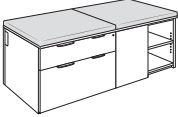
Description	① Model	Fabric Grade/List Price												
		COM	A	B	C	D	E	F	G	H	I	J	L1	L2
24" Deep Seat Cushions 	SS2436CUSH · rubber anti-slip feet · removable cushion · not permanently installed allowing flexibility in position D 24 W 36 H 1 ½ COM YDG 1 ½ COL SQ FT 30 CTN WT 14 CU FT 3	\$245	\$261	\$289	\$341	\$407	\$473	\$576	\$685	\$803	\$986	\$1,206	\$766	\$898

SS2430CUSH · rubber anti-slip feet · removable cushion · not permanently installed allowing flexibility in position D 24 W 30 H 1 ½ COM YDG 1 ¼ COL SQ FT 25 CTN WT 12 CU FT 2	\$235	\$247	\$271	\$314	\$370	\$425	\$510	\$602	\$700	\$852	\$1,036	\$669	\$779
---	-------	-------	-------	-------	-------	-------	-------	-------	-------	-------	---------	-------	-------

SS2424CUSH · rubber anti-slip feet · removable cushion · not permanently installed allowing flexibility in position D 24 W 24 H 1 ½ COM YDG 1 ¼ COL SQ FT 25 CTN WT 10 CU FT 2	\$220	\$233	\$257	\$300	\$355	\$410	\$495	\$587	\$685	\$837	\$1,021	\$655	\$764
---	-------	-------	-------	-------	-------	-------	-------	-------	-------	-------	---------	-------	-------

SS2418CUSH · rubber anti-slip feet · removable cushion · not permanently installed allowing flexibility in position D 24 W 18 H 1 ½ COM YDG 1 COL SQ FT 20 CTN WT 7 CU FT 2	\$207	\$218	\$237	\$271	\$315	\$360	\$428	\$501	\$579	\$702	\$848	\$555	\$643
--	-------	-------	-------	-------	-------	-------	-------	-------	-------	-------	-------	-------	-------

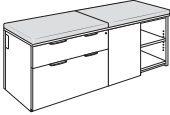
Description	① Model	Fabric Grade/List Price												
		COM	A	B	C	D	E	F	G	H	I	J	L1	L2
18" Deep Seat Cushions 	SS1836CUSH · rubber anti-slip feet · removable cushion · not permanently installed allowing flexibility in position D 18 W 36 H 1 1/2 COM YDG 1 1/2 COL SQ FT 28 CTN WT 13 CU FT 2	\$229	\$245	\$273	\$325	\$391	\$457	\$560	\$669	\$787	\$971	\$1,190	\$750	\$882
	SS1830CUSH · rubber anti-slip feet · removable cushion · not permanently installed allowing flexibility in position D 18 W 30 H 1 1/2 COM YDG 1 1/4 COL SQ FT 23 CTN WT 11 CU FT 2	\$219	\$231	\$256	\$299	\$354	\$409	\$494	\$586	\$684	\$836	\$1,020	\$654	\$763
	SS1824CUSH · rubber anti-slip feet · removable cushion · not permanently installed allowing flexibility in position D 18 W 24 H 1 1/2 COM YDG 1 1/4 COL SQ FT 20 CTN WT 9 CU FT 2	\$208	\$221	\$245	\$288	\$344	\$398	\$483	\$576	\$674	\$826	\$1,010	\$643	\$752
	SS1818CUSH · rubber anti-slip feet · removable cushion · not permanently installed allowing flexibility in position D 18 W 18 H 1 1/2 COM YDG 1 COL SQ FT 15 CTN WT 6 CU FT 1	\$199	\$209	\$228	\$263	\$307	\$351	\$419	\$493	\$571	\$693	\$839	\$546	\$635

SWISH

To Order, Specify:

- ① Model number
- ② Laminate color
- ③ Fabric selection: vendor, pattern, color

② Laminate Color Options:

ALB Alabaster	GRH Graphite
AUT Autumn	HGL High Line
BLO Blonde Echo	SHD Shadow
BBN Bourbon	SHE Shea
BZW Brazilwood	SLG Slate Grey
BBL Bridal Blanco	STU Studio Teak
BRG Brighton	TAU Taupe
DWH Designer White	VIN Vintage
DOV Dove Grey	WLH Walnut Heights

Order Check List



page 196

Product Specifications

page 40

POWER AND DATA

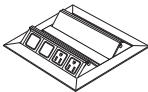

NOTE: Refer to Specification and Planning Guide page 10 for detailed information regarding placement of EC10 and EC11 units.

Description	① Model	D	W	CTN WT	CU FT	Net Price
 <p>Mini Grommet Power and Data Tilt Up</p>	<p>EC10</p> <ul style="list-style-type: none"> · not available on collaborative tables · fluid one touch tilt up access · one power receptacle - 120 volt; 15 amp with one voice/data port adapter to accept most jack manufacturers · 72" power cord with molded plug · drop in field installation required · cutout provided in top at specified location · UL listed component · silver finish 	4 1/4	5 1/2	6	1	\$335
 <p>Mini Power Tilt Up</p>	<p>EC11</p> <ul style="list-style-type: none"> · not available on collaborative tables · fluid one touch tilt up access · two power receptacles - 120 volt; 15 amp · 72" power cord with molded plug · drop in field installation required · cutout provided in top at specified location · UL listed component · silver finish 	4 1/4	5 1/2	6	1	\$349
 <p>Mini Power and USB Tilt Up</p>	<p>EC12</p> <ul style="list-style-type: none"> · not available on collaborative tables · fluid one touch tilt up access · one power receptacle - 120 volt; 15 amp dual powered USB · 72" power cord · drop in field installation required · cutout provided in top at specified location · UL listed component · silver finish 	4 1/4	5 1/2	6	1	\$436
 <p>Dual Power and Data Tilt Up</p>	<p>EC13</p> <ul style="list-style-type: none"> · available on collaborative tables only EG030 center location · fluid one touch tilt up access · back to back tilt sections · two power receptacles - 120 volt; 15 amp with two voice/data port adapters to accept most jack manufacturers in each section · two 72" power cords with molded plug · drop in field installation required · cutout provided in center top · UL listed component · silver finish 	8	8 3/8	16	1	\$889

POWER AND DATA

UNDERSURFACE ELECTRICAL

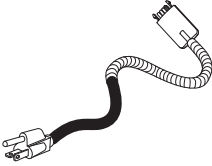
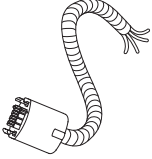
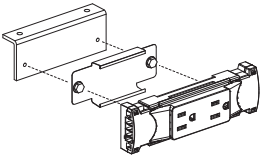
NOTE: Refer to Specification and Planning Guide pages 26 and 27 for detailed information regarding undersurface electrical.

	Description	① Model	L	CTN WT	CU FT	List Price
	Three Prong Power Infeed-Flex Metallic Conduit · single circuit infeed · two foot rubber cord transitions to metal conduit	SS48APE	48	2	1	\$176
		SS60APE	60	3	1	\$179
		SS72APE	72	3	1	\$216
		SS84APE	84	3	1	\$271
		SS96APE	96	3	1	\$281
		SS108APE	108	4	1	\$290
		SS120APE	120	4	1	\$298
	Hardwire Power Infeed-Flex Metallic Conduit · single or double circuit infeed · 4 wire 2 circuit system · 13 duplexes available per each circuit · when an EC10 or EC11 unit is plugged into an undersurface electrical duplex, the EC unit counts as one duplex in the total quantity of available duplexes per circuit	SS72HPE	72	3	1	\$109
		SS84HPE	84	3	1	\$119
		SS96HPE	96	3	1	\$128
		SS108HPE	108	4	1	\$137
		SS120HPE	120	4	1	\$146
		SS132HPE	132	4	1	\$157
		SS144HPE	144	4	1	\$165
		SS156HPE	156	5	1	\$174
		SS168HPE	168	5	1	\$184
		SS180HPE	180	5	1	\$194
		SS192HPE	192	5	1	\$203
		SS204HPE	204	6	1	\$212
		SS216HPE	216	6	1	\$223
		SS228HPE	228	6	1	\$233
		SS240HPE	240	6	2	\$240
		SS252HPE	252	7	2	\$248
SS264HPE	264	7	2	\$257		
SS276HPE	276	7	2	\$267		
SS288HPE	288	7	2	\$279		
SS300HPE	300	8	2	\$286		
	Duplex Receptacle Kit Circuit 1 · used in single circuit and multi-circuit applications · vertical and horizontal mounting brackets included	SSDUP1K		1	1	\$63
		Duplex Receptacle Kit Circuit 2 · used in multi-circuit applications · vertical and horizontal mounting brackets included	SSDUP2K		1	1
	Receptacle to Receptacle Connector	SSR2R		1	1	\$15
	H Block Connector Kit · accepts one power infeed and connects up to three jumpers · mounting bracket included	SSHCONNK		1	1	\$26

POWER AND DATA



To Order, Specify:

① Model number

Product Specifications
page 40









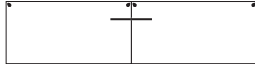

UNDERSURFACE ELECTRICAL

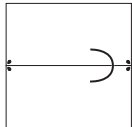
NOTE: Refer to Specification and Planning Guide pages 26 and 27 for detailed information regarding undersurface electrical.

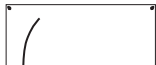
Description	① Model	L	CTN WT	CU FT	List Price
 Jumper	SSJK18	18	2	1	\$65
 Jumper	SSJK24	24	2	1	\$69
 Jumper	SSJK30	30	2	1	\$74
	SSJK36	36	2	1	\$79
	SSJK42	42	2	1	\$83
	SSJK48	48	2	1	\$92
	SSJK54	54	3	1	\$96
	SSJK60	60	3	1	\$101
	SSJK66	66	3	1	\$105
	SSJK72	72	3	1	\$112
	SSJK78	78	3	1	\$117
	SSJK84	84	3	1	\$122
	SSJK90	90	3	1	\$126
	SSJK96	96	3	1	\$132
	SSJK102	102	4	1	\$136
	SSJK108	108	4	1	\$140
	SSJK114	114	4	1	\$146
	SSJK120	120	4	1	\$153
	SSJK126	126	4	1	\$158
	SSJK132	132	4	1	\$162
	SSJK138	138	4	1	\$166
	SSJK144	144	4	1	\$172
	SSJK150	150	5	1	\$176
	SSJK156	156	5	1	\$182
	SSJK162	162	5	1	\$186
	SSJK168	168	5	1	\$193
	SSJK174	174	5	1	\$197
	SSJK180	180	5	1	\$202
	SSJK186	186	5	1	\$207
	SSJK192	192	5	1	\$212
	SSJK198	198	6	1	\$217
	SSJK204	204	6	1	\$223
	SSJK210	210	6	1	\$228
	SSJK216	216	6	1	\$233
	SSJK222	222	6	1	\$237
	SSJK228	228	6	1	\$242
	SSJK234	234	6	1	\$246
	SSJK240	240	6	2	\$251
	SSJK246	246	7	2	\$257
	SSJK252	252	7	2	\$263
	SSJK258	258	7	2	\$268
	SSJK264	264	7	2	\$272
	SSJK270	270	7	2	\$278
	SSJK276	276	7	2	\$282
	SSJK282	282	7	2	\$287
	SSJK288	288	7	2	\$293
	SSJK294	294	8	2	\$298
	SSJK300	300	8	2	\$305

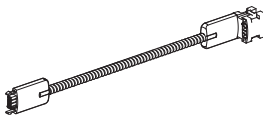
POWER AND DATA

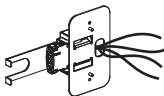
UNDERSURFACE ELECTRICAL

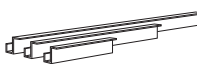
	Description	① Model	L	CTN WT	CU FT	List Price		
 	End to End Jumper · used with worksurfaces facing the same direction · used with 18" and 24" deep worksurfaces facing the opposite direction	SSJK24	24	2	1	\$69		
	End to End Jumper · used with 30" and 36" deep worksurfaces facing the opposite direction	SSJK28	28	2	1	\$72		
 	Back to Back Jumper · used with worksurfaces that do not have inset grommets	SSJK28	28	2	1	\$72		
	Back to Back Jumper · used with worksurfaces that have grommets inset 6"	SSJK40	40	2	1	\$82		
  	Bridge and Return Jumper · used with 18" deep worksurface	SSJK31	31	2	1	\$75		
	Bridge and Return Jumper · used with 24" deep worksurface	SSJK42	42	2	1	\$83		
	Bridge and Return Jumper · used with 30" deep worksurface	SSJK45	45	2	1	\$86		
	Bridge and Return Jumper · used with 36" deep worksurface	SSJK50	50	3	1	\$93		
	Vertical Jumper · 1 H block connector included · used when connecting power infeed or jumper in bench height units to H block connector on executive height worksurface	SSVJ24	24	2	1	\$99		
		SSVJ45	45	2	1	\$119		
	Conduit Clamp · includes screw	SSCCLMP		1	1	\$7		
	Description	① Model	D	W	H	CTN WT	CU FT	List Price
	Quick Disconnect · hard wire connection (4 wire), mounts to wall · accommodates single or multi-circuit · connects directly to jumper in place of power infeed	SSQD	1	2 3/4	4 5/8	1	1	\$92
	Round Grommet · fits 2 3/8" hole (60 mm) · overall diameter 2 3/4" · inside diameter 2" · field installed	SSGROM60				1	1	\$34
	Wire Management Trough · available in 12", 24" and 36" increments · field installed with screws provided	12WCT	2 1/2	12	2 1/2	2	1	\$79
		24WCT	2 1/2	24	2 1/2	3	1	\$93
		36WCT	2 1/2	36	2 1/2	3	1	\$102

POWER AND DATA

To Order, Specify:
 ① Model number

Product Specifications
 page 40

ArcCom Fabric Grading

For memo samples call ArcCom at 800-223-5466.

Grades and availability of fabric are subject to change without notice. Changes could include but are not limited to price increases, discontinued patterns, discontinued colors, etc. See jsifurniture.com for updated information.

Pattern	Grade	Pattern	Grade	Pattern	Grade
Allegra	E	Intaglio	E	Roundabout	E
Alpha	E	Intaglio 2	E	Royal Garden	H
Analog	H	Intersect	E	Sagrada	J
Antigua	E	Isabella	D	Sahara	E
Apex	G	Itajime	F	Samba	F
Arashi	F	Jardin	H	Santa Fe	E
Astral	F	Jing	E	Savannah	F
Axis	F	Jive	F	Sequoia	E
Bauble	F	Juliet	I	Shibori	G
Beat Box	G	Katano	E	Shimmer	D
Block Party	G	Key	F	Shimmer 2	D
Bloom	G	Kinetic	F	Silverado	D
Blossom	G	Kirigami	F	Spectrum	D
Boardwalk	E	Kumo	F	Spin	F
Bounce	G	Laurel	G	Spirit	D
Bourbon Street	F	Leaflet	F	Spot-On	F
Bronco	E	Legacy	E	Spotlight	G
Bubbly	G	Leonardo	G	Spring	G
Campus Stripe	F	Lotus	F	Spyro	F
Candy Land	G	Luxe	E	Stonehenge	G
Carnival	E	Lyre	E	Strand-It	G
Casablanca	G	Lyric	G	Strata	D
Cascade	F	Marathon	E	Symphony	G
Cassio	E	Mason	F	Tally	E
Channel	E	Masquerade	G	Tango	F
Chit-Chat	E	Meadow	G	Tectonic	F
Chroma	E	Meridian	C	Tempo	F
Cirque	G	Mesa	D	Terrain	D
Clarion	F	Metro	I	The Plaid	I
Coastline	E	Mirror, Mirror	E	Theory	C
Column	E	Monte Carlo	F	Trio	F
Compass	I	Moon Beam	E	Uptown	H
Constantine	H	Moon Beam 2	E	Urban	G
Crossroads	E	Morocco	F	Vineyard	F
Dakota	D	Murano	G	Vista	D
Dakota 2	D	Mystique	E	Volley	F
Dazzle	G	Navigator	F	Volt	J
Delphi	D	Network	G	Wonderland	G
Delta	D	Niagara	F	Yoyo	H
Durango	C	Nova	G	Zipline	F
Dynasty	E	Oasis	F		
Echo	G	Odyssey	E		
Eclipse	F	Omega	E		
Etc.	F	Pala	F		
Etch	E	Palatine	E		
Facet	J	Palatine 2	E		
Fiore	G	Panache	E		
Fireflies	E	Pebble Beach	D		
Forsythia	G	Pinball	E		
Francesca Wool	F	Pinpoint	E		
Francesca Wool II	H	Plateau	D		
Frontier	C	Polished	E		
Galaxy	E	Polo	F		
Gamma	E	Posh	F		
Gardenia	F	Prism	C		
Gatsby	D	Quad	F		
Gem	D	Radiant	G		
Glimmer	E	Radius	G		
Grand Central	E	Ravenna	F		
Grid	F	Rhythm	F		
Harlequin	G	Ringling	F		
Hopscotch	G	Riviera	G		
Iguana	E	Robotic	F		
Illusion	C	Rodeo	D		

Maharam Fabric Grading

For memo samples call Maharam at 800-645-3943.

Grades and availability of fabric are subject to change without notice. Changes could include but are not limited to price increases, discontinued patterns, discontinued colors, etc. See www.jsifurniture.com for updated information.

Pattern	Grade	Pattern	Grade	Pattern	Grade	Pattern	Grade	Pattern	Grade
Abacus	J	Couple	H	Manner	C	Schema	F	Vineyard	I
Abacus Standard	G	Cover	F	Marquee	E	Scout	F	Voyage	I
Acre	F	Crew	H	Matrix by Kvadrat	H	Scribe	F	Waterborn by	
Across	G	Crosspatch	J	Meander	G	Scuba	E	Kvadrat	I
Akimbo	F	Crush	F	Mechanism	H	Seam	F	Waxen	D
Align	F	Cursive	J	Medium	C	Semblance	C	Wedge	J
Alloy	E	Cycle	F	Melange Tweed	I	Sequence	F	Weimar	H
Alpaca Herringbone	J	Dapper	E	Meridian	F	Shadowbox	G	Whirl	F
Alter	F	Dart	G	Messenger	C	Sheen	F	Wool Rib	I
Anagram	I	Dash	F	Metric	C	Shuttle	G	Wrap	J
Arabesque	I	Decode	G	Micro	E	Shuttle Standard	E		
Aria	I	Defer	E	Mikado	J	Signal	F		
Array	G	Design 9297	J	Milestone	C	Silk Canvas	I		
Article	D	Disc	C	Mimic	G	Skein	E		
Balustrade	I	Disc Crypton	F	Mineral	F	Small Dot Pattern	J		
Banister	H	Disperse	H	Minicheck by		Snap	J		
Bar	C	Ditto	G	Alexander Girad	I	Soft Tweed	I		
Bar Crypton	F	Divide	C	Minimal	F	Sort	I		
Basel by Kvadrat	F	Divide Crypton	F	Mister	H	Stack	E		
Before	F	Divina by Kvadrat	G	Mode	D	Star by Kvadrat	H		
Beside	F	Divina MD by		Mohair Supreme	J	Stature	F		
Bevel	E	Kvadrat	G	Monk's Wool	J	Steady	E		
Bitmap	J	Divina Melange by		Mortise	G	Steady Crypton	F		
Blip	H	Kvadrat	G	Oblique	C	Steelcut by Kvadrat	G		
Blumen	J	Division	E	Octave	J	Steelcut Trio by			
Bound	E	Double Triangles	I	Offset	G	Kvadrat	G		
Boundary	F	Ellipsis	F	Omen	F	Strand	G		
Bridge	E	Emblem	G	Optik	J	Stride	G		
Bright Angle	H	Emboss	F	Orakelblume	J	Stripes	J		
Bright Cube	H	Enmesh	F	Ottoman Stripe	J	Strum	F		
Bright Grid	H	Exaggerated Plaid	J	Outback by Kvadrat	G	Sudden	F		
Candid	E	Exchange	E	Parched Silk	I	Surge	F		
Canvas by Kvadrat	F	Facets	I	Park	J	Tailor	F		
Cartouche	F	Fasten	H	Pavement	I	Tally	G		
Centric	I	Fathom	F	Paver	F	Tandem	G		
Certain	F	Feature	F	Pebble Wool	J	Teatro	H		
Chalet	F	Fiddle	H	Pebble Wool Multi	J	Technic	C		
Chance	G	Floret	G	Pennant	H	Terrace	F		
Checker by Alexander		Fluent Crypton	F	Pick	C	Ticker	G		
Girard	I	Fluted Silk	I	Pick Crypton	F	Tilt	G		
Checker Split	J	Focus	E	Pitch	E	Tokyo by Kvadrat	H		
Chenille Cord	G	Fraction	G	Plait	F	Tonica by Kvadrat	F		
Chenille Stripe	I	Fruit by Hella		Plait High		Tonus by Kvadrat	G		
Chime	E	Jongerius	J	Performance	G	Tonus Meadow by			
Chock	G	Garden	I	Plural	J	Kvadrat	G		
Cinch	D	Grade	H	Ply Mesh Black/Tan	J	Toostripe	J		
Cipher	H	Hallingdal by		Pocket	G	Trait	F		
Circles	J	Kvadrat	G	Point	J	Transport	I		
Circuit	G	Hedge	F	Quatrefoi	J	Tread	G		
Coach Cloth	I	Helix	H	Quick	E	Treat	G		
Cobblestone	J	Hero by Kvadrat	F	Radiant	J	Trellis	I		
Coda by Kvadrat	I	Houndstooth	I	Recollection	F	Tremor	F		
Coin	C	Hum	E	Reel	H	Trio	J		
Coin Crypton	F	Insignia	H	Regatta	J	Turn	H		
Coincide	E	Jacobs Coat	J	Remix by Kvadrat	F	Twice	F		
Coincide High		Kindred	H	Repeat Dot Ring	J	Twine	F		
Performance	G	Knot	I	Ring	G	Unisol	J		
Colline by Kvadrat	F	Lariat	E	Rise	I	Urban	H		
Colorwheel	I	Latch	J	Rove	F	Vary	E		
Column	H	Ledger	E	Rubric	F	Vases by Hella			
Commentary	F	Lens	G	Rule	G	Jongerius	I		
Compound	F	Lift	G	Runner	G	Velvet Stripe	J		
Confetti	J	Lineage	F	Runner Standard	E	Venn	G		
Cotton Velvet	J	Link	G	Salon	H	Vestige	H		

Mayer Fabric Grading

For memo samples please call Mayer at 800-428-4415.

Grades and availability of fabric are subject to change without notice. Changes could include but are not limited to price increases, discontinued patterns, discontinued colors, etc. See www.jsifurniture.com for updated information.

Pattern	Grade	Pattern	Grade	Pattern	Grade	Pattern	Grade	Pattern	Grade
Acclaim	D	Destiny plus		Intrigue	D	Phoenix	C	Tangled Web	G
Align	C	Durablock™	E	Jekyll & Hyde	C	Pinehurst	D	Theory	C
All Seasons FR	C	Detail	E	Jenga	E	Pinnacle	D	Time Line	E
All Use FR	C	Disco	E	Jitterbug	E	Plaza	D	Toss Up	D
Amadeus	G	Dublin Tweed FR	D	Journey	E	Portal	E	Tributary	D
Antique	D	Durango	C	Jubilee	D	Positive Thoughts	G	Turnabout	G
Apex	C	Duraweave® 10	B	Juncture	H	Prado	D	Tussah	D
Arabesque	E	Echo	D	Karma	F	Primo	D	Twister	E
Aristocrat	D	Ecosphere	F	Katagami	J	Prism	C	Uptown	C
Array	F	Eleanor Rigby	F	Key Largo	C	Pulse	C	Valet	C
Artistry	C	Element	C	Kismet	F	Punch	C	Variant	C
Ascension	G	Empire	I	Kobe	C	Quark	F	Venetian	H
Athens FR	D	Emu	C	Komodo	D	Quattro	B	Venue	D
Atomic	C	Encore	F	Laredo	E	Rain Dance	E	Verona	C
Aurora	G	Enigma	G	Linen	C	Ranchero	A	Vibrant	D
Avenue	F	Entourage	F	Links	D	Rapport	C	Viewpoint	F
Awakening	H	Entwine	D	Locomotion	D	Ratio	F	Vintage Mohair	I
Banner	C	Equation	D	Longhorn	D	Razzmatazz	F	Vinyl Stat ESD	D
Bar None	E	Equinox	D	Lunar	E	Realm	F	Vogue	E
Batik	C	Erode	G	Madras	E	Rebound	F	Volante	H
BeBop	F	Escapade	G	Madrid SP Black	A	Reiki	F	Wallaby SP Black	A
Bella	F	Esprit	D	Makore	F	Relic	F	Webscape	D
Berkshire	D	Essex	D	Malibu	D	Replay	F	Whimsy	G
Big Top	F	Europa	E	Mandala	H	Reveal	D	Wildflower	G
Blocks	C	Evolve	G	Marquise	C	Reverb	C	Willow	E
Bolero	D	Facets	F	Marvel	F	Rhythm	G	Wool Boucle	G
Botanica	F	Factor	D	Matrix	G	Rift	D	Xanadu	G
Boteh	J	Fairy Tales	G	Maverick	C	Rock & Roll	F		
Brio	E	Fanfare	F	Maze	F	Round 'N Round	F		
Bungalow	I	Fantasy	F	Meander	D	Sakura	G		
Burst	E	Fathom	E	Melody	E	Samurai	F		
Camelot	E	Figure Eight	C	Metro	D	Sashiko	G		
Canvas	E	Finale	D	Microdot	C	Sequel	B		
Caressa FR	C	Finesse	C	Milano	D	Sequel plus			
Caressa Suede	C	Finish Line	E	Monogram	D	Durablock™	D		
Cascade	D	Flock	G	Moonscape	C	Sequence	C		
Catalyst	D	Florentino	C	Mosaic	D	Shantung	D		
Cavalier	C	Flower Power	D	Mosaic plus		Sherlock	C		
Cayman	F	Focal Point	C	Durablock™	F	Shibori	F		
Celtic	E	Forte	A	Motif	G	Shimmer	F		
Chaps FR	C	Foundation 10	B	Myriad	F	Sierra SP Black	A		
Charade	G	Gala	F	Mystic C		Silk Screen	C		
Charette	E	Geisha	G	New Dimensions	G	Silverweave	D		
Circuit	H	Genesis	C	Nirvana	G	Skate	D		
Circumference	G	Genesis plus		Nostalgia	D	Sketch	C		
Collage	G	Durablock™	D	Nuance	E	Slick	D		
Component	D	Glee	D	Nylon-Stat ESD	E	Smart Suede	D		
Contempo	C	Glimmer	E	Obi	F	Social Network	E		
Continuum	C	Groundworks	F	Obsession	G	Solaris	F		
Cork	E	Guardian	C	On The Spot	G	Soleil	F		
Counterpoint	D	Haberdash	C	Optic	C	Solid Ground	E		
Cross Check	B	Habitat	E	Orbit	D	Sophisticate	C		
Crystals	D	Hole In One	F	Origami	F	Source	D		
Cuddle Up	F	Holiday	E	Ottoman	F	Source plus			
Curlicue	C	Hombre	E	Outback	C	Durablock™	E		
Dakota	C	Hoopla	D	Oxen SP Black	A	Spacer Mesh	B		
Dande	E	Hopsack	E	Palermo	D	Spirograph	D		
Dapper	C	Illusion	G	Papache	G	Spotlight	F		
Daydream	D	Images	D	Paparazzi	F	Stanza	E		
Dazzle	D	Impulse	D	Pastime	E	Stop & Go	F		
Debonair	G	In The Groove	D	Patent	E	Stratosphere	H		
Debut	F	Infinity	G	Patio	C	Suede	D		
Destiny	D	Interlace	D	Pavilion	F	Swank	F		
		Interlochen	D	Peerless	C	Synapse	F		

FABRIC GRADING

Momentum Fabric Grading

For memo samples call Momentum at 800-366-6839.

Grades and availability of fabric are subject to change without notice. Changes could include but are not limited to price increases, discontinued patterns, discontinued colors, etc. See www.jsifurniture.com for updated information.

Pattern	Grade	Pattern	Grade	Pattern	Grade	Pattern	Grade	Pattern	Grade
Ace	C	Duo	F	Kudos	G	Row	D	Viva II	E
Acoustic	F	Ebb	F	Lana	I	Sail	H	Vox	B
Agora II	D	Edison	H	Ledge	E	Scan	I	Wander	F
Aldo	G	Effloresce	H	Lella	G	Scape	G	Waver	E
Align	I	Elevate	I	Lina	I	Scrabble	C	Waypoint	C
Allegory	I	Elle	F	Lineage	I	Scribe	D	Weaving Palettes	F
Amenity II	G	Emanate	H	Lineup	C	Sense	E	Whim	F
Amuse	D	Embark	F	Linq	I	Sidebar Crypton	F		
April	F	Eon	C	Livia	J	Sidebar Incase	F		
Ardour II	H	Essay	F	Lloyd	G	Sidestep	F		
Arrange	H	Estrella	H	Lore	F	Signet	I		
Ascend	E	Evolve	H	Loupe	I	Silica	F		
Audio	G	Expo	B	Lucio	H	Silica Andy	G		
Audubon	H	Feliz	G	Ludwig	G	Silica Breeze	G		
Avanti	H	Felt	G	Malmo	G	Silica Deflect	G		
Avenue	D	Felt Melange	G	Mapping Ideas	G	Silica Etch	F		
Axis	C	Flection	G	Marathon	B	Silica Fiona	G		
Bandwidth II	F	Fleet	E	Marcel	H	Silica Fritz	G		
Bangle	A	Flow	G	Medley	F	Silica Hiatus	G		
Banter	H	Flux	G	Mensa	H	Silica Hoop	G		
Basis	B	Focal	D	Method	G	Silica Leather	F		
Beeline	C	Foray	D	Millennium	B	Silica Reach	G		
Beep	E	Free	C	Mix	I	Silica Roam	G		
Bento	F	Fringe	E	Molto	H	Silica Stride	G		
Bias	G	Fuse	A	Nagoya	H	Silica Tech	F		
Bloc	G	Gentry	H	Neon	H	Silica Waltz	G		
Boom II	D	Geo	J	Nifty	D	Silk Struktur	H		
Boxcar	G	Golden Leaf Tree	E	Nile	H	Sketching Air	G		
Bravo II	D	Gradient 18	H	Nimble	H	Skip	C		
Brisk	G	Gradient 36	J	Oath	E	Small Talk	G		
Buoy	G	Gradient Solid	F	Odyssey	B	Solace	C		
Cairns	H	H2O	J	Ohs II	G	Solo 2	D		
Cairo II	G	Habit	C	Ona	I	Soma	G		
Camber	F	Hearsay	H	Origin	A	Sort	F		
Canter	C	Helm	F	Ozone	H	Span Crypton	E		
Carlo	H	Hickory Leaf	D	Pace Crypton	E	Span Incase	D		
Cashmere II	C	Hive	E	Pace Incase	D	Spin	G		
Catalogue	H	Hue	C	Panorama	J	Splendeur	J		
Central	E	Hula	H	Parable	F	Starboard	F		
Centric	F	Icon	D	Parkside Crypton	F	Streamers	D		
Channel	E	Idyll	G	Parkside Incase	E	Strut	E		
Chant	F	Illumina	I	Parterre	E	Sublime II	C		
Chipper	I	Impact	D	Passages	I	Substance	J		
Cinch	B	Imperial Mohair	J	Perk	B	Sway II	G		
Cite	G	Index	G	Photon	H	Symbol	I		
Clang	D	Infinity	B	Pierre	G	Synergy	D		
Classique	J	Infusion	F	Ping	D	Syntax	C		
Context	B	Inner Circle	H	Pique	D	System	G		
Core	B	Insight	A	Plus	F	Tactic	G		
Course	G	Interim	I	Propensity	C	Tesla	G		
Cover Cloth	C	Intermezzo	I	Prospect	D	Tetra	D		
Crete	H	Intermix II	D	Proviso	G	Tone	E		
Current	C	Intersect	C	Proximity	G	Torque	H		
Cycle	D	Interval	B	Quirk	D	Tradition	B		
Dash	F	Isla	E	Raffia	I	Trefoil	I		
Dayspell	H	Jardin	G	Rally	H	Trove	H		
Decode	C	Jest	F	Rattan	I	Turin	G		
Delano	G	Jitney	E	Recollection II	G	Twist	G		
Delve	I	Juncture	H	Redux	D	Upside	G		
Dive	F	Keynote	D	Rein II	D	Vario	D		
Dividend	G	Kindle	F	Respite	C	Veer	H		
Dogwood Leaves	E	Kindred	F	Revolve	H	Velocity	D		
Domain	F	Kinney	D	Riga	G	Venue	D		
Drift	G	Knack	C	Rivet	D	Via	C		

Stinson Fabric Grading

For memo samples call Stinson at 800-841-6279.

Grades and availability of fabric are subject to change without notice. Changes could include but are not limited to price increases, discontinued patterns, discontinued colors, etc. See www.jsifurniture.com for updated information.

Pattern	Grade	Pattern	Grade	Pattern	Grade	Pattern	Grade	Pattern	Grade
Abacus	G	Citadel	C	Gravity	E	New Hempstead	C	Squire	E
Acanthus	H	Clean Slate	D	Grille	D	Next Scene	F	Stat-Con	E
Ace	C	Coco	F	Grove	G	Nova	E	Stellar	D
Acrobat	G	Colden	F	Hands On	F	Now & Zen w/Agion	I	Sterling w/Agion	F
Adirondack	F	Colorguard	C	Happy Hour	E	Olympus	F	Stipple	D
Aero	F	Comeback	G	Happy Tappy	I	On The Money	F	Stitch In Time	D
Affinity	F	Concentric	G	Haven	E	Orbit	D	Straight and	
Alchemy	E	Connect	C	Helix	H	Oscillate	I	Narrow	G
Alfresco	G	Continuum	E	Hi-Fi	D	Outlander	D	Stratford	I
Algiers	G	Core	C	Hive	D	Oxford	C	Sumatran Palm	H
Alignment	G	Cottonwood	G	Horizons	H	Pacifica	G	Summit	E
All American	B	Courtyard	H	Hot Spot	F	Panorama	J	Sunburst	G
Aloha	H	Cozy	E	Hourglass	G	Park Avenue	F	Sundance	
Apex.Crypton Revl	E	Criss Cross	C	Hudson	G	Patriot Plus II	C	w/Stakleen	E
Arc	F	Cruisin	H	Hush	F	Perimeter	D	Sunswept	I
Archetype	E	Crypton Metro	D	I Spy	H	Persuasion	E	Supersillyness	I
Arioso	E	Crypton Suede	D	Impression	H	Petals	G	Swivel	G
Ascend	F	Crystalline	G	Inside Track	D	Polka	E	Symmetry	H
Aspen	F	Curves Ahead	G	Interplay	F	Portico	F	Symphony Classic	C
Atlas	C	Cyma	H	Interval	E	Posh	E	Tender	H
Atmosphere	C	Daddy-O w/Agion	G	Isabella	H	Prisma	F	Tendrill	D
Auberge	H	Dakota	D	Jala	I	Profile	E	Tessellate	G
Aura	I	Dart	C	Jam Session		Radiance	H	Tessuto	C
Avant	C	Dash	D	w/Agion	I	Raffia	E	Thicket	D
Balance Beam	G	Deflection	G	Jambi Stripe	G	Rainier	C	Tracing	E
Bali	F	Delphi	F	Jasmine Screen	F	Rally	B	Tranquility	H
Balustrade	H	Detail	G	Jump w/Agion	I	Raquette	G	Transcend	C
Bambu-Envi	F	Deza	I	Juxy	F	Realm	E	Trax	D
Banyan	F	Diffusion	I	Kambala	I	Respite	F	Tribeca	C
Bari	F	Diva	D	Ketana	H	Retrograde	D	True Path w/Agion	H
Bass Line	G	Dodgeball	G	Kilkenny Tweed	C	Revolution	G	Tuscan Hills	H
Beatbox	F	Double Time		Knock Knock	I	Revolve	H	Tweed	F
Beep Beep	G	w/Agion	I	Kusari	D	Rialto	C	Umbrian Rain	H
Bespoke	E	Duet	E	Labyrinth	G	Riddle	D	Up Tempo w/Agion	H
Bistro	C	Dynasty	C	Laredo	C	Rivera	F	Urban Grid	C
Blip	C	E'lan-HC	H	Latitude	D	Rogue II	B	Valise	D
Block Party	F	Effervescense	F	Lava	H	Rolling Stones	H	Vanish	H
Bon Voyage	J	Elderberry	G	Leaps & Bounds	F	Salinas	I	Vapor	F
Bongo	H	Eli	F	Lift	G	San Simeon	G	Varati	I
Breton	G	English Pub	C	Lindley Park	D	Satellite	D	Vegas	C
Brilliant	D	Entrada	G	Line Dance	F	Scintillate	E	Velocity	E
Bryant Park	C	Equinox	F	Links	G	Scout	C	Verdure - Envi	F
Budget Black	A	Excursion	E	Linus	F	Scribe	D	Vermont	H
Burkshire	C	Expressions	C	Liquid	E	Script	D	Vibe	F
Calla	G	Facet	D	Makeover	G	Seagrass	G	View	H
Camino	H	Fast Lane	D	Mali	G	Second Act	G	Vineyard	I
Cannon Beach	H	Fenestra	H	Malta	I	Sedona	H	Vintage	H
Canterbury	G	Figment	H	Manchester	E	Sentry - HC	C	Vision	C
Capreni	F	Finite	E	Marimba	F	Sequence	D	Voltage	H
Carlisle	D	Firefly	G	Martini	F	Shantung	C	Volterra-HC	H
Casablanca	I	Fizz	E	Matrix	E	Sideline	E	Vortexia	I
Cassidy	C	Flex	E	Mesa	H	Silverado w/Agion	F	Walk The Line	J
Catalina	F	Flight	G	Mica	D	Simplicity	C	Whirl	G
Catalyst	C	Flip Flops	G	Mingle	F	Skyline	G	Whisper	C
Catwalk	F	Florentine	G	Moccasin	C	Sleek	D	Whitney	F
Celeste	J	Folio	G	Modena	F	Smile	G	Willow Talk	H
Chakra	H	Freehand	E	Montage	E	Smoothie	C	Wink w/Agion	F
Channel	D	Furrows	D	Montana	C	Snuggle	E	Wish	I
Chauncey	D	Fuse	C	Moxie	F	Solitaire	D	Wyatt	D
Chi w/Agion	G	Geodesic	G	Mumbai	G	Spark	J	Ybor	F
Chloe	F	GeoMet	E	Natural World	J	Sphere	E	Ziggy	C
Chroma	E	Glacier	C	Naugaleather	C	Spindles	H	Zodiac	D
Cielo	H	Glisten	H	Naugasoft	C	Spirit Millennium	C	Zoom	E
Cinnamon Blossom	H	Gradation	E	Neochrome III	C	Splash	F		
Cirque	E	Grand Sierra	C	Nest	H	Sprint	C		

FABRIC GRADING

12WCT	217	SS0946AMR	171	SS1248ASF	174
24WCT	217	SS0946AR	168	SS1248ASR	172
36WCT	217	SS0948ASR	173	SS1248ASR-TK2	178
AC203CUP	169	SS0949AMR	171	SS1254ASF	174
AC403TRAY	169	SS0952AMR	171	SS1254ASR	172
AC408TRAY	169	SS0952AR	168	SS1254ASR-TK2	177
AC912PAP	169	SS0954ASR	173	SS1260ASF	174
EC10	214	SS0955AMR	171	SS1260ASR	172
EC11	214	SS0958AMR	171	SS1260ASR-TK2	177
EC12	214	SS0958AR	168	SS1266ASF	174
EC13	214	SS0960ASR	173	SS1266ASR	172
SS0630CU	150	SS0961AMR	171	SS1266ASR-TK2	177
SS0630TK	191	SS0964AMR	171	SS1272ASF	174
SS0636CU	150	SS0964AR	168	SS1272ASR	172
SS0636TK	191	SS0966ASR	173	SS1272ASR-TK2	177
SS0642CU	150	SS0967AMR	171	SS1278ASF	174
SS0642TK	191	SS0972ASR	173	SS1278ASR	172
SS0648CU	150	SS0978ASR	173	SS1278ASR-TK2	177
SS0648TK	191	SS0984ASR	173	SS1284ASF	174
SS0654CU	150	SS10LB	75, 131, 137, 148	SS1284ASR	172
SS0654TK	191	SS108APE	215	SS1284ASR-TK2	177
SS0660CU	150	SS108HPE	215	SS132HPE	215
SS0660TK	190	SS120APE	215	SS144HPE	215
SS0666CU	150	SS120HPE	215	SS1518-45BC	140
SS0666TK	190	SS1217DEB	183	SS1518-54BC	140
SS0672CU	150	SS1217TK	189	SS1518-60BC	140
SS0672TK	190	SS1218ASF	174	SS1518ASF	174
SS0678CU	150	SS1218ASR	172	SS1518ASF-TK2	180
SS0678TK	190	SS1218ASR-TK2	178	SS1518ASR	172
SS0684CU	150	SS1218DEB	182, 184	SS1518ASR-TK2	176
SS0684TK	190	SS1218TK	187, 189	SS15190T	159, 160
SS0916AR	168	SS1223DEB	183	SS1522AMR	170
SS0918ASR	173	SS1223TK	189	SS1524ASF	174
SS0922AMR	171	SS1224ASF	174	SS1524ASF-TK2	180
SS0922AR	168	SS1224ASR	172	SS1524ASR	172
SS0924ASR	173	SS1224ASR-TK2	178	SS1524ASR-TK2	176
SS0925AMR	171	SS1230ASF	174	SS1525AMR	170
SS0928AMR	171	SS1230ASR	172	SS15250T	159, 160
SS0928AR	168	SS1230ASR-TK2	178	SS1528AMR	170
SS0930ASR	173	SS1230DEB	182	SS15280T	159
SS0931AMR	171	SS1230TK	187	SS1530-45BC	140
SS0934AMR	171	SS1236ASF	174	SS1530-54BC	140
SS0934AR	168	SS1236ASR	172	SS1530-60BC	140
SS0936ASR	173	SS1236ASR-TK2	178	SS1530ASF	174
SS0937AMR	171	SS1236DEB	182	SS1530ASF-TK2	180
SS0940AMR	171	SS1236TK	187	SS1530ASR	172
SS0940AR	168	SS1242ASF	174	SS1530ASR-TK2	176
SS0942ASR	173	SS1242ASR	172	SS1530DEB	185
SS0943AMR	171	SS1242ASR-TK2	178	SS1530DESD	152

SS1530GHD	154	SS1542WHDL	161	SS1560ASR	172
SS1530HD	151	SS1542WHDR	161	SS1560ASR-TK2	175
SS153000	153	SS1542W00	162	SS1560DEB	185
SS1530SD	152	SS1542WSD	161	SS1560DESD	152
SS1530TK	193	SS1543AMR	170	SS1560GHD	153
SS1530WDESD	162	SS1546AMR	170	SS1560HD	151
SS1530WGHD	163	SS1548ASF	174	SS156000	153
SS1530WHD	161	SS1548ASF-TK2	180	SS1560SD	152
SS1530W00	162	SS1548ASR	172	SS1560TK	192
SS1530WSD	161	SS1548ASR-TK2	176	SS1560WDESD	162
SS1531AMR	170	SS1548DEB	185	SS1560WGHD	162
SS1534AMR	170	SS1548DESD	152	SS1560WHD	161
SS1536-45BC	140	SS1548GHDL	154	SS1560W00	162
SS1536-54BC	140	SS1548GHDR	154	SS1560WSD	161
SS1536-60BC	140	SS1548HDL	151	SS1561AMR	170
SS1536ASF	174	SS1548HDR	151	SS1564AMR	170
SS1536ASF-TK2	180	SS154800	153	SS1566ASF	174
SS1536ASR	172	SS1548SD	152	SS1566ASF-TK2	179
SS1536ASR-TK2	176	SS1548TK	193	SS1566ASR	172
SS1536DEB	185	SS1548WDESD	162	SS1566ASR-TK2	175
SS1536DESD	152	SS1548WGHDL	163	SS1566DEB	185
SS1536GHD	154	SS1548WGHDR	163	SS1566DESD	152
SS1536HD	151	SS1548WHDL	161	SS1566GHD	153
SS153600	153	SS1548WHDR	161	SS1566HD	151
SS1536SD	152	SS1548W00	162	SS156600	153
SS1536TK	193	SS1548WSD	161	SS1566SD	152
SS1536WDESD	162	SS1549AMR	170	SS1566TK	192
SS1536WGHD	163	SS1552AMR	170	SS1566WDESD	162
SS1536WHD	161	SS1554ASF	174	SS1566WGHD	162
SS1536W00	162	SS1554ASF-TK2	179	SS1566WHD	161
SS1536WSD	161	SS1554ASR	172	SS1566W00	162
SS1537AMR	170	SS1554ASR-TK2	175	SS1566WSD	161
SS1540AMR	170	SS1554DEB	185	SS1567AMR	170
SS1542ASF	174	SS1554DESD	152	SS1572ASF	174
SS1542ASF-TK2	180	SS1554GHD	153	SS1572ASF-TK2	179
SS1542ASR	172	SS1554HD	151	SS1572ASR	172
SS1542ASR-TK2	176	SS155400	153	SS1572ASR-TK2	175
SS1542DEB	185	SS1554SD	152	SS1572DEB	185
SS1542DESD	152	SS1554TK	193	SS1572DESD	152
SS1542GHDL	154	SS1554WDESD	162	SS1572GHD	153
SS1542GHDR	154	SS1554WGHD	162	SS1572HD	151
SS1542HDL	151	SS1554WHD	161	SS157200	153
SS1542HDR	151	SS1554W00	162	SS1572SD	152
SS154200	153	SS1554WSD	161	SS1572TK	192
SS1542SD	152	SS1555AMR	170	SS1572WDESD	162
SS1542TK	193	SS1558AMR	170	SS1572WGHD	162
SS1542WDESD	162	SS156HPE	215	SS1572WHD	161
SS1542WGHDL	163	SS1560ASF	174	SS1572W00	162
SS1542WGHDR	163	SS1560ASF-TK2	179	SS1572WSD	161

SS1578ASF	174	SS1818-54BBFTR	141	SS1830-60BBFWL	146
SS1578ASF-TK2	179	SS1818-54FFTL	142	SS1830-60BBFWR	146
SS1578ASR	172	SS1818-54FFTR	142	SS1830-60FFWL	146
SS1578ASR-TK2	175	SS1818-54HL	148	SS1830-60FFWR	146
SS1578DEB	185	SS1818-54HR	148	SS1830-60HD	147
SS1578DESD	152	SS1818-60BBFSSTL	145	SS1830BBF	68
SS1578GHD	153	SS1818-60BBFSSTR	145	SS1830CUSH	213
SS1578HD	151	SS1818-60BBFTL	141	SS1830HD	69
SS157800	153	SS1818-60BBFTR	141	SS1830MBBF	130
SS1578SD	152	SS1818-60FFTL	142	SS1830MHD	131
SS1578TK	192	SS1818-60FFTR	142	SS1830MLF	130
SS1584ASF	174	SS1818-60HL	148	SS1830MOS	131
SS1584ASF-TK2	179	SS1818-60HR	148	SS1830MRO	128
SS1584ASR	172	SS1818CUSH	213	SS1830MSD	131
SS1584ASR-TK2	175	SS1818DEB	184	SS1836-45BBFT	143
SS1584DEB	185	SS1818MBBF	126, 201	SS1836-45HD	147
SS1584DESD	152	SS1818MFF	126, 201	SS1836-54BBFT	143
SS1584GHD	153	SS1818MHL	131	SS1836-54HD	147
SS1584HD	151	SS1818MHR	131	SS1836-60BBFT	143
SS158400	153	SS1818MKLC	130	SS1836-60HD	147
SS1584SD	152	SS1818MKRC	130	SS1836BBF	68
SS1584TK	192	SS1818MLHDC	129	SS1836CUSH	213
SS168HPE	215	SS1818MLOC	128	SS1836HD	69
SS180HPE	215	SS1818MOS	131	SS1836MBBF	130
SS1809MLHD	126	SS1818MRHDC	129	SS1836MHD	131
SS1809MLHDC	129	SS1818MRO	128	SS1836MLF	130
SS1809MLOC	128	SS1818MROC	128	SS1836MLFEL	127
SS1809MLOS	126	SS1818TK	189	SS1836MLFER	127
SS1809MRHD	126	SS1824CUSH	213	SS1836MMFEL	127
SS1809MRHDC	129	SS1824MKLC	130	SS1836MMFER	127
SS1809MROC	128	SS1824MKRC	130	SS1836MMFL	130
SS1809MROS	126	SS1824MLHDC	129	SS1836MMFR	130
SS1818-38FFF	201	SS1824MLOC	128	SS1836MOS	131
SS1818-38HL	201	SS1824MRHDC	129	SS1836MRO	128
SS1818-38HLFF	201	SS1824MRO	128	SS1836MSD	131
SS1818-38HR	201	SS1824MROC	128	SS1836MSDEL	127
SS1818-38HRFF	201	SS1830-45BBFT	144	SS1836MSDER	127
SS1818-38OS	201	SS1830-45BBFWL	146	SS1842ELR	73
SS1818-45BBFSSTL	145	SS1830-45BBFWR	146	SS1842ERR	73
SS1818-45BBFSSTR	145	SS1830-45FFWL	146	SS1848ELR	73
SS1818-45BBFTL	141	SS1830-45FFWR	146	SS1848ERR	73
SS1818-45BBFTR	141	SS1830-45HD	147	SS1860LC	74
SS1818-45FFTL	142	SS1830-54BBFT	144	SS1860LLC	75
SS1818-45FFTR	142	SS1830-54BBFWL	146	SS1860LRC	75
SS1818-45HL	148	SS1830-54BBFWR	146	SS1860RC	74
SS1818-45HR	148	SS1830-54FFWL	146	SS1866KC	67
SS1818-54BBFSSTL	145	SS1830-54FFWR	146	SS1866LC	74
SS1818-54BBFSSTR	145	SS1830-54HD	147	SS1866LLC	75
SS1818-54BBFTL	141	SS1830-60BBFT	144	SS1866LRC	75

SS1866RC	74	SS2142SD	155	SS2160WSD	164
SS1866SCHD	66	SS2142TK	195	SS2166DEB	185
SS1872KC	67	SS2142WDESD	164	SS2166DESD	155
SS1872LC	74	SS2142WGHD	165	SS2166GHD	156
SS1872LLC	75	SS2142WGHDR	165	SS2166HD	154
SS1872LRC	75	SS2142WHDL	163	SS216600	156
SS1872RC	74	SS2142WHDR	163	SS2166SD	155
SS1872SCHD	65	SS2142W00	164	SS2166TK	194
SS192HPE	215	SS2142WSD	164	SS2166WDESD	164
SS20LB	75, 131, 137, 148	SS2148DEB	185	SS2166WGHD	165
SS2018MP	68, 212	SS2148DESD	155	SS2166WHD	163
SS204HPE	215	SS2148GHDL	157	SS2166W00	164
SS2117DEB	183	SS2148GHDR	157	SS2166WSD	164
SS2117TK	188	SS2148HDL	154	SS2172DEB	185
SS2118DEB	181, 184	SS2148HDR	154	SS2172DESD	155
SS2118TK	186, 189	SS214800	156	SS2172GHD	156
SS2123DEB	183	SS2148SD	155	SS2172HD	154
SS2123TK	188	SS2148TK	195	SS217200	156
SS2130DEB	181, 185	SS2148WDESD	164	SS2172SD	155
SS2130DESD	155	SS2148WGHD	165	SS2172TK	194
SS2130GHD	157	SS2148WGHDR	165	SS2172WDESD	164
SS2130HD	154	SS2148WHDL	163	SS2172WGHD	165
SS213000	156	SS2148WHDR	163	SS2172WHD	163
SS2130SD	155	SS2148W00	164	SS2172W00	164
SS2130TK	186, 195	SS2148WSD	164	SS2172WSD	164
SS2130WDESD	164	SS2154DEB	185	SS2178DEB	185
SS2130WGHD	165	SS2154DESD	155	SS2178DESD	155
SS2130WHD	163	SS2154GHD	156	SS2178GHD	156
SS2130W00	164	SS2154HD	154	SS2178HD	154
SS2130WSD	164	SS215400	156	SS217800	156
SS2136DEB	181, 185	SS2154SD	155	SS2178SD	155
SS2136DESD	155	SS2154TK	195	SS2178TK	194
SS2136GHD	157	SS2154WDESD	164	SS2184DEB	185
SS2136HD	154	SS2154WGHD	165	SS2184DESD	155
SS213600	156	SS2154WHD	163	SS2184GHD	156
SS2136SD	155	SS2154W00	164	SS2184HD	154
SS2136TK	186, 195	SS2154WSD	164	SS218400	156
SS2136WDESD	164	SS216HPE	215	SS2184SD	155
SS2136WGHD	165	SS2160DEB	185	SS2184TK	194
SS2136WHD	163	SS2160DESD	155	SS228HPE	215
SS2136W00	164	SS2160GHD	156	SS240HPE	215
SS2136WSD	164	SS2160HD	154	SS2409MLHD	126
SS2142DEB	185	SS216000	156	SS2409MLHDC	129
SS2142DESD	155	SS2160SD	155	SS2409MLOC	128
SS2142GHDL	157	SS2160TK	194	SS2409MLOS	126
SS2142GHDR	157	SS2160WDESD	164	SS2409MRHD	126
SS2142HDL	154	SS2160WGHD	165	SS2409MRHDC	129
SS2142HDR	154	SS2160WHD	163	SS2409MROC	128
SS214200	156	SS2160W00	164	SS2409MROS	126

SS2418-45BBFSSTL	145
SS2418-45BBFSSTR	145
SS2418-45BBFTL	141
SS2418-45BBFTR	141
SS2418-45FFTL	142
SS2418-45FFTR	142
SS2418-45HL	148
SS2418-45HR	148
SS2418-54BBFSSTL	145
SS2418-54BBFSSTR	145
SS2418-54BBFTL	141
SS2418-54BBFTR	141
SS2418-54FFTL	142
SS2418-54FFTR	142
SS2418-54HL	148
SS2418-54HR	148
SS2418-60BBFSSTL	145
SS2418-60BBFSSTR	145
SS2418-60BBFTL	141
SS2418-60BBFTR	141
SS2418-60FFTL	142
SS2418-60FFTR	142
SS2418-60HL	148
SS2418-60HR	148
SS2418CUSH	212
SS2418MBBF	126
SS2418MFF	126
SS2418MHL	131
SS2418MHR	131
SS2418MKLC	130
SS2418MKRC	130
SS2418MLHDC	129
SS2418MLOC	128
SS2418MOS	131
SS2418MRHDC	129
SS2418MRO	128
SS2418MROC	128
SS2424CUSH	212
SS2424MKLC	130
SS2424MKRC	130
SS2424MLHDC	129
SS2424MLOC	128
SS2424MRHDC	129
SS2424MRO	128
SS2424MROC	128
SS2424T-17	209
SS2424UBB	210
SS2424UBBOS	211
SS2430-45BBFT	143

SS2430-45BBFWL	145
SS2430-45BBFWR	145
SS2430-45FFT	144
SS2430-45FFWL	146
SS2430-45FFWR	146
SS2430-45HD	147
SS2430-54BBFT	143
SS2430-54BBFWL	145
SS2430-54BBFWR	145
SS2430-54FFT	144
SS2430-54FFWL	146
SS2430-54FFWR	146
SS2430-54HD	147
SS2430-60BBFT	143
SS2430-60BBFWL	145
SS2430-60BBFWR	145
SS2430-60FFT	144
SS2430-60FFWL	146
SS2430-60FFWR	146
SS2430-60HD	147
SS2430BBF	68
SS2430CUSH	212
SS2430HD	69
SS2430LF	69
SS2430MBBF	130
SS2430MHD	131
SS2430MLF	130
SS2430MOS	131
SS2430MRO	128
SS2430MSD	131
SS2430UBB	210
SS2430UBBOS	211
SS2436-45BBFT	143
SS2436-45FFT	144
SS2436-45HD	147
SS2436-54BBFT	143
SS2436-54FFT	144
SS2436-54HD	147
SS2436-60BBFT	143
SS2436-60FFT	144
SS2436-60HD	147
SS2436BBF	68
SS2436CUSH	212
SS2436HD	69
SS2436LF	69
SS2436MBBF	130
SS2436MHD	131
SS2436MLF	130
SS2436MLFEL	127

SS2436MLFER	127
SS2436MMFEL	127
SS2436MMFER	127
SS2436MMFL	130
SS2436MMFR	130
SS2436MOS	131
SS2436MRO	128
SS2436MSD	131
SS2436MSDEL	127
SS2436MSDER	127
SS2436UBB	210
SS2436UBBOS	211
SS2442ELR	73
SS2442ERR	73
SS2448ELR	73
SS2448ERR	73
SS2448T-23	209
SS2448UBB	210
SS2448UBBOS	211
SS2460LFC	66
SS2460T-29	206
SS2466KC	67
SS2466LC	74
SS2466LLC	75
SS2466LRC	75
SS2466RC	74
SS2466SCHD	65
SS2466T-29	206
SS2472KC	67
SS2472LC	74
SS2472LFC	66
SS2472LLC	75
SS2472LRC	75
SS2472RC	74
SS2472SCHD	65
SS2472T-29	206
SS2478T-29	206
SS252HPE	215
SS264HPE	215
SS2717DEB	183
SS2717TK	188
SS2718DEB	181
SS2718TK	186
SS2723DEB	183
SS2723TK	188
SS2730DEB	181
SS2730TK	186
SS2736DEB	181
SS2736TK	186

SS276HPE	215	SS3072DD	64	SS3672RED	70
SS288HPE	215	SS3072LD	71	SS3672RFD	72
SS300HPE	215	SS3072LED	70	SS3672T-29	206
SS3009MLHDC	129	SS3072LFD	72	SS3678T-29	206
SS3009MLHD	126	SS3072RD	71	SS36ROUN-PN	208
SS3009MLOC	128	SS3072RED	70	SS36ROUN-PN-CAST	208
SS3009MLOS	126	SS3072RFD	72	SS36ROUN-RA	208
SS3009MRHD	126	SS3072T-29	206	SS36ROUN-RA-CAST	208
SS3009MRHDC	129	SS3078T-29	206	SS36SQCL-PN	207
SS3009MROC	128	SS30ROUN-PN	208	SS36SQCL-PN-CAST	207
SS3009MROS	126	SS30ROUN-PN-CAST	208	SS36SQCL-RA	207
SS3018MBBF	126	SS30ROUN-RA	208	SS36SQCL-RA-CAST	207
SS3018MFF	126	SS30ROUN-RA-CAST	208	SS36TRI-23	209
SS3018MKLC	130	SS30SQCL-PN	207	SS4242T-23	209
SS3018MKRC	130	SS30SQCL-PN-CAST	207	SS4242T-29	206
SS3018MLHDC	129	SS30SQCL-RA	207	SS4260T-29	206
SS3018MLOC	128	SS30SQCL-RA-CAST	207	SS4266T-29	206
SS3018MRHDC	129	SS3609MLOC	128	SS4272T-29	206
SS3018MROC	128	SS3609MROC	128	SS4278T-29	206
SS3024MKLC	130	SS3618MBBF	126	SS4842CCBL-29	204
SS3024MKRC	130	SS3618MFF	126	SS4842CCBL-42	202
SS3024MLHDC	129	SS3618MKLC	130	SS4848CCBL-29	204
SS3024MLOC	128	SS3618MKRC	130	SS4848CCBL-42	202
SS3024MRHDC	129	SS3618MLOC	128	SS4848T-29	206
SS3024MROC	128	SS3618MROC	128	SS4854CCBL-29	204
SS3030T-17	209	SS3624MKLC	130	SS4854CCBL-42	202
SS3036MLFEL	127	SS3624MKRC	130	SS4860CCBL-29	204
SS3036MLFER	127	SS3624MLOC	128	SS4860CCBL-42	202
SS3036MMFEL	127	SS3624MROC	128	SS48APE	215
SS3036MMFER	127	SS3636T-17	209	SS48TRI-23	209
SS3042CCBL-29	205	SS3636T-29	206	SS60APE	215
SS3042CCBL-42	203	SS3642CCBL-29	204	SS72APE	215
SS3048CCBL-29	205	SS3642CCBL-42	202	SS72HPE	215
SS3048CCBL-42	203	SS3648CCBL-29	204	SS84APE	215
SS3054CCBL-29	205	SS3648CCBL-42	202	SS84HPE	215
SS3054CCBL-42	203	SS3654CCBL-29	204	SS96APE	215
SS3060CCBL-29	205	SS3654CCBL-42	202	SS96HPE	215
SS3060CCBL-42	203	SS3660CCBL-29	204	SSB18102MT	137
SS3060LD	71	SS3660CCBL-42	202	SSB18108MT	137
SS3060RD	71	SS3660T-29	206	SSB1818MBF	134
SS3060T-29	206	SS3666ED	64	SSB1818MHL	135
SS3066DD	64	SS3666LED	70	SSB1818MHR	135
SS3066LD	71	SS3666LFD	72	SSB1818MOS	135
SS3066LED	70	SS3666RED	70	SSB1818MT	137
SS3066LFD	72	SS3666RFD	72	SSB1824MBF	134
SS3066RD	71	SS3666T-29	206	SSB1824MHD	134
SS3066RED	70	SS3672ED	64	SSB1824MOS	135
SS3066RFD	72	SS3672LED	70	SSB1824MT	137
SS3066T-29	206	SS3672LFD	72	SSB1830MBF	134

SSB1830MHD	134	SSB2496MT	136	SSJK48	216
SSB1830MOS	135	SSCCLMP	217	SSJK50	217
SSB1830MSD	135	SSDUP1K	215	SSJK54	216
SSB1830MT	137	SSDUP2K	215	SSJK60	216
SSB1836MBF	134	SSGROM60	217	SSJK66	216
SSB1836MHD	134	SSHCONNK	215	SSJK72	216
SSB1836MOS	135	SSJK102	216	SSJK78	216
SSB1836MSD	135	SSJK108	216	SSJK84	216
SSB1836MT	137	SSJK114	216	SSJK90	216
SSB1842MT	137	SSJK120	216	SSJK96	216
SSB1848MT	137	SSJK126	216	SSK-BTD1-29	132, 138
SSB1854MT	137	SSJK132	216	SSK-BTD2-29	132, 138
SSB1860MT	137	SSJK138	216	SSK-LBRKT-18	132, 138
SSB1866MT	137	SSJK144	216	SSK-LBRKT-24	132, 138
SSB1872MT	137	SSJK150	216	SSK-LBRKT-30	132, 138
SSB1878MT	137	SSJK156	216	SSK-LBRKT-36	132, 138
SSB1884MT	137	SSJK162	216	SSK-LEG1-29	132, 138
SSB1890MT	137	SSJK168	216	SSK-LEG2-29	132, 138
SSB1896MT	137	SSJK174	216	SSK-OHS-A	158
SSB24102MT	136	SSJK18	216	SSK-OHS-B	158
SSB24108MT	136	SSJK180	216	SSK-OHS-C	158
SSB2418MBF	134	SSJK186	216	SSK-OHS-D	159, 160
SSB2418MHL	135	SSJK192	216	SSK-OHS-E	159, 160
SSB2418MHR	135	SSJK198	216	SSK-OHS-F	159
SSB2418MOS	135	SSJK204	216	SSK-TOPSPACER1	132, 138
SSB2418MT	136	SSJK210	216	SSK-TOPSPACER2	132, 138
SSB2424MBF	134	SSJK216	216	SSQD	217
SSB2424MHD	134	SSJK222	216	SSR2R	215
SSB2424MOS	135	SSJK228	216	SST1530TRAN	150
SSB2424MT	136	SSJK234	216	SST1536TRAN	150
SSB2430MBF	134	SSJK24	216, 217	SST1542TRAN	150
SSB2430MHD	134	SSJK240	216	SST1548TRAN	150
SSB2430MOS	135	SSJK246	216	SST1554TRAN	150
SSB2430MSD	135	SSJK252	216	SST1560TRAN	150
SSB2430MT	136	SSJK258	216	SST1566TRAN	150
SSB2436MBF	134	SSJK264	216	SST1572TRAN	150
SSB2436MHD	134	SSJK270	216	SST1578TRAN	150
SSB2436MOS	135	SSJK276	216	SST1584TRAN	150
SSB2436MSD	135	SSJK28	217	SST1818RECTG	91
SSB2436MT	136	SSJK282	216	SST1830RECTG	91
SSB2442MT	136	SSJK288	216	SST1836RECTG	91
SSB2448MT	136	SSJK294	216	SST1842RECTG	91
SSB2454MT	136	SSJK300	216	SST1848RECTG	91
SSB2460MT	136	SSJK30	216	SST1854RECTG	90
SSB2466MT	136	SSJK31	217	SST1860RECTG	90
SSB2472MT	136	SSJK36	216	SST1866RECTG	90
SSB2478MT	136	SSJK40	217	SST1872RECTG	90
SSB2484MT	136	SSJK42	216, 217	SST1878RECTG	90
SSB2490MT	136	SSJK45	217	SST1884RECTG	89

SST1890RECTG	89	SST3024RTRNG-L	121	SST3090RECTGO	79
SST1896RECTG	89	SST3024RTRNG-R	121	SST3096RECTG	85
SST2418RECTG	88	SST3054CCBP	200	SST3096RECTGO	79
SST2430RECTG	88	SST3060CCBP	200	SST3463YG-AA	116
SST2430RECTGO	82	SST3060RECTG	86	SST3618BRDGG	124
SST2436RECTG	88	SST3060RECTGO	80	SST3618RTRNG-L	122
SST2436RECTGO	82	SST3066AFING-BC	104	SST3618RTRNG-R	122
SST2442RECTG	88	SST3066AFING-CB	103	SST3624BRDGG	123
SST2442RECTGO	82	SST3066CCBP	200	SST3624RTRNG-L	121
SST2448RECTG	88	SST3066RECTG	86	SST3624RTRNG-R	121
SST2448RECTGO	82	SST3066RECTGO	80	SST3654CCBP	199
SST2454RECTG	88	SST3066UFING-BC	98	SST3660CCBP	199
SST2454RECTGO	82	SST3066UFING-CB	97	SST3660RECTG	84
SST2460RECTG	88	SST3066UFINGO-BC	94	SST3660RECTGO	78
SST2460RECTGO	82	SST3066UFINGO-CB	93	SST3666AFING-CD	102
SST2466AFING-AB	106	SST3072AFING-BC	104	SST3666AFING-DC	101
SST2466AFING-BA	105	SST3072AFING-CB	103	SST3666CCBP	199
SST2466RECTG	88	SST3072CCBP	200	SST3666RECTG	84
SST2466RECTGO	82	SST3072NKG-L	119	SST3666RECTGO	78
SST2466UFING-AB	100	SST3072NKG-R	119	SST3666UFING-CD	96
SST2466UFING-BA	99	SST3072RECTG	86	SST3666UFING-DC	95
SST2472AFING-AB	106	SST3072RECTGO	80	SST3666UFINGO-CD	92
SST2472AFING-BA	105	SST3072UFING-BC	98	SST3666UFINGO-DC	92
SST2472RECTG	87	SST3072UFING-CB	97	SST3672AFING-CD	102
SST2472RECTGO	81	SST3072UFINGO-BC	94	SST3672AFING-DC	101
SST2472UFING-AB	100	SST3072UFINGO-CB	93	SST3672CCBP	199
SST2472UFING-BA	99	SST3078AFING-BC	104	SST3672NKG-L	118
SST2478AFING-AB	106	SST3078AFING-CB	103	SST3672NKG-R	118
SST2478AFING-BA	105	SST3078NKG-L	119	SST3672NKG-L	117
SST2478RECTG	87	SST3078NKG-R	119	SST3672NKG-R	117
SST2478RECTGO	81	SST3078RECTG	86	SST3672RECTG	84
SST2478UFING-AB	100	SST3078RECTGO	80	SST3672RECTGO	78
SST2478UFING-BA	99	SST3078UFING-BC	98	SST3672UFING-CD	96
SST2484AFING-AB	106	SST3078UFING-CB	97	SST3672UFING-DC	95
SST2484AFING-BA	105	SST3078UFINGO-BC	94	SST3672UFINGO-CD	92
SST2484BMG-L	120	SST3078UFINGO-CB	93	SST3672UFINGO-DC	92
SST2484BMG-R	120	SST3084AFING-BC	104	SST3678AFING-CD	102
SST2484RECTG	87	SST3084AFING-CB	103	SST3678AFING-DC	101
SST2484RECTGO	81	SST3084BMG-L	120	SST3678NKG-L	118
SST2484UFING-AB	100	SST3084BMG-R	120	SST3678NKG-R	118
SST2484UFING-BA	99	SST3084NKG-L	119	SST3678NKG-L	117
SST2490RECTG	87	SST3084NKG-R	119	SST3678NKG-R	117
SST2490RECTGO	81	SST3084RECTG	85	SST3678RECTG	84
SST2496RECTG	87	SST3084RECTGO	79	SST3678RECTGO	78
SST2496RECTGO	81	SST3084UFING-BC	98	SST3678UFING-CD	96
SST3018BRDGG	124	SST3084UFING-CB	97	SST3678UFING-DC	95
SST3018RTRNG-L	122	SST3084UFINGO-BC	94	SST3678UFINGO-CD	92
SST3018RTRNG-R	122	SST3084UFINGO-CB	93	SST3678UFINGO-DC	92
SST3024BRDGG	123	SST3090RECTG	85	SST3684AFING-CD	102

SST3684AFING-DC	101
SST3684NKG-L	118
SST3684NKG-R	118
SST3684NKG0-L	117
SST3684NKG0-R	117
SST3684RECTG	83
SST3684RECTGO	77
SST3684UFING-CD	96
SST3684UFING-DC	95
SST3684UFING0-CD	92
SST3684UFING0-DC	92
SST3690RECTG	83
SST3690RECTGO	77
SST3696RECTG	83
SST3696RECTGO	77
SST3773YG-AA	116
SST3963YG-BB	116
SST4084YG-AA	116
SST4218BRDGG	73, 124
SST4218RTRNG-L	122
SST4218RTRNG-R	122
SST4224BRDGG	73, 123
SST4224RTRNG-L	121
SST4224RTRNG-R	121
SST4260CC	197
SST4266CC	197
SST4272CC	197
SST4273YG-BB	116
SST4278CC	197
SST4284CC	197
SST4584YG-BB	116
SST4818BRDGG	73, 124
SST4818RTRNG-L	122
SST4818RTRNG-R	122
SST4824BRDGG	73, 123
SST4824RTRNG-L	121
SST4824RTRNG-R	121
SST4854CCBP	198
SST4860CCBP	198

SST4860CRNRG-BB-L	115
SST4860CRNRG-BB-R	115
SST4860CRNRG-BC-R	115
SST4860CRNRG-CB-L	115
SST4866CCBP	198
SST4866CRNRG-BB-L	115
SST4866CRNRG-BB-R	115
SST4866CRNRG-BC-R	114
SST4866CRNRG-CB-L	114
SST4872CCBP	198
SST4872CRNRG-AB-R	114
SST4872CRNRG-BA-L	114
SST4872CRNRG-BB-L	114
SST4872CRNRG-BB-R	114
SST4872CRNRG-BC-R	114
SST4872CRNRG-CB-L	114
SST5418BRDGG	124
SST5418RTRNG-L	122
SST5418RTRNG-R	122
SST5424BRDGG	123
SST5424RTRNG-L	121
SST5424RTRNG-R	121
SST5460CRNRG-BB-L	113
SST5460CRNRG-BB-R	113
SST5460CRNRG-BC-R	113
SST5460CRNRG-CB-L	113
SST5466CRNRG-BB-L	113
SST5466CRNRG-BB-R	113
SST5466CRNRG-BC-R	112
SST5466CRNRG-CB-L	112
SST5472CRNRG-AB-R	112
SST5472CRNRG-BA-L	112
SST5472CRNRG-BB-L	112
SST5472CRNRG-BB-R	112
SST5472CRNRG-BC-R	112
SST5472CRNRG-CB-L	112
SST5478CRNRG-BB-L	111
SST5478CRNRG-BB-R	111
SST5478CRNRG-BC-R	111

SST5478CRNRG-CB-L	111
SST6018BRDGG	124
SST6018RTRNG-L	122
SST6018RTRNG-R	122
SST6024BRDGG	123
SST6024RTRNG-L	121
SST6024RTRNG-R	121
SST6060CRNRG-AB-R	111
SST6060CRNRG-AC-R	110
SST6060CRNRG-BA-L	111
SST6060CRNRG-BB-L	110
SST6060CRNRG-BB-R	110
SST6060CRNRG-BC-R	110
SST6060CRNRG-CA-L	110
SST6060CRNRG-CB-L	110
SST6066CRNRG-AB-R	110
SST6066CRNRG-AC-R	109
SST6066CRNRG-BA-L	110
SST6066CRNRG-BB-L	109
SST6066CRNRG-BB-R	109
SST6066CRNRG-BC-R	109
SST6066CRNRG-CA-L	109
SST6066CRNRG-CB-L	109
SST6072CRNRG-AB-R	108
SST6072CRNRG-AC-R	108
SST6072CRNRG-BA-L	108
SST6072CRNRG-BB-L	108
SST6072CRNRG-BB-R	108
SST6072CRNRG-BC-R	108
SST6072CRNRG-CA-L	108
SST6072CRNRG-CB-L	108
SST6078CRNRG-BB-L	107
SST6078CRNRG-BB-R	107
SST6078CRNRG-BC-R	107
SST6078CRNRG-CB-L	107
SSVJ24	217
SSVJ45	217

Bourne Price List



Intro Pages	
Seating Order Check List	2-3
Seating Product Information	4-5
Table Order Check List	6-7
Storage Order Check List	8-9
Table and Storage	
Product Information	10-13
Statement of Line/Overview	14-15
Typicals	16-17
Pricing Pages	
Seating	18-19
Standard Height Tables	20-23
Counter Height Tables	24-27
Bar Height Tables	28-29
Occasional Tables	30-31
Storage	32
Power	33
Index	34

Bourne Seating Order Check List:



Specify:

- 1. Model Number
- 2. Wood Species - Maple (M) or Walnut (W) upcharge applies when Walnut is specified
- 3. Wood Finish
- 4. Fabric Selection - vendor, pattern and color
- 5. Metal Foot Rail Color - Arctic Silver (ASL), Matte Black (MBK), Pewter (PEW) or Soft Nickel (SNK)
- 6. Optional Rubber Cushion Nylon Glides - no upcharge

Example:

BU7511D | **M** | **AUB** | **MOMENTUM** | **VOX** | **MYSTIC**
 (model #) | (wood species) | (finish) | (fabric vendor) | (pattern name) | (pattern color)

1. Model Number

2. Wood Species - Maple (M) or Walnut (W); upcharge applies

3. Wood Finish Options:

Maple Frame

ALE Ale	CGR Graphite Coordinate
AUB Auburn	CHL High Line Coordinate
AUT Autumn	CKC Khaki Coordinate
BRL Barley	LGC Legacy
CBE Blonde Echo Coordinate	MCH Mocha
BBN Bourbon	NTO Night Owl
CBZ Brazilwood Coordinate	PRL Praline
BRG Brighton	SAF Saffron
BUT Butterscotch	SIE Sienna
CIN Cinnamon	CST Studio Teak Coordinate
CLA Classic	TOF Toffee
CCF Coffee Coordinate	TRF Truffle
CCR Cremello Coordinate	VEN Venetian
EAR Earthy	CVI Vintage Coordinate
ESP Espresso	CWH Walnut Heights Coordinate
FLX Flax	

Walnut Frame (optional, upcharge applies)

AUB Auburn	SIE Sienna
ESP Espresso	TOF Toffee
MCH Mocha	TRF Truffle
NTO Night Owl	

4. Fabric Selection - Please supply the following:
 Fabric vendor Pattern name Pattern color

When specifying dual upholstery, indicate clearly which upholstery is to be applied to the seat/lower back and the upper back.

- Indicate direction of fabric - Railroaded or Up the Roll
- Please provide illustration, if available

All COM orders must include the following:

- Vendor's name, pattern name and color
- Sample of the fabric attached to the order
- Model numbers of items for fabric application
- Special application instructions (e.g., all stripes will be applied front to back unless specified otherwise)
- Customer and purchase order number

Ship prepaid COM material to:
 JSI
 Attn: COM Dept
 932 Mill Street
 Jasper, IN 47546

Application of fabric:

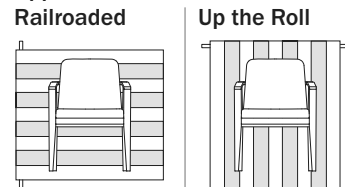

All COM orders will ship at standard lead time from receipt of COM except for orders requiring special custom matched finishes.

5. Metal Foot Rail Color - specify color:

ASL Arctic Silver	PEW Pewter
MBK Matte Black	SNK Soft Nickel

6. Optional Rubber Cushion Nylon Glides - no upcharge

Seating Order Check List

Single Textile Seating

a. frame species

(choose one)

- maple
- walnut (*upcharge applies*)

finish color:

(see previous page for finish choices) _____

b. fabric selection

- vendor
- pattern
- color

(see pages 12-20 in JSI Seating price list for fabric choices) _____

c. metal color (if applicable)

(choose one)

- arctic silver
- matte black
- pewter
- soft nickel

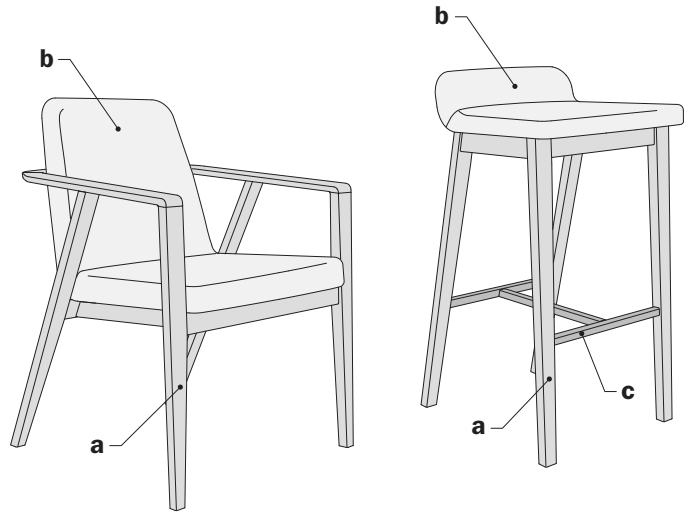

Dual Textile Seating

a. frame species

(choose one)

- maple
- walnut (*upcharge applies*)

finish color:

(see previous page for finish choices) _____

b. fabric selection;

b1.) seat and lower back

- vendor
- pattern
- color

b2.) upper back

- vendor
- pattern
- color

(see pages 12-20 in JSI Seating price list for fabric choices) _____

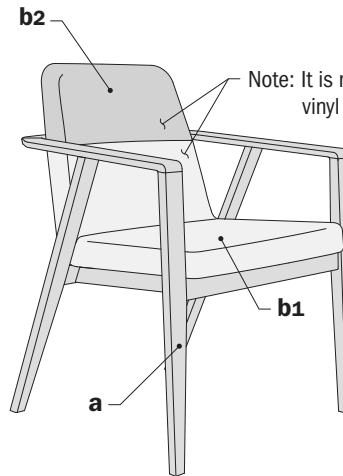

Note: It is not recommended to combine vinyl or leather material to fabric.

Bourne Seating Product Information

Exterior Wood Materials

All materials used in our guest seating are kiln dried lumber from suppliers practicing forest sustainability. Any defects in the wood that are removed during our process are utilized in other areas of production.

Interior Frame Materials

A combination of materials are used to create interior frame components, including solid lumber, plywood, metal plates, and high grade upholstery board.

Metal Materials

Stool and foot rail are fabricated from 14 gauge steel tubing and welded to pre-set standards.

Construction

Tenon style joinery is used in most frame construction for our seating products; however, dowel pin joinery may also be used. Engineering will determine, based on design which joinery is best for the frame design of each particular design. Critical joints are reinforced with mechanical fastening.

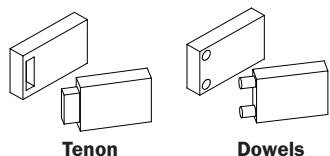

Finish

Each of the wood components that goes into a chair will have unique characteristic; the process of shaping and machining these parts may expose additional natural characteristics. To accentuate the beauty of the wood, special care is taken in selecting the frame component for each finish color.

Finish colors may vary slightly when comparing solid wood product finish to our casegoods veneer product finish. Exceptional care is taken to assure a uniform color on solid wood products.

Seating Finishes

ALE	Ale	FLX	Flax
AUB	Auburn	LGC	Legacy
AUT	Autumn	MCH	Mocha
BRL	Barley	NTO	Night Owl
BBN	Bourbon	PRL	Praline
BRG	Brighton	SAF	Saffron
BUT	Butterscotch	SIE	Sienna
CIN	Cinnamon	TOF	Toffee
CLA	Classic	TRF	Truffle
EAR	Earthy	VEN	Venetian
ESP	Espresso		

Color Coordinates

Color Coordinate Finishes are intended to coordinate with select laminate and double cut veneer casegood finishes. They represent an average color and do not match the grain pattern of the coordinating laminate or double cut veneer.

CBE	Blonde Echo Coordinate	CHL	High Line Coordinate
CBZ	Brazilwood Coordinate	KKC	Khaki Coordinate
CCF	Coffee Coordinate	CST	Studio Teak Coordinate
CCR	Cremello Coordinate	CVI	Vintage Coordinate
CGR	Graphite Coordinate	CWH	Walnut Heights Coordinate

Not all finishes are available in every seating series. Reference the Order Check List at the beginning of each series.

Protective Top Coat

We are proud that our finish is GreenGuard certified. To reduce hazardous formaldehyde emission we use our proprietary specially designed top coat, DuraTex™. Our DuraTex™ top coat offers exceptional hardness along with abrasion and impact resistance, but has been formulated to eliminate the hazardous and harmful gases that are normally associated with wood finish.

DuraTex™ Features

Safety - Significantly reduces hazardous formaldehyde emissions which help improve the quality of the of the indoor air we breathe.

Quality - Developed to be tough and durable with special attention to appearance. The DuraTex™ finish provides a safe solution and still preserves the natural beauty of wood.

Durability - Designed to meet a wide range of demanding performance and environmental standards to withstand even the highest wear and tear.

Bourne Seating Product Information

Upholstery Cover Application

Unless a customer specifies the fabric to be run "railroad", the fabric will be "cut up the roll". Additional seaming may be needed, pending fabric width and textile repeat match, contact Customer Service with questions.

"Nap" or "Up the Roll" (standard)

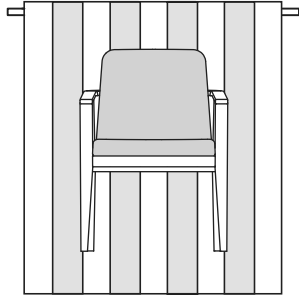

Railroaded (upon request)

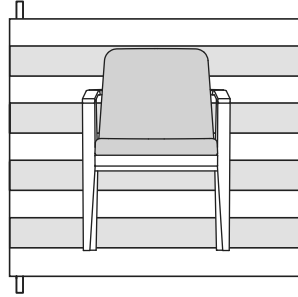

Care of Upholstery Surfaces

Cleanability will vary based on the fabric type. For best results, a professional service is recommended. Dirt and crumbs may be gently brushed or vacuumed off. Spills should be wiped up immediately with a cloth. Vinyl textiles can be cleaned with warm soapy water and wiped down with a warm damp cloth. For more details on any JSI carded fabric and vinyl, please visit our website at jsifurniture.com or consult the back of the appropriate swatch card for cleaning codes and any specific instructions. For COM materials, consult with the individual textile manufacturer for cleaning codes and any specific instructions pertaining to your particular fabric.

Care of Wood Edges and Veneer Surfaces

Clean all surfaces frequently with water dampened soft cloth, moving the cloth with the grain direction. Immediately remove any liquids that come in contact with wood surfaces, with a blotting action to absorb liquid. Buff dry. Lift objects to move them, never pull them across the finished surface. Avoid exposure of furniture to extremes of heat, cold, and wide variance of humidity. Avoid exposure of furniture to strong sunlight. Avoid exposure of furniture to harsh solvents such as nail polish remover, acetates, etc., as it will cause finish deterioration.

Metal Components

Wipe smooth powder coat finishes and textured metals with a damp cloth. For stubborn stains and grease marks, use soap and water. Lightly brush textured metals with a soft, dry brush to remove dirt.

Bourne Tables Order Check List:



Specify:

- 1. Model Number
- 2. Top Material
 - a.) Veneer
 - 1.) Wood Species - Cherry (CH1), Maple (MA1), Walnut (WA1) or Double Cut (DC1)
 - 2.) Wood Finish
 - b.) Laminate
 - 1.) Laminate Color
 - c.) Solid Surface
 - 1.) Solid Surface Color - Pebble Pearl (PEB), Pure White (PUR) or Saddlebow Gray (SDB)
- 3. Legs/Apron Wood Species
 - a.) Maple (M)
 - 1.) Wood or Paint Color
 - b.) Walnut (W) (upcharge applies)
 - 1.) Wood Finish
- 4. Metal Legs/Foot Rail Color - Arctic Silver (ASL), Matte Black (MBK), Pewter (PEW) or Soft Nickel (SNK)
- 5. Optional Accessory Hooks - four hooks; specify and add \$140 list
- 6. Optional Power Unit - units must be ordered separately
 - EC26 - worksurface power, specify cut-out on order - specify Black (B), or White (W)
 - EC27 - under surface power - specify Black (B), or White (W)

Example:

BU4272-30TTML (model #)	WA1 (veneer species)	MCH (wood finish)	W (legs/apron species)	ESP (wood finish)	ASL (metal color)
-----------------------------------	--------------------------------	-----------------------------	----------------------------------	-----------------------------	-----------------------------

1. Model Number

2. Top Material Selection:

Veneer

	<i>Flat Cut</i>	
Cherry (CH1)	Maple (MA1)	Walnut (WA1)
AUT Autumn	ALE Ale	AUB Auburn
BRL Barley	BUT Butterscotch	ESP Espresso
BBN Bourbon	CIN Cinnamon	MCH Mocha
BRG Brighton	FLX Flax	NTO Night Owl
CLA Classic	VEN Venetian	SIE Sienna
EAR Earthy		TOF Toffee
LGC Legacy		TRF Truffle
PRL Praline		
SAF Saffron		

Double Cut (DC1)

COF Coffee
CRM Cremello
GRH Graphite
KHK Khaki
STU Studio Teak

Top Material Selection (continued):

Laminate

Veneer Grain Pattern Laminates

AUB Auburn	CLA Classic	SHE Shea
AUT Autumn	GRH Graphite	SIE Sienna
BRL Barley	HGL High Line	STU Studio Teak
BLO Blonde Echo	LGC Legacy	TOF Toffee
BBN Bourbon	MCH Mocha	TRF Truffle
BZW Brazilwood	NTO Night Owl	VEN Venetian
BRG Brighton	PRL Praline	VIN Vintage
CIN Cinnamon	SAF Saffron	WLH Walnut Heights

Solid Laminates

ALB Alabaster	SHD Shadow
BBL Bridal Blanco	SLG Slate Grey
DWH Designer White	TAU Taupe
DOV Dove Grey	

Solid Surface

PEB Pebble Pearl
PUR Pure White
SDB Saddlebow Gray

BOURNE

3. Legs/Apron Selection:

Maple (MA1)

Wood Finish:

ALE Ale	CGR Graphite Coordinate
AUB Auburn	CHL High Line Coordinate
AUT Autumn	CKC Khaki Coordinate
BRL Barley	LGC Legacy
CBE Blonde Echo Coordinate	MCH Mocha
BBN Bourbon	NTO Night Owl
CBZ Brazilwood Coordinate	PRL Praline
BRG Brighton	SAF Saffron
BUT Butterscotch	SIE Sienna
CIN Cinnamon	CST Studio Teak Coordinate
CLA Classic	TOF Toffee
CCF Coffee Coordinate	TRF Truffle
CCR Cremello Coordinate	VEN Venetian
EAR Earthy	CVI Vintage Coordinate
ESP Espresso	CWH Walnut Heights Coordinate
FLX Flax	

Paint Color:

BKD Backdrop	GRV Greek Villa
BFX Black Fox	NET Network Gray
BWH Bright White	NWH Nonchalant White
CGP Cargo Pants	STM Storm
CHT Chatroom	TRC Tricorn Black
FRR French Roast	

Walnut (WA1) (upcharge applies)

Wood Finish:

AUB Auburn	SIE Sienna
ESP Espresso	TOF Toffee
MCH Mocha	TRF Truffle
NTO Night Owl	

4. Metal Legs/Foot Rail Color:

ASL Arctic Silver	PEW Pewter
MBK Matte Black	SNK Soft Nickel

5. Optional Accessory Hooks - four hooks; specify and add \$140 list

6. Power Unit - Power Units can be specified

Worksurface - EC26 - Two 110 outlets and a dual USB port with a 120" power cord - Black (B) or White (W);see page 33.

Under Surface - EC27 - Two 110 outlets and a dual USB port with a 120" power cord - Black (B) or White (W);see page 33.

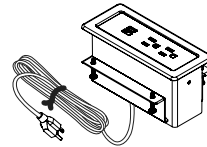

EC26

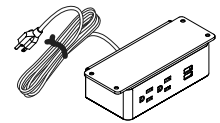

EC27

Table Order Check List

a. worksurface - veneer, laminate, or solid surface choice
(choose one)

- cherry
- maple
- walnut
- double cut
- laminate
- solid surface

finish, laminate or solid surface color:
(see previous page for choices) _____

b. legs/apron
(choose one)

- maple
- walnut (upcharge applies)

legs/apron finish/paint color:
(see above for choices) _____

c. metal legs/foot rail color (if applicable)
(choose one)

- arctic silver
- matte black
- pewter
- soft nickel

d. optional accessory hooks (add \$140 list)
 four hooks

e. optional power units
 EC26 - worksurface power unit; must be ordered separately
 EC27 - under surface power unit; must be ordered separately

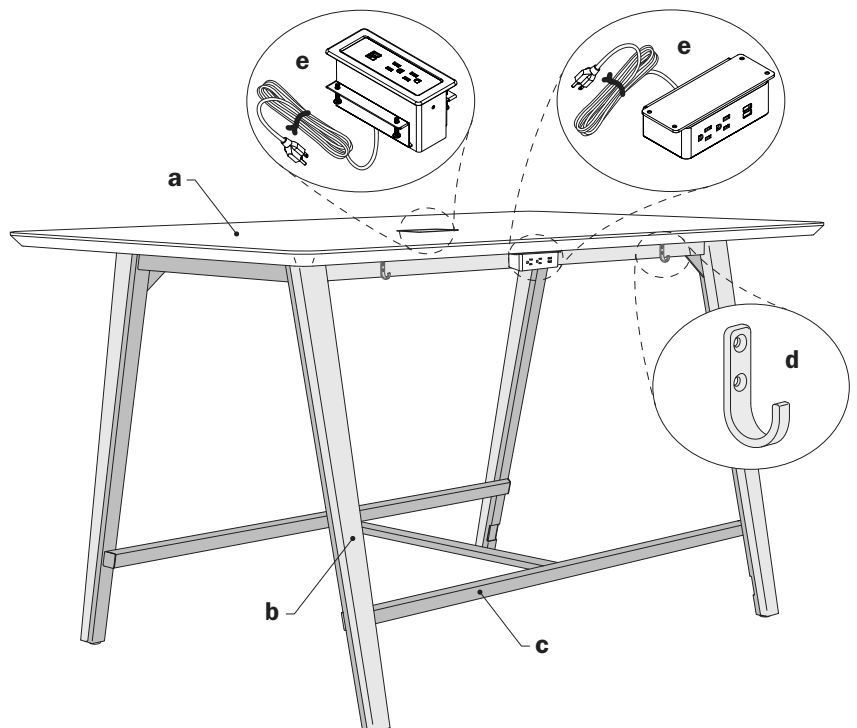

Bourne Storage Order Check List:



Specify:

- 1. Model Number
- 2. Chassis Species - Cherry (CH1), Maple (MA1), Walnut (WA1) or Double Cut (DC1)
- 3. Base Wood Species:
 - a.) Maple (M) - Standard (finish will be same as chassis)
 - b.) Walnut (W) - Upcharge Applies (only available when walnut chassis is specified, finish will be same as chassis)
- 4. Chassis/Base Finish
- 5. Door Finish
 - a.) Same as Chassis
 - b.) Paint
 - 1.) Paint Color

Examples:

BU1830-42STWL | **MA1** | **M** | **ALE** | **NET**
 (model #) | (chassis species) | (base species) | (chassis/base finish) | (door paint color)

1. Model Number

2. Chassis Species:

- | | | |
|-------------------------|--------------------|---------------------|
| | <i>Flat Cut</i> | |
| Cherry (CH1) | Maple (MA1) | Walnut (WA1) |
| AUT Autumn | ALE Ale | AUB Auburn |
| BRL Barley | BUT Butterscotch | ESP Espresso |
| BBN Bourbon | CIN Cinnamon | MCH Mocha |
| BRG Brighton | FLX Flax | NTO Night Owl |
| CLA Classic | VEN Venetian | SIE Sienna |
| EAR Earthy | | TOF Toffee |
| LGC Legacy | | TRF Truffle |
| PRL Praline | | |
| SAF Saffron | | |
| Double Cut (DC1) | | |
| COF Coffee | | |
| CRM Cremello | | |
| GRH Graphite | | |
| KHK Khaki | | |
| STU Studio Teak | | |

3. Base Wood Species:

Maple (MA1)
Wood Finish:
 Same as Chassis

Walnut (WA1) (upcharge applies)
Wood Finish:
 Same as Chassis

4. Chassis/Base Finish:

Wood Finish:
 See list of finishes under **2. Chassis Species**
 (Base Finish same as Chassis)

5. Door Finish Selection:

Wood Finish:
Same as Chassis

Paint Color:

BKD Backdrop	GRV Greek Villa
BFX Black Fox	NET Network Gray
BWH Bright White	NWH Nonchalant White
CGP Cargo Pants	STM Storm
CHT Chatroom	TRC Tricorn Black
FRR French Roast	

Storage Order Check List

a. chassis species
 (choose one)

- cherry
- maple
- walnut
- double cut

finish color:
 (see previous page for finish choices) _____

b. base species
 (choose one)

- maple (*finish will be same as chassis*)
- walnut (*upcharge applies*) (*only available when walnut chassis is specified, finish will be same as chassis*)

c. door finish
 (choose one)

- same as chassis

paint color:
 (see previous page for choices) _____

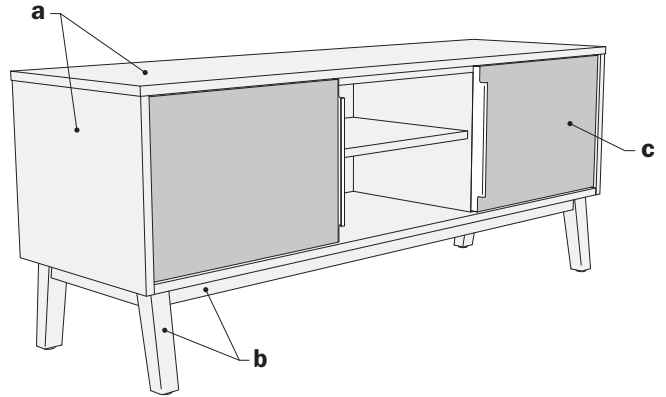

Bourne Tables and Storage Product Information

Exterior Wood Materials

Exterior surfaces are made from the finest selected veneers to achieve clarity and consistency in the Bourne product line. To attain a pleasing, symmetrical pattern, all veneers in Bourne are book-matched. All exterior solid lumber is matched to coordinate with the veneer.

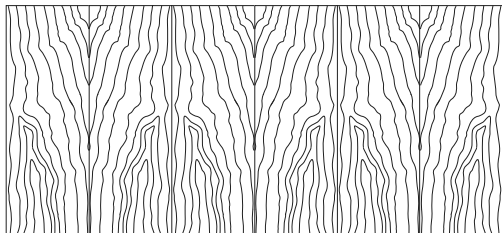

Book Matched Example

Alternating pieces of veneer are flipped over so they face each other like the pages within a book.

Bourne is available in flat cut cherry, maple and walnut veneer. A wide range of wood stains have been formulated to enhance the beauty of the veneer.

Double Cut veneer is another choice on Bourne Veneer product. This veneer is a processed product that has at least two cuttings to create the final veneers. These cuts of veneer strands are dyed and layered into a block to create variation of patterns from a very tight grain pattern to an exotic figure grain pattern.

The diagram below shows the tight pattern used on Bourne Double Cut Veneer.

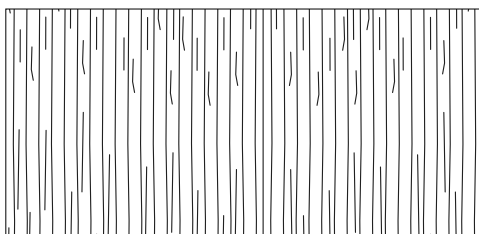

Worksurface Construction

Veneer and Laminate Worksurface

Worksurfaces are 1 3/8" thick and are manufactured with 3-ply balanced construction. Surfaces are available in wood veneer or high pressure laminate. MDF edges on table tops have an undercut bevel profile and are painted to match top.

Solid Surface Worksurface

Solid surface worksurfaces are constructed with a 1/2" thick solid surface top and a 1/16" thick wood sub-top. Total thickness of this mixed material worksurface is 1 3/8". MDF edges on sub-top have an undercut bevel profile and are painted to match top.

Casework Construction

Casework tops are made up of layers of hardwood veneers molded to shape and RF cured. Outer veneers are matched for uniform grain patterns. All casework tops are 3/4" thick plywood.

Casework chassis, doors and drawer fronts consist of veneer over composite wood core; all wood core components are 3/4" thick.

Cabinet doors have 110° swing hinges to allow adequate access into the interior of the cabinet.

Drawers

The 9ply unidirectional hardwood sides of the drawer box are 7/16" thick assembled with English dovetail construction at each corner of the box. The drawer bottom panel is 1/4" thick fitting into a groove machined into the side of the box. Interiors are sanded and coated with clear U.V. finish to protect against shrinking, swelling or warping, and to provide a clean, smooth feel and appearance.

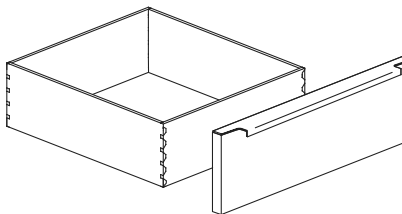

Drawer Suspension

The high quality black drawer suspensions carry a lifetime warranty. Slides feature steel ball bearings for longer life with cushioned in/out stops. File and box drawers have 100% full extension with over travel.

Finish - Stain/Colors

We offer a variety of wood stains and paint colors on Bourne. Please see the chart below. Samples are available upon request.

CH1 Cherry

Flat Cut Veneer

AUT Autumn	EAR Earthy
BRL Barley	LGC Legacy
BBN Bourbon	PRL Praline
BRG Brighton	SAF Saffron
CLA Classic	

MA1 Maple

Flat Cut Veneer

ALE Ale	FLX Flax
BUT Butterscotch	VEN Venetian
CIN Cinnamon	

WA1 Walnut

Flat Cut Veneer

AUB Auburn	SIE Sienna
ESP Espresso	TOF Toffee
MCH Mocha	TRF Truffle
NTO Night Owl	

DC1 Double Cut Veneer

COF Coffee	KHK Khaki
CRM Cremello	STU Studio Teak
GRH Graphite	

PNT Paint

BKD Backdrop	GRV Greek Villa
BFX Black Fox	NET Network Gray
BWH Bright White	NWH Nonchalant White
CGP Cargo Pants	STM Storm
CHT Chatroom	TRC Tricorn Black
FRR French Roast	

Bourne Tables and Storage Product Information

Protective Top Coat

DuraTex™ offers exceptional hardness along with abrasion and impact resistance, it has been formulated to eliminate hazardous and harmful gases that are normally associated with wood finish.

DuraTex™ Features

Safety - Significantly reduces hazardous formaldehyde emissions, which help improve the quality of the indoor air we breathe.

Quality - Developed to be tough and durable with special attention to appearance. The DuraTex™ finish preserves the natural beauty of wood.

Durability - Designed to meet a wide range of demanding performance and environmental standards to withstand even the highest wear and tear.

To reduce hazardous formaldehyde emission we use our proprietary specially design top coat, DuraTex™. We are proud that our finish is GreenGuard certified.

Care of Wood Edges and Veneer Surfaces

Clean all surfaces frequently with water dampened soft cloth, moving the cloth with the grain direction. Immediately remove any liquids that come in contact with wood surfaces, with a blotting action to absorb liquid. Buff dry. Lift objects to move them, never pull them across the finished surface. Avoid exposure of furniture to extremes of heat, cold, and wide variance of humidity. Avoid exposure of furniture to strong sunlight. Avoid exposure of furniture to harsh solvents such as nail polish remover, acetates, etc., as it will cause finish deterioration.

Metal Components

Wipe smooth powder coat finishes and textured metals with a damp cloth. For stubborn stains and grease marks, use soap and water. Lightly brush textured metals with a soft, dry brush to remove dirt.

Top Edge Details

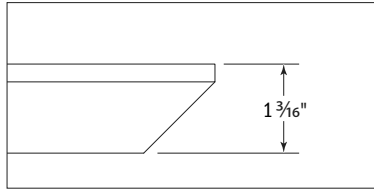

Knife Edge - Veneer & Laminate

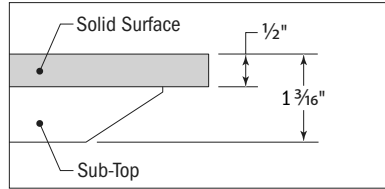

Painted Knife Edge with Solid Surface Top

Optional Power Units

Worksurface Surface Power

Optional Worksurface Power (EC26) is available on standard, counter and bar height tables. Indicate "to accommodate Worksurface Power" on your purchase order. When this option is specified the worksurface will have one cut out in the center. One EC26 Worksurface Power unit must be ordered separately, see page 33. Length of cord is 10 feet.

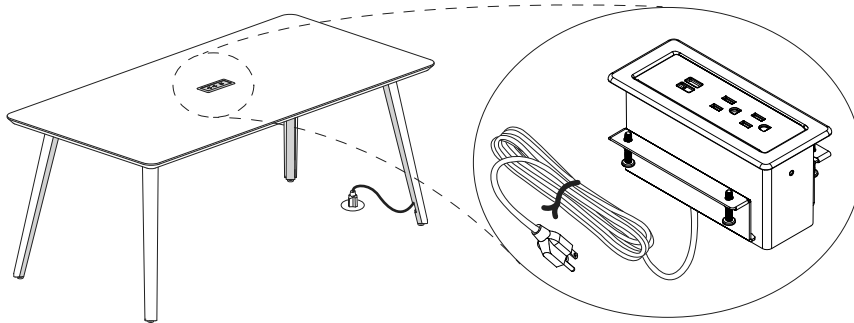

Under Surface Power

Under Surface Power (EC27) may be ordered for standard, counter and bar height tables. The EC27 Under Surface Power Unit(s) must be ordered separately, see page 33. This unit is field installed. Length of cord is 10 feet.

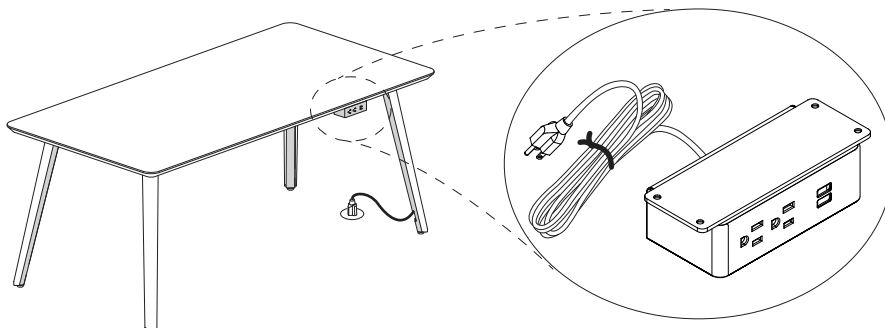

Bourne Tables and Casework Product Information

Wire Management - Standard and Counter Height Tables

Standard and counter height tables with metal legs contain one leg with a wire management channel/exit cutout which is accessed and concealed with a wood cap. This wire management leg can be attached to any corner of the table during assembly. Predetermining which corner of table cord exit is desired and assembly accordingly.

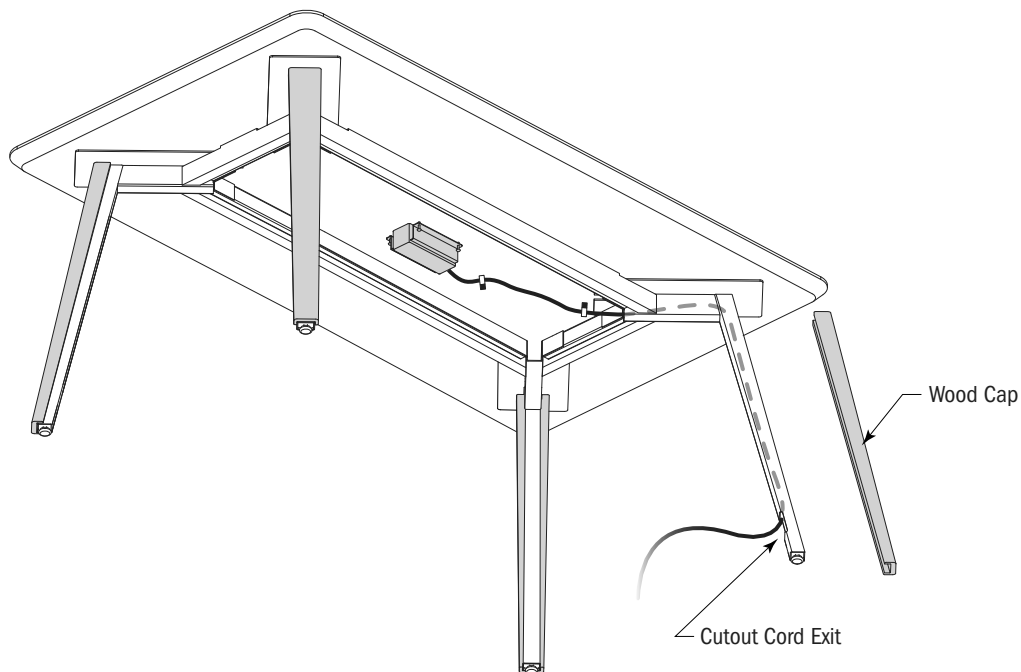

Wire Management - Bar Height Tables

Bar height tables with metal legs has a set of legs on one side of table with wire management channel and exit cutout. The management channels are accessed and concealed with wood caps.

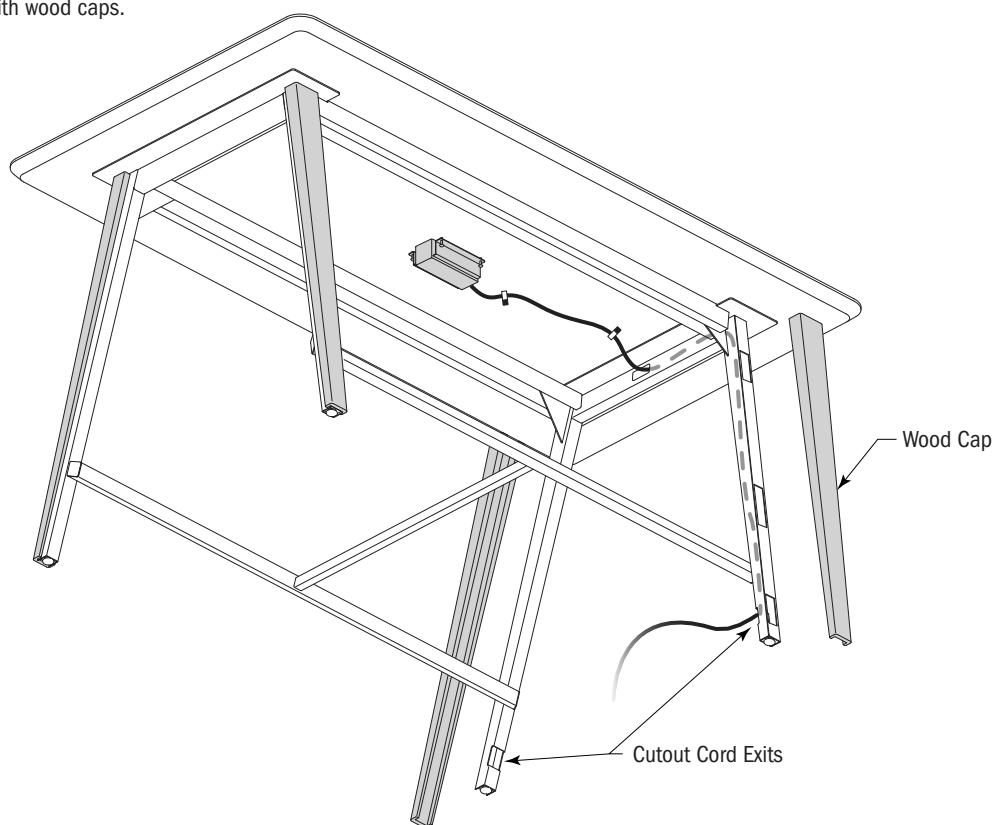

BOURNE

Bourne Tables and Casework Product Information

Optional Accessory Hooks

Optional satin stainless steel accessory hooks are available on the 30"h, 36"h and 40"h tables.

Four Hooks - add \$140 list

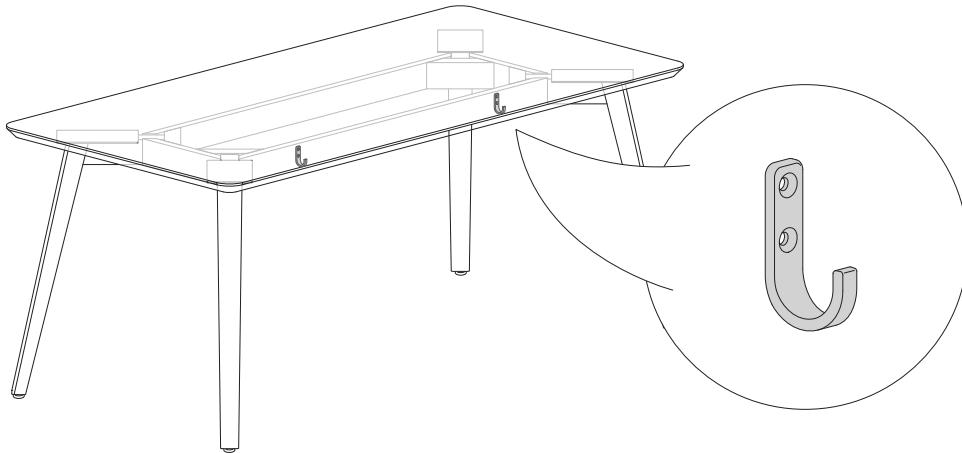

Integrated Metal Pull

Storage Units offer integrated clear anodized aluminum pulls standard.

Low Storage

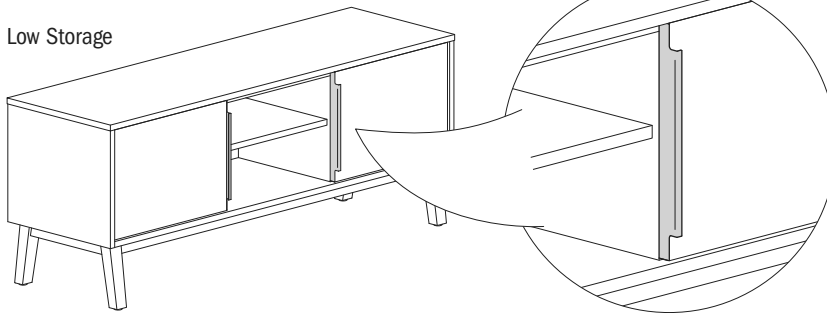

Tall Storage

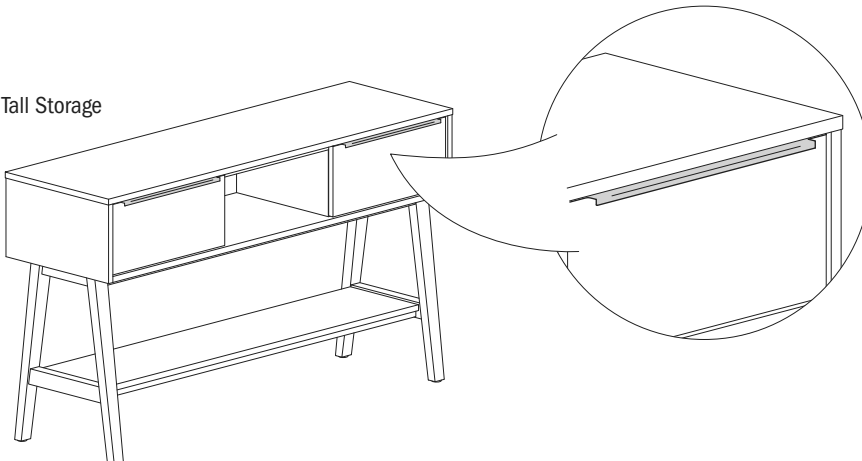

Bourne Product Information

Product Overview

Seating



Guest Chair
Single Fabric



Guest Chair
Dual Fabric



Lounge Chair
Single Fabric



Lounge Chair
Dual Fabric



Ottoman



Counter Height
Stool



Bar Stool

Standard and Counter Height Tables

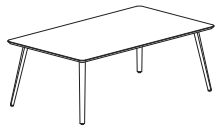

Rectangular Table
with Wood Legs



Racetrack Table
with Wood Legs



Square Table
with Wood Legs



Round Table
with Wood Legs

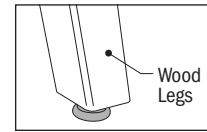

Rectangular Table
with Wood/Metal Legs



Racetrack Table
with Wood/Metal Legs



Square Table
with Wood/Metal Legs



Round Table
with Wood/Metal Legs

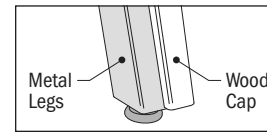

Bar Height Tables

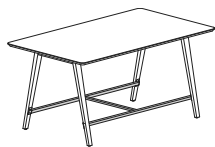

Rectangular Table with Wood Legs

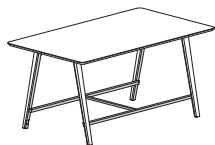
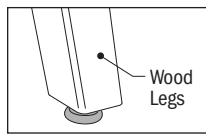

Rectangular Table with Wood/Metal Legs

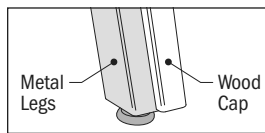

Occasional Tables



Rectangular
Coffee Table



Square
Coffee Table



Round
Coffee Table



Triangular
Coffee Table



Square
Side Table



Round
Side Table

Storage

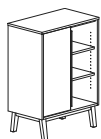

Tall Storage



Mid Storage

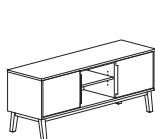

Low Storage

Bourne Product Information

Table Heights

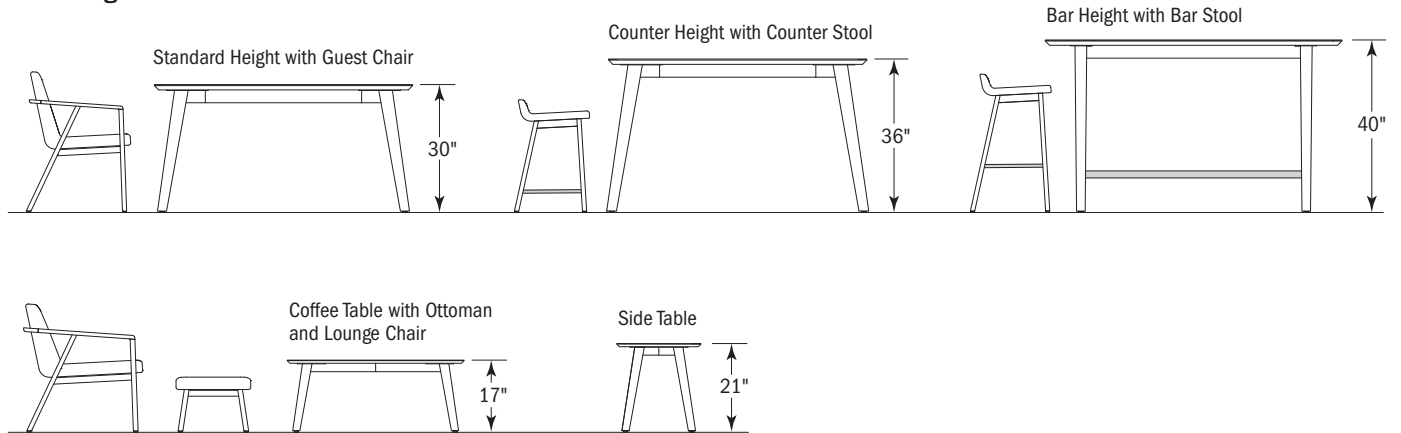
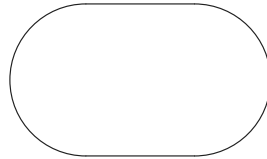

Table Shapes



rectangular

sizes available:
 48" x 90" 42" x 90"
 48" x 84" 42" x 84"
 48" x 72" 42" x 72" 36" x 72"



racetrack

sizes available:
 48" x 90" 42" x 90"
 48" x 84" 42" x 84"
 48" x 72" 42" x 72"
 42" x 60"

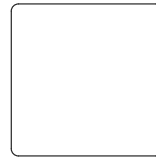

square

sizes available:
 60" x 60"
 48" x 48"
 42" x 42"

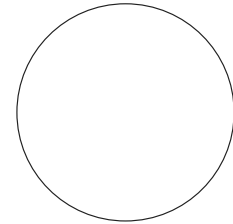

round

size: 60" dia.

Coffee Table Shapes



rectangular

size: 24" x 48"



square

size: 42" x 42"

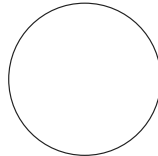

round

sizes available:
 42" dia.
 36" dia.

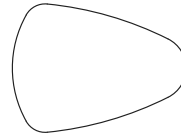

triangular

size: 36" x 48"

Side Table Shapes



square

size: 20" x 20"



round

size: 24" dia.

**Typicals:
BU001**

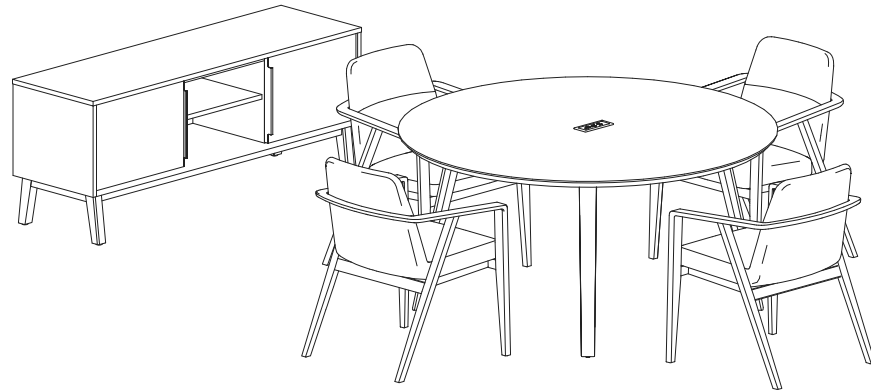
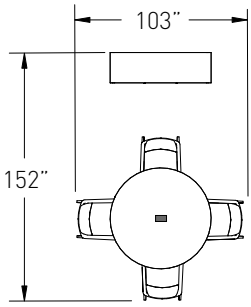

Total List: **\$11,357**

Models

- (1) BU60-30RDML (1) BU1860-24SCHD
- (4) BU7511E (1) EC26

* Typical priced with maple wood species and COM fabric grade.

BU002

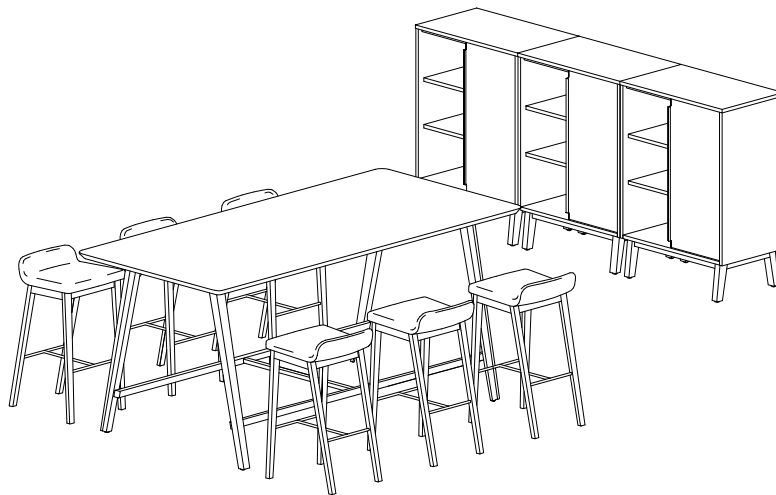
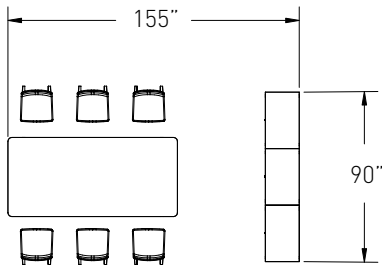

Total List: **\$17,913**

Models

- (1) BU4290-40TTMLH
- (6) BU7518D
- (3) BU1830-42STWR

* Typical priced with maple wood species and COM fabric grade.

BU003

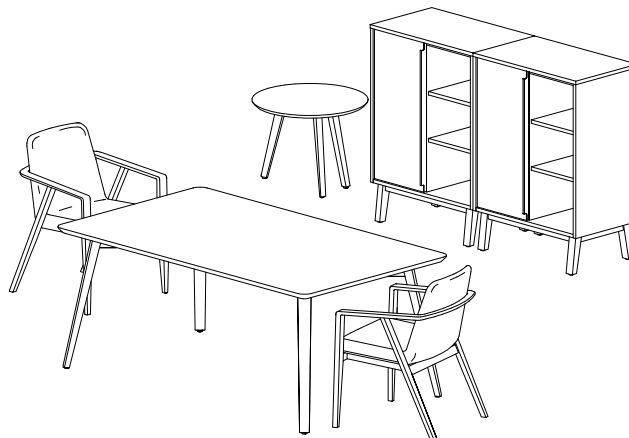
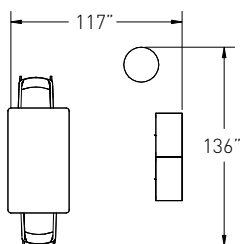

Total List: **\$10,293**

Models

- (1) BU4272-30TTWL (2) BU1830-42STWL
- (2) BU7511D (1) BU24-21RDWL

* Typical priced with maple wood species and COM fabric grade.

**Typicals:
BU004**

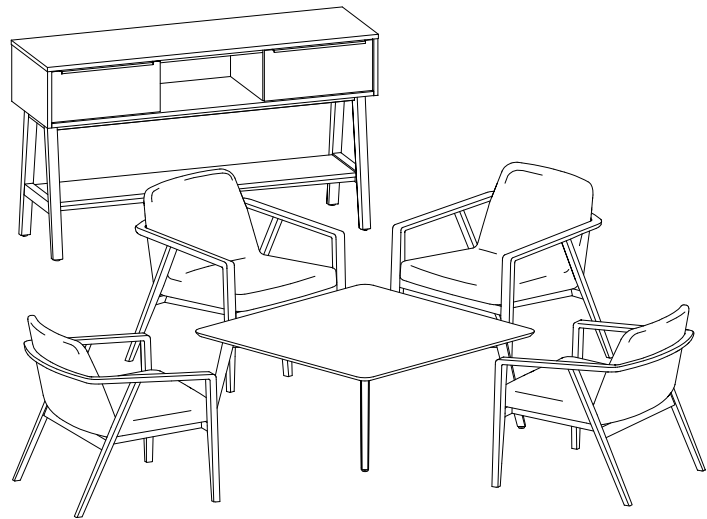
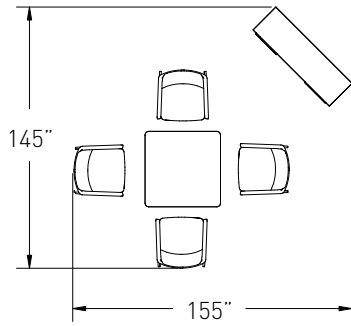

Total List: **\$9,196**

Models

- (1) BU4242-17TTWL
- (4) BU7521D
- (1) BU1860-34SCD

* Typical priced with maple wood species and COM fabric grade.

BU005

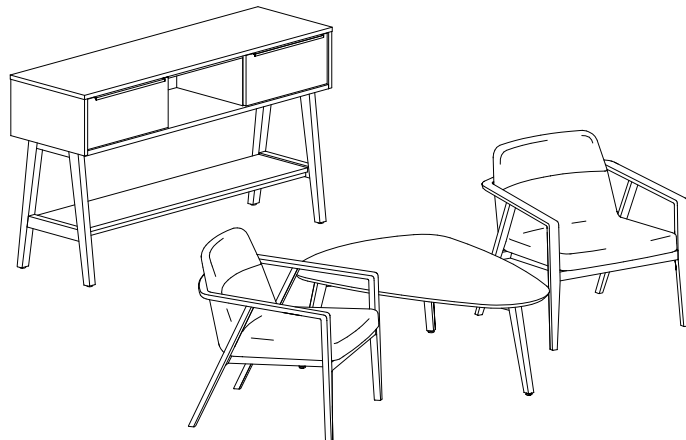
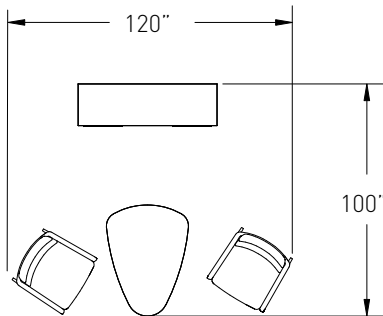

Total List: **\$6,664**

Models

- (1) BU3648-17PKWL
- (2) BU7521E
- (1) BU1860-34SCD

* Typical priced with maple wood species and COM fabric grade.

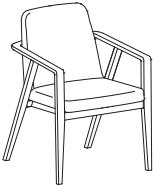
Description	Model	Specifications	List Price Per Grade																
Guest Chair - Single Textile 	BU7511D · wall saver · maple frame standard · walnut frame available, specify and add \$180 list	<table border="1"> <thead> <tr> <th>Dimensions</th> <th>D</th> <th>W</th> <th>H</th> </tr> </thead> <tbody> <tr> <td>Overall</td> <td>26</td> <td>24 ¼</td> <td>33</td> </tr> <tr> <td>Seat</td> <td>18</td> <td>20 ¼</td> <td>18</td> </tr> <tr> <td>Arm</td> <td></td> <td></td> <td>25</td> </tr> </tbody> </table>	Dimensions	D	W	H	Overall	26	24 ¼	33	Seat	18	20 ¼	18	Arm			25	COM \$1,092 A \$1,107 B \$1,136 COL/C \$1,188 D \$1,254 E \$1,321 F \$1,424 G \$1,534 H \$1,652 I \$1,837 J \$2,058 L1 \$1,615 L2 \$1,763
		Dimensions	D	W	H														
Overall	26	24 ¼	33																
Seat	18	20 ¼	18																
Arm			25																
<table border="1"> <thead> <tr> <th>Upholstery</th> <th colspan="3">Shipping</th> </tr> </thead> <tbody> <tr> <td>COM Ydg</td> <td>1 ¼</td> <td>Ctn Wt</td> <td>25</td> </tr> <tr> <td>COL Sq Ft</td> <td>23</td> <td>Cu Ft</td> <td>14</td> </tr> </tbody> </table>	Upholstery	Shipping			COM Ydg	1 ¼	Ctn Wt	25	COL Sq Ft	23	Cu Ft	14							
Upholstery	Shipping																		
COM Ydg	1 ¼	Ctn Wt	25																
COL Sq Ft	23	Cu Ft	14																

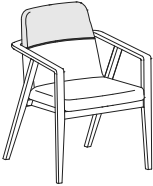
Description	Model	Specifications	List Price Per Grade																
Guest Chair - Dual Textile 	BU7511E · wall saver · dual textile back; specify two textiles when ordering, see page 3 · maple frame standard · walnut frame available, specify and add \$180 list	<table border="1"> <thead> <tr> <th>Dimensions</th> <th>D</th> <th>W</th> <th>H</th> </tr> </thead> <tbody> <tr> <td>Overall</td> <td>26</td> <td>24 ¼</td> <td>33</td> </tr> <tr> <td>Seat</td> <td>18</td> <td>20 ¼</td> <td>18</td> </tr> <tr> <td>Arm</td> <td></td> <td></td> <td>25</td> </tr> </tbody> </table>	Dimensions	D	W	H	Overall	26	24 ¼	33	Seat	18	20 ¼	18	Arm			25	COM \$1,142 A \$1,162 B \$1,201 COL/C \$1,270 D \$1,358 E \$1,447 F \$1,585 G \$1,732 H \$1,889 I \$2,135 J \$2,430 L1 \$1,840 L2 \$2,037
		Dimensions	D	W	H														
Overall	26	24 ¼	33																
Seat	18	20 ¼	18																
Arm			25																
<table border="1"> <thead> <tr> <th>Upholstery</th> <th colspan="3">Shipping</th> </tr> </thead> <tbody> <tr> <td>COM Ydg</td> <td>1 ½</td> <td>Ctn Wt</td> <td>25</td> </tr> <tr> <td>COL Sq Ft</td> <td>27</td> <td>Cu Ft</td> <td>14</td> </tr> </tbody> </table>	Upholstery	Shipping			COM Ydg	1 ½	Ctn Wt	25	COL Sq Ft	27	Cu Ft	14							
Upholstery	Shipping																		
COM Ydg	1 ½	Ctn Wt	25																
COL Sq Ft	27	Cu Ft	14																

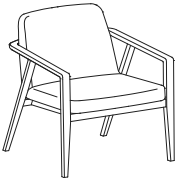
Description	Model	Specifications	List Price Per Grade																
Lounge Chair - Single Textile 	BU7521D · maple frame standard · walnut frame available, specify and add \$225 list	<table border="1"> <thead> <tr> <th>Dimensions</th> <th>D</th> <th>W</th> <th>H</th> </tr> </thead> <tbody> <tr> <td>Overall</td> <td>29 ¼</td> <td>28 ¾</td> <td>30</td> </tr> <tr> <td>Seat</td> <td>21</td> <td>24 ½</td> <td>17 ¼</td> </tr> <tr> <td>Arm</td> <td></td> <td></td> <td>23</td> </tr> </tbody> </table>	Dimensions	D	W	H	Overall	29 ¼	28 ¾	30	Seat	21	24 ½	17 ¼	Arm			23	COM \$1,287 A \$1,304 B \$1,339 COL/C \$1,399 D \$1,476 E \$1,554 F \$1,674 G \$1,803 H \$1,941 I \$2,156 J \$2,414 L1 \$1,898 L2 \$2,070
		Dimensions	D	W	H														
Overall	29 ¼	28 ¾	30																
Seat	21	24 ½	17 ¼																
Arm			23																
<table border="1"> <thead> <tr> <th>Upholstery</th> <th colspan="3">Shipping</th> </tr> </thead> <tbody> <tr> <td>COM Ydg</td> <td>1 ½</td> <td>Ctn Wt</td> <td>30</td> </tr> <tr> <td>COL Sq Ft</td> <td>30</td> <td>Cu Ft</td> <td>17</td> </tr> </tbody> </table>	Upholstery	Shipping			COM Ydg	1 ½	Ctn Wt	30	COL Sq Ft	30	Cu Ft	17							
Upholstery	Shipping																		
COM Ydg	1 ½	Ctn Wt	30																
COL Sq Ft	30	Cu Ft	17																

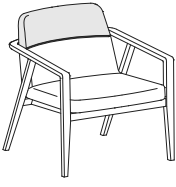
Description	Model	Specifications	List Price Per Grade																
Lounge Chair - Dual Textile 	BU7521E · dual textile back; specify two textiles when ordering, see page 3 · maple frame standard · walnut frame available, specify and add \$225 list	<table border="1"> <thead> <tr> <th>Dimensions</th> <th>D</th> <th>W</th> <th>H</th> </tr> </thead> <tbody> <tr> <td>Overall</td> <td>29 ¼</td> <td>28 ¾</td> <td>30</td> </tr> <tr> <td>Seat</td> <td>21</td> <td>24 ½</td> <td>17 ¼</td> </tr> <tr> <td>Arm</td> <td></td> <td></td> <td>23</td> </tr> </tbody> </table>	Dimensions	D	W	H	Overall	29 ¼	28 ¾	30	Seat	21	24 ½	17 ¼	Arm			23	COM \$1,339 A \$1,361 B \$1,406 COL/C \$1,483 D \$1,582 E \$1,682 F \$1,837 G \$2,003 H \$2,180 I \$2,456 J \$2,788 L1 \$2,124 L2 \$2,346
		Dimensions	D	W	H														
Overall	29 ¼	28 ¾	30																
Seat	21	24 ½	17 ¼																
Arm			23																
<table border="1"> <thead> <tr> <th>Upholstery</th> <th colspan="3">Shipping</th> </tr> </thead> <tbody> <tr> <td>COM Ydg</td> <td>1 ¾</td> <td>Ctn Wt</td> <td>30</td> </tr> <tr> <td>COL Sq Ft</td> <td>35</td> <td>Cu Ft</td> <td>17</td> </tr> </tbody> </table>	Upholstery	Shipping			COM Ydg	1 ¾	Ctn Wt	30	COL Sq Ft	35	Cu Ft	17							
Upholstery	Shipping																		
COM Ydg	1 ¾	Ctn Wt	30																
COL Sq Ft	35	Cu Ft	17																

Description	Model	Specifications	List Price Per Grade								
Ottoman 	BU7504C · maple frame standard · walnut frame available, specify and add \$75 list	<table border="1"> <thead> <tr> <th>Dimensions</th> <th>D</th> <th>W</th> <th>H</th> </tr> </thead> <tbody> <tr> <td>Overall</td> <td>18</td> <td>22</td> <td>13 ¼</td> </tr> </tbody> </table>	Dimensions	D	W	H	Overall	18	22	13 ¼	COM \$727 A \$734 B \$749 COL/C \$775 D \$808 E \$841 F \$893 G \$948 H \$1,007 I \$1,099 J \$1,210 L1 \$989 L2 \$1,062
		Dimensions	D	W	H						
Overall	18	22	13 ¼								
<table border="1"> <thead> <tr> <th>Upholstery</th> <th>Shipping</th> </tr> </thead> <tbody> <tr> <td>COM Ydg ¾</td> <td>Ctn Wt 10</td> </tr> <tr> <td>COL Sq Ft 14</td> <td>Cu Ft 5</td> </tr> </tbody> </table>	Upholstery	Shipping	COM Ydg ¾	Ctn Wt 10	COL Sq Ft 14	Cu Ft 5					
Upholstery	Shipping										
COM Ydg ¾	Ctn Wt 10										
COL Sq Ft 14	Cu Ft 5										

Description	Model	Specifications	List Price Per Grade												
Counter Height Stool 	BU7514D · coordinates with counter height tables · metal foot rail · maple frame standard · walnut frame available, specify and add \$135 list	<table border="1"> <thead> <tr> <th>Dimensions</th> <th>D</th> <th>W</th> <th>H</th> </tr> </thead> <tbody> <tr> <td>Overall</td> <td>18 ¼</td> <td>18</td> <td>27 ½</td> </tr> <tr> <td>Seat</td> <td>14 ½</td> <td>18</td> <td>24</td> </tr> </tbody> </table>	Dimensions	D	W	H	Overall	18 ¼	18	27 ½	Seat	14 ½	18	24	COM \$948 A \$958 B \$978 COL/C \$1,012 D \$1,056 E \$1,101 F \$1,170 G \$1,243 H \$1,322 I \$1,445 J \$1,592 L1 \$1,297 L2 \$1,396
		Dimensions	D	W	H										
Overall	18 ¼	18	27 ½												
Seat	14 ½	18	24												
<table border="1"> <thead> <tr> <th>Upholstery</th> <th>Shipping</th> </tr> </thead> <tbody> <tr> <td>COM Ydg ¾</td> <td>Ctn Wt 18</td> </tr> <tr> <td>COL Sq Ft 14</td> <td>Cu Ft 7</td> </tr> </tbody> </table>	Upholstery	Shipping	COM Ydg ¾	Ctn Wt 18	COL Sq Ft 14	Cu Ft 7									
Upholstery	Shipping														
COM Ydg ¾	Ctn Wt 18														
COL Sq Ft 14	Cu Ft 7														

Description	Model	Specifications	List Price Per Grade												
Bar Stool 	BU7518D · coordinates with bar height tables · metal foot rail · maple frame standard · walnut frame available, specify and add \$135 list	<table border="1"> <thead> <tr> <th>Dimensions</th> <th>D</th> <th>W</th> <th>H</th> </tr> </thead> <tbody> <tr> <td>Overall</td> <td>19 ½</td> <td>18</td> <td>33 ½</td> </tr> <tr> <td>Seat</td> <td>14 ½</td> <td>18</td> <td>30</td> </tr> </tbody> </table>	Dimensions	D	W	H	Overall	19 ½	18	33 ½	Seat	14 ½	18	30	COM \$948 A \$958 B \$978 COL/C \$1,012 D \$1,056 E \$1,101 F \$1,170 G \$1,243 H \$1,322 I \$1,445 J \$1,592 L1 \$1,297 L2 \$1,396
		Dimensions	D	W	H										
Overall	19 ½	18	33 ½												
Seat	14 ½	18	30												
<table border="1"> <thead> <tr> <th>Upholstery</th> <th>Shipping</th> </tr> </thead> <tbody> <tr> <td>COM Ydg ¾</td> <td>Ctn Wt 20</td> </tr> <tr> <td>COL Sq Ft 14</td> <td>Cu Ft 8</td> </tr> </tbody> </table>	Upholstery	Shipping	COM Ydg ¾	Ctn Wt 20	COL Sq Ft 14	Cu Ft 8									
Upholstery	Shipping														
COM Ydg ¾	Ctn Wt 20														
COL Sq Ft 14	Cu Ft 8														

To Order, Specify:

- 1 Model Number
- 2 Wood Species:
 - a.) Maple (M)
 - b.) Walnut (W) - upcharge applies
- 3 Finish
 - a.) Maple Finish
 - b.) Walnut Finish
- 4 Fabric Selection - vendor, pattern and color
 - a.) Seat and Lower Back
 - b.) Upper Back (only available on Dual Textile chairs)
- 5 Metal Foot Rail Color - Arctic Silver (ASL), Matte Black (MBK), Pewter (PEW) or Soft Nickel (SNK)
- 6 Optional Rubber Cushion Nylon Glides - no upcharge

Maple Finish Options:

- | | |
|----------------------------|-------------------------------|
| ALE Ale | CGR Graphite Coordinate |
| AUB Auburn | CHL High Line Coordinate |
| AUT Autumn | CKC Khaki Coordinate |
| BRL Barley | LGC Legacy |
| CBE Blonde Echo Coordinate | MCH Mocha |
| BBN Bourbon | NTO Night Owl |
| CBZ Brazilwood Coordinate | PRL Praline |
| BRG Brighton | SAF Saffron |
| BUT Butterscotch | SIE Sienna |
| CIN Cinnamon | CST Studio Teak Coordinate |
| CLA Classic | TOF Toffee |
| CCF Coffee Coordinate | TRF Truffle |
| CCR Cremello Coordinate | VEN Venetian |
| EAR Earthy | CVI Vintage Coordinate |
| ESP Espresso | CWH Walnut Heights Coordinate |
| FLX Flax | |

Walnut Finish Options: (upcharge applies)

- | | |
|---------------|-------------|
| AUB Auburn | SIE Sienna |
| ESP Espresso | TOF Toffee |
| MCH Mocha | TRF Truffle |
| NTO Night Owl | |

- 4 See a selection of graded in fabric manufacturers and patterns on pages 12-20 in JSI Seating price list. Contact Customer Service for additional fabric options.

Specifications

- Wood Species - Maple or Walnut.
- Seats are upholstered with high density polyurethane foam.
- Backs are tapered and upholstered with polyurethane foam.
- Mortise and tenon construction with corner blocks, glue and screws.
- Standard with rubber cushion metal glides.

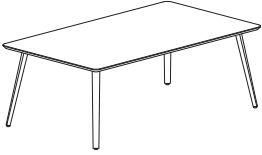
Description	D	W	H	CTN WT	CU FT	① Model	Flat Cut or HPL Laminate Top	Double Cut Top	Solid Surface Top
30" h Rectangular Table with Wood Legs 	48	90	30	210	38	BU4890-30TTWL	\$2,460	\$2,510	\$6,310
	48	84	30	200	35	BU4884-30TTWL	\$2,411	\$2,461	\$6,261
	48	72	30	180	30	BU4872-30TTWL	\$2,230	\$2,280	\$4,296
	42	90	30	191	33	BU4290-30TTWL	\$2,382	\$2,432	\$6,232
	42	84	30	183	31	BU4284-30TTWL	\$2,249	\$2,299	\$6,068
	42	72	30	165	27	BU4272-30TTWL	\$2,106	\$2,156	\$4,152
	36	72	30	151	23	BU3672-30TTWL	\$2,019	\$2,069	\$4,065

- ships KD
- optional accessory hooks (four hooks) available, specify and add \$140 list, see page 13
- EC26 worksurface power available, specify "to accommodate worksurface power" on your purchase order; one EC26 unit must be ordered separately, see page 33
- EC27 under surface power available, see page 33
- knife edge
- maple legs/apron standard
- walnut legs/apron available, specify and add \$400 list

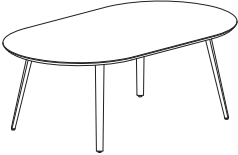
30" h Racetrack Table with Wood Legs 	48	90	30	193	38	BU4890-30RTWL	\$2,434	\$2,484	\$6,284
	48	84	30	183	35	BU4884-30RTWL	\$2,383	\$2,433	\$6,233
	48	72	30	163	30	BU4872-30RTWL	\$2,201	\$2,251	\$4,266
	42	90	30	178	33	BU4290-30RTWL	\$2,359	\$2,409	\$6,209
	42	84	30	170	31	BU4284-30RTWL	\$2,225	\$2,275	\$6,043
	42	72	30	152	27	BU4272-30RTWL	\$2,080	\$2,130	\$4,126
	42	60	30	135	23	BU4260-30RTWL	\$1,966	\$2,016	\$4,012

- ships KD
- optional accessory hooks (four hooks) available, specify and add \$140 list, see page 13
- EC26 worksurface power available, specify "to accommodate worksurface power" on your purchase order; one EC26 unit must be ordered separately, see page 33
- EC27 under surface power available, see page 33
- knife edge
- maple legs/apron standard
- walnut legs/apron available, specify and add \$400 list

Description	D	W	H	CTN WT	CU FT	Model	Flat Cut or HPL Laminate Top	Double Cut Top	Solid Surface Top
30" Square Table with Wood Legs	60	60	30	185	32	BU6060-30TTWL	\$2,308	\$2,358	\$4,404
	48	48	30	141	21	BU4848-30TTWL	\$1,958	\$2,008	\$3,569
	42	42	30	122	16	BU4242-30TTWL	\$1,873	\$1,923	\$3,484



- ships KD
- optional accessory hooks (four hooks) available, specify and add \$140 list, see page 13
- EC26 worksurface power available, specify "to accommodate worksurface power" on your purchase order; one EC26 unit must be ordered separately, see page 33
- EC27 under surface power available, see page 33
- knife edge
- maple legs/apron standard
- walnut legs/apron available, specify and add \$400 list

30" Round Table with Wood Legs	60	60	30	159	32	BU60-30RDWL	\$2,265	\$2,315	\$4,362
--------------------------------	----	----	----	-----	----	-------------	---------	---------	---------



- ships KD
- optional accessory hooks (four hooks) available, specify and add \$140 list, see page 13
- EC26 worksurface power available, specify "to accommodate worksurface power" on your purchase order; one EC26 unit must be ordered separately, see page 33
- EC27 under surface power available, see page 33
- knife edge
- maple legs/apron standard
- walnut legs/apron available, specify and add \$400 list

To Order, Specify:

- Model Number
- Top Material:
 - Veneer
 - Wood Species - Cherry (CH1), Maple (MA1), Walnut (WA1) or Double Cut (DC1)
 - Finish Color
 - Laminate
 - Laminate Color
 - Solid Surface - Pebble Pearl (PEB), Pure White (PUR) or Saddlebow Gray (SDB)
- Legs/Apron Species:
 - Maple (M)
 - Finish Color - cherry, maple, walnut or paint color on maple legs/apron
 - Walnut (W) - upcharge applies
 - Finish Color - walnut finishes only on walnut legs/apron
- Optional Accessory Hooks - four hooks; specify and add \$140 list, (see page 13)
- Optional Power Units:
 - Work Surface Power; specify with EC26 cut-out. EC26 must be ordered separately, (see page 11)
 - Under Surface Power; mounts under top. EC27 must be ordered separately, (see page 11)

2a Veneer Top Finish Options:

Cherry		Maple		Walnut	
AUT	Autumn	ALE	Ale	AUB	Auburn
BRL	Barley	BUT	Butterscotch	ESP	Espresso
BBN	Bourbon	CIN	Cinnamon	MCH	Mocha
BRG	Brighton	FLX	Flax	NTO	Night Owl
CLA	Classic	VEN	Venetian	SIE	Sienna
EAR	Earthy			TOF	Toffee
LGC	Legacy			TRF	Truffle
PRL	Praline				
SAF	Saffron				

2b Laminate Top Options:

Veneer Grain Pattern Laminates					
AUB	Auburn	CLA	Classic	SHE	Shea
AUT	Autumn	GRH	Graphite	SIE	Sienna
BRL	Barley	HGL	Highline	STU	Studio Teak
BLO	Blonde Echo	LGC	Legacy	TOF	Toffee
BBN	Bourbon	MCH	Mocha	TRF	Truffle
BZW	Brazilwood	NTO	Night Owl	VEN	Venetian
BRG	Brighton	PRL	Praline	VIN	Vintage
CIN	Cinnamon	SAF	Saffron	WLH	Walnut Heights

Solid Laminates

ALB	Alabaster	SHD	Shadow
BBL	Bridal Blanco	SLG	Slate Grey
DWH	Designer White	TAU	Taupe
DOV	Dove Grey		

2c Solid Surface Top Options:

PEB	Pebble Pearl
PUR	Pure White
SDB	Saddlebow Gray

3a Maple Legs/Apron Finish Options:

ALE	Ale	CGR	Graphite Coordinate
AUB	Auburn	CHL	High Line Coordinate
AUT	Autumn	CKC	Khaki Coordinate
BRL	Barley	LGC	Legacy
CBE	Blonde Echo Coordinate	MCH	Mocha
BBN	Bourbon	NTO	Night Owl
CBZ	Brazilwood Coordinate	PRL	Praline
BRG	Brighton	SAF	Saffron
BUT	Butterscotch	SIE	Sienna
CIN	Cinnamon	CST	Studio Teak Coordinate
CLA	Classic	TOF	Toffee
CCF	Coffee Coordinate	TRF	Truffle
CCR	Cremello Coordinate	VEN	Venetian
EAR	Earthy	CVI	Vintage Coordinate
ESP	Espresso	CWH	Walnut Heights Coordinate
FLX	Flax		

Paint Colors (Maple only)

BKD	Backdrop	GRV	Greek Villa
BFX	Black Fox	NET	Network Gray
BWH	Bright White	NWH	Nonchalant White
CGP	Cargo Pants	STM	Storm
CHT	Chatroom	TRC	Tricorn Black
FRR	French Roast		

3b Walnut Legs/Apron Finish Options:

AUB	Auburn
ESP	Espresso
MCH	Mocha
NTO	Night Owl
SIE	Sienna
TOF	Toffee
TRF	Truffle

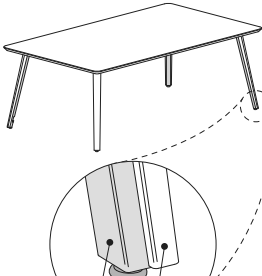
Description	D	W	H	CTN WT	CU FT	① Model	Flat Cut or	Double Cut	Solid Surface
							HPL Laminate Top	Top	Top
30" h Rectangular Table with Wood/Metal Legs 	48	90	30	222	38	BU4890-30TTML	\$4,126	\$4,176	\$7,977
	48	84	30	212	35	BU4884-30TTML	\$4,040	\$4,090	\$7,890
	48	72	30	192	30	BU4872-30TTML	\$3,825	\$3,875	\$5,891
	42	90	30	203	33	BU4290-30TTML	\$3,997	\$4,047	\$7,847
	42	84	30	195	31	BU4284-30TTML	\$3,829	\$3,879	\$7,648
	42	72	30	177	27	BU4272-30TTML	\$3,652	\$3,702	\$5,698
	36	72	30	162	23	BU3672-30TTML	\$3,536	\$3,586	\$5,582

- ships KD
- metal legs with removable wood surround to access and manage wires
- optional accessory hooks (four hooks) available, specify and add \$140 list, see page 13
- EC26 worksurface power available, specify "to accommodate worksurface power" on your purchase order; one EC26 unit must be ordered separately, see page 33
- EC27 under surface power available, see page 33
- knife edge
- maple legs/apron standard
- walnut legs/apron available, specify and add \$275 list

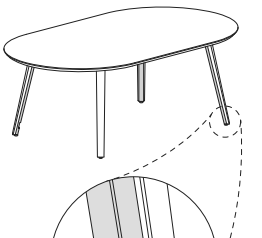
30" h Racetrack Table with Wood/Metal Legs 	48	90	30	205	38	BU4890-30RTML	\$3,974	\$4,024	\$7,825
	48	84	30	195	35	BU4884-30RTML	\$3,881	\$3,931	\$7,731
	48	72	30	175	30	BU4872-30RTML	\$3,649	\$3,699	\$5,715
	42	90	30	190	33	BU4290-30RTML	\$3,872	\$3,922	\$7,722
	42	84	30	182	31	BU4284-30RTML	\$3,699	\$3,749	\$7,518
	42	72	30	164	27	BU4272-30RTML	\$3,504	\$3,554	\$5,550
	42	60	30	147	23	BU4260-30RTML	\$3,329	\$3,379	\$5,375

- ships KD
- metal legs with removable wood surround to access and manage wires
- optional accessory hooks (four hooks) available, specify and add \$140 list, see page 13
- EC26 worksurface power available, specify "to accommodate worksurface power" on your purchase order; one EC26 unit must be ordered separately, see page 33
- EC27 under surface power available, see page 33
- knife edge
- maple legs/apron standard
- walnut legs/apron available, specify and add \$275 list

BOURNE

Description	D	W	H	CTN WT	CU FT	Model	Flat Cut or HPL Laminate Top	Double Cut Top	Solid Surface Top
30" Square Table with Wood/ Metal Legs	60	60	30	197	32	BU6060-30TTML	\$3,888	\$3,938	\$5,984
	48	48	30	153	21	BU4848-30TTML	\$3,445	\$3,495	\$5,057
	42	42	30	134	16	BU4242-30TTML	\$3,252	\$3,302	\$4,864

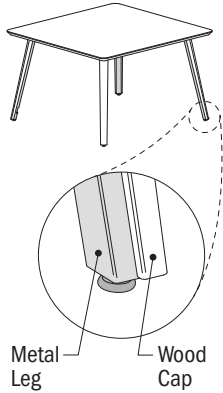

- ships KD
- metal legs with removable wood surround to access and manage wires
- optional accessory hooks (four hooks) available, specify and add \$140 list, see page 13
- EC26 worksurface power available, specify "to accommodate worksurface power" on your purchase order; one EC26 unit must be ordered separately, see page 33
- EC27 under surface power available, see page 33
- knife edge
- maple legs/apron standard
- walnut legs/apron available, specify and add \$275 list

30" Round Table with Wood/ Metal Legs	60	60	30	170	32	BU60-30RDML	\$3,645	\$3,695	\$5,732
--	----	----	----	-----	----	-------------	---------	---------	---------

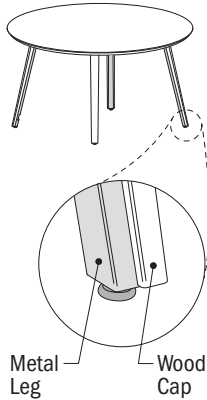

- ships KD
- metal legs with removable wood surround to access and manage wires
- optional accessory hooks (four hooks) available, specify and add \$140 list, see page 13
- EC26 worksurface power available, specify "to accommodate worksurface power" on your purchase order; one EC26 unit must be ordered separately, see page 33
- EC27 under surface power available, see page 33
- knife edge
- maple legs/apron standard
- walnut legs/apron available, specify and add \$275 list

To Order, Specify:

- Model Number
- Top Material:
 - Veneer
 - Wood Species - Cherry (CH1), Maple (MA1), Walnut (WA1) or Double Cut (DC1)
 - Finish Color
 - Laminate
 - Laminate Color
 - Solid Surface - Pebble Pearl (PEB), Pure White (PUR) or Saddlebow Gray (SDB)
 - Legs/Apron Species:
 - Maple (M)
 - Finish Color - cherry, maple, walnut or paint color on maple legs/apron
 - Walnut (W) - upcharge applies
 - Finish Color - walnut finishes only on walnut legs/apron
 - Metal Leg Color - Arctic Silver (ASL), Matte Black (MBK), Pewter (PEW) or Soft Nickel (SNK)
 - Optional Accessory Hooks - four hooks; specify and add \$140 list, (see page 13)
 - Optional Power Units:
 - Work Surface Power; specify with EC26 cut-out. EC26 must be ordered separately, (see page 11)
 - Under Surface Power; mounts under top. EC27 must be ordered separately, (see page 11)

23 Veneer Top Finish Options:

Cherry		Maple		Walnut	
AUT	Autumn	ALE	Ale	AUB	Auburn
BRL	Barley	BUT	Butterscotch	ESP	Espresso
BBN	Bourbon	CIN	Cinnamon	MCH	Mocha
BRG	Brighton	FLX	Flax	NTO	Night Owl
CLA	Classic	VEN	Venetian	SIE	Sienna
EAR	Earthy			TOF	Toffee
LGC	Legacy			TRF	Truffle
PRL	Praline				
SAF	Saffron				

24 Laminate Top Options:

Veneer Grain Pattern Laminates					
AUB	Auburn	CLA	Classic	SHE	Shea
AUT	Autumn	GRH	Graphite	SIE	Sienna
BRL	Barley	HGL	Highline	STU	Studio Teak
BLO	Blonde Echo	LGC	Legacy	TOF	Toffee
BBN	Bourbon	MCH	Mocha	TRF	Truffle
BZW	Brazilwood	NTO	Night Owl	VEN	Venetian
BRG	Brighton	PRL	Praline	VIN	Vintage
CIN	Cinnamon	SAF	Saffron	WLH	Walnut Heights

Solid Laminates

ALB	Alabaster	SHD	Shadow
BBL	Bridal Blanco	SLG	Slate Grey
DWH	Designer White	TAU	Taupe
DOV	Dove Grey		

25 Solid Surface Top Options:

PEB	Pebble Pearl
PUR	Pure White
SDB	Saddlebow Gray

33 Maple Legs/Apron Finish Options:

ALE	Ale	CGR	Graphite Coordinate
AUB	Auburn	CHL	High Line Coordinate
AUT	Autumn	CKC	Khaki Coordinate
BRL	Barley	LGC	Legacy
CBE	Blonde Echo Coordinate	MCH	Mocha
BBN	Bourbon	NTO	Night Owl
CBZ	Brazilwood Coordinate	PRL	Praline
BRG	Brighton	SAF	Saffron
BUT	Butterscotch	SIE	Sienna
CIN	Cinnamon	CST	Studio Teak Coordinate
CLA	Classic	TOF	Toffee
CCF	Coffee Coordinate	TRF	Truffle
CCR	Cremello Coordinate	VEN	Venetian
EAR	Earthy	CVI	Vintage Coordinate
ESP	Espresso	CWH	Walnut Heights Coordinate
FLX	Flax		

Paint Colors (Maple only)

BKD	Backdrop	GRV	Greek Villa
BFX	Black Fox	NET	Network Gray
BWH	Bright White	NWH	Nonchalant White
CGP	Cargo Pants	STM	Storm
CHT	Chatroom	TRC	Tricorn Black
FRR	French Roast		

34 Walnut Legs/Apron Finish Options:

AUB	Auburn
ESP	Espresso
MCH	Mocha
NTO	Night Owl
SIE	Sienna
TOF	Toffee
TRF	Truffle

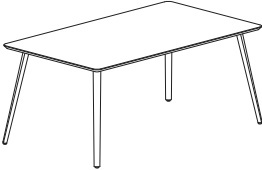
Description	D	W	H	CTN WT	CU FT	① Model	Flat Cut or HPL Laminate Top	Double Cut Top	Solid Surface Top
36" h Rectangular Table with Wood Legs 	48	90	36	202	38	BU4890-36TTWL	\$2,585	\$2,635	\$6,435
	48	84	36	192	35	BU4884-36TTWL	\$2,536	\$2,586	\$6,386
	48	72	36	172	30	BU4872-36TTWL	\$2,355	\$2,405	\$4,421
	42	90	36	184	33	BU4290-36TTWL	\$2,507	\$2,557	\$6,357
	42	84	36	175	31	BU4284-36TTWL	\$2,374	\$2,424	\$6,193
	42	72	36	158	27	BU4272-36TTWL	\$2,231	\$2,281	\$4,277
	36	72	36	143	23	BU3672-36TTWL	\$2,144	\$2,194	\$4,190

- ships KD
- optional accessory hooks (four hooks) available, specify and add \$140 list, see page 13
- EC26 worksurface power available, specify "to accommodate worksurface power" on your purchase order; one EC26 unit must be ordered separately, see page 33
- EC27 under surface power available, see page 33
- knife edge
- maple legs/apron standard
- walnut legs/apron available, specify and add \$475 list

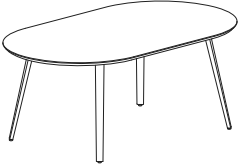
36" h Racetrack Table with Wood Legs 	48	90	36	185	38	BU4890-36RTWL	\$2,559	\$2,609	\$6,409
	48	84	36	175	35	BU4884-36RTWL	\$2,508	\$2,558	\$6,358
	48	72	36	155	30	BU4872-36RTWL	\$2,326	\$2,376	\$4,391
	42	90	36	171	33	BU4290-36RTWL	\$2,484	\$2,534	\$6,334
	42	84	36	162	31	BU4284-36RTWL	\$2,350	\$2,400	\$6,168
	42	72	36	145	27	BU4272-36RTWL	\$2,205	\$2,255	\$4,251
	42	60	36	127	23	BU4260-36RTWL	\$2,091	\$2,141	\$4,137

- ships KD
- optional accessory hooks (four hooks) available, specify and add \$140 list, see page 13
- EC26 worksurface power available, specify "to accommodate worksurface power" on your purchase order; one EC26 unit must be ordered separately, see page 33
- EC27 under surface power available, see page 33
- knife edge
- maple legs/apron standard
- walnut legs/apron available, specify and add \$475 list

Description	D	W	H	CTN WT	CU FT	Model	Flat Cut or HPL Laminate Top	Double Cut Top	Solid Surface Top
36" Square Table with Wood Legs	60	60	36	177	32	BU6060-36TTWL	\$2,433	\$2,483	\$4,529
	48	48	36	133	21	BU4848-36TTWL	\$2,083	\$2,133	\$3,694
	42	42	36	114	16	BU4242-36TTWL	\$1,998	\$2,048	\$3,609



- ships KD
- optional accessory hooks (four hooks) available, specify and add \$140 list, see page 13
- EC26 worksurface power available, specify "to accommodate worksurface power" on your purchase order; one EC26 unit must be ordered separately, see page 33
- EC27 under surface power available, see page 33
- knife edge
- maple legs/apron standard
- walnut legs/apron available, specify and add \$475 list

36" Round Table with Wood Legs	60	60	36	151	32	BU60-36RDWL	\$2,390	\$2,440	\$4,487
--------------------------------	----	----	----	-----	----	-------------	---------	---------	---------



- ships KD
- optional accessory hooks (four hooks) available, specify and add \$140 list, see page 13
- EC26 worksurface power available, specify "to accommodate worksurface power" on your purchase order; one EC26 unit must be ordered separately, see page 33
- EC27 under surface power available, see page 33
- knife edge
- maple legs/apron standard
- walnut legs/apron available, specify and add \$475 list

To Order, Specify:

- Model Number
- Top Material:
 - Veneer
 - Wood Species - Cherry (CH1), Maple (MA1), Walnut (WA1) or Double Cut (DC1)
 - Finish Color
 - Laminate
 - Laminate Color
 - Solid Surface - Pebble Pearl (PEB), Pure White (PUR) or Saddlebow Gray (SDB)
- Legs/Apron Species:
 - Maple (M)
 - Finish Color - cherry, maple, walnut or paint color on maple legs/apron
 - Walnut (W) - upcharge applies
 - Finish Color - walnut finishes only on walnut legs/apron
- Optional Accessory Hooks - four hooks; specify and add \$140 list, (see page 13)
- Optional Power Units:
 - Work Surface Power; specify with EC26 cut-out. EC26 must be ordered separately, (see page 11)
 - Under Surface Power; mounts under top. EC27 must be ordered separately, (see page 11)

23 Veneer Top Finish Options:

Cherry		Maple		Walnut	
AUT	Autumn	ALE	Ale	AUB	Auburn
BRL	Barley	BUT	Butterscotch	ESP	Espresso
BBN	Bourbon	CIN	Cinnamon	MCH	Mocha
BRG	Brighton	FLX	Flax	NTO	Night Owl
CLA	Classic	VEN	Venetian	SIE	Sienna
EAR	Earthy			TOF	Toffee
LGC	Legacy			TRF	Truffle
PRL	Praline				
SAF	Saffron				

24 Laminate Top Options:

Veneer Grain Pattern Laminates					
AUB	Auburn	CLA	Classic	SHE	Shea
AUT	Autumn	GRH	Graphite	SIE	Sienna
BRL	Barley	HGL	Highline	STU	Studio Teak
BLO	Blonde Echo	LGC	Legacy	TOF	Toffee
BBN	Bourbon	MCH	Mocha	TRF	Truffle
BZW	Brazilwood	NTO	Night Owl	VEN	Venetian
BRG	Brighton	PRL	Praline	VIN	Vintage
CIN	Cinnamon	SAF	Saffron	WLH	Walnut Heights

Solid Laminates

ALB	Alabaster	SHD	Shadow
BBL	Bridal Blanco	SLG	Slate Grey
DWH	Designer White	TAU	Taupe
DOV	Dove Grey		

25 Solid Surface Top Options:

PEB	Pebble Pearl
PUR	Pure White
SDB	Saddlebow Gray

33 Maple Legs/Apron Finish Options:

ALE	Ale	CGR	Graphite Coordinate
AUB	Auburn	CHL	High Line Coordinate
AUT	Autumn	CKC	Khaki Coordinate
BRL	Barley	LGC	Legacy
CBE	Blonde Echo Coordinate	MCH	Mocha
BBN	Bourbon	NTO	Night Owl
CBZ	Brazilwood Coordinate	PRL	Praline
BRG	Brighton	SAF	Saffron
BUT	Butterscotch	SIE	Sienna
CIN	Cinnamon	CST	Studio Teak Coordinate
CLA	Classic	TOF	Toffee
CCF	Coffee Coordinate	TRF	Truffle
CCR	Cremello Coordinate	VEN	Venetian
EAR	Earthy	CVI	Vintage Coordinate
ESP	Espresso	CWH	Walnut Heights Coordinate
FLX	Flax		

Paint Colors (Maple only)

BKD	Backdrop	GRV	Greek Villa
BFX	Black Fox	NET	Network Gray
BWH	Bright White	NWH	Nonchalant White
CGP	Cargo Pants	STM	Storm
CHT	Chatroom	TRC	Tricorn Black
FRR	French Roast		

34 Walnut Legs/Apron Finish Options:

AUB	Auburn
ESP	Espresso
MCH	Mocha
NTO	Night Owl
SIE	Sienna
TOF	Toffee
TRF	Truffle

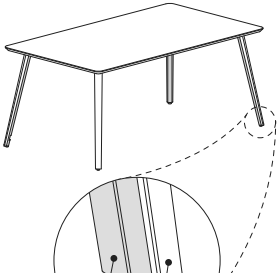
Description	D	W	H	CTN WT	CU FT	Model	Flat Cut or HPL Laminate Top	Double Cut Top	Solid Surface Top
36" h Rectangular Table with Wood/Metal Legs 	48	90	36	230	38	BU4890-36TTML	\$4,276	\$4,326	\$8,127
	48	84	36	220	35	BU4884-36TTML	\$4,190	\$4,240	\$8,040
	48	72	36	200	30	BU4872-36TTML	\$3,975	\$4,025	\$6,041
	42	90	36	212	33	BU4290-36TTML	\$4,147	\$4,197	\$7,997
	42	84	36	203	31	BU4284-36TTML	\$3,979	\$4,029	\$7,798
	42	72	36	186	27	BU4272-36TTML	\$3,802	\$3,852	\$5,848
	36	72	36	171	23	BU3672-36TTML	\$3,686	\$3,736	\$5,732

- ships KD
- metal legs with removable wood surround to access and manage wires
- optional accessory hooks (four hooks) available, specify and add \$140 list, see page 13
- EC26 worksurface power available, specify "to accommodate worksurface power" on your purchase order; one EC26 unit must be ordered separately, see page 33
- EC27 under surface power available, see page 33
- knife edge
- maple legs/apron standard
- walnut legs/apron available, specify and add \$350 list

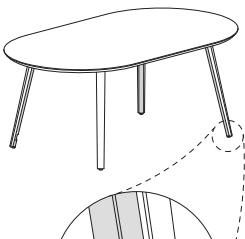
36" h Racetrack Table with Wood/Metal Legs 	48	90	36	213	38	BU4890-36RTML	\$4,124	\$4,174	\$7,975
	48	84	36	203	35	BU4884-36RTML	\$4,031	\$4,081	\$7,881
	48	72	36	183	30	BU4872-36RTML	\$3,799	\$3,849	\$5,865
	42	90	36	199	33	BU4290-36RTML	\$4,022	\$4,072	\$7,872
	42	84	36	190	31	BU4284-36RTML	\$3,849	\$3,899	\$7,668
	42	72	36	173	27	BU4272-36RTML	\$3,654	\$3,704	\$5,700
	42	60	36	155	23	BU4260-36RTML	\$3,479	\$3,529	\$5,525

- ships KD
- metal legs with removable wood surround to access and manage wires
- optional accessory hooks (four hooks) available, specify and add \$140 list, see page 13
- EC26 worksurface power available, specify "to accommodate worksurface power" on your purchase order; one EC26 unit must be ordered separately, see page 33
- EC27 under surface power available, see page 33
- knife edge
- maple legs/apron standard
- walnut legs/apron available, specify and add \$350 list

Description	D	W	H	CTN WT	CU FT	Model	Flat Cut or HPL Laminate Top	Double Cut Top	Solid Surface Top
36" Square Table with Wood/Metal Legs	60	60	36	205	32	BU6060-36TTML	\$4,038	\$4,088	\$6,134
	48	48	36	161	21	BU4848-36TTML	\$3,595	\$3,645	\$5,207
	42	42	36	142	16	BU4242-36TTML	\$3,402	\$3,452	\$5,014

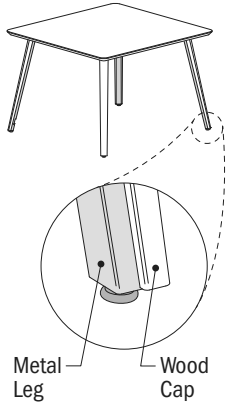

- ships KD
- metal legs with removable wood surround to access and manage wires
- optional accessory hooks (four hooks) available, specify and add \$140 list, see page 13
- EC26 worksurface power available, specify "to accommodate worksurface power" on your purchase order; one EC26 unit must be ordered separately, see page 33
- EC27 under surface power available, see page 33
- knife edge
- maple legs/apron standard
- walnut legs/apron available, specify and add \$350 list

36" Round Table with Wood/Metal Legs	60	60	36	179	32	BU60-36RDML	\$3,795	\$3,845	\$5,882
--------------------------------------	----	----	----	-----	----	-------------	---------	---------	---------

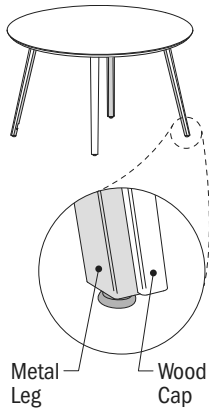

- ships KD
- metal legs with removable wood surround to access and manage wires
- optional accessory hooks (four hooks) available, specify and add \$140 list, see page 13
- EC26 worksurface power available, specify "to accommodate worksurface power" on your purchase order; one EC26 unit must be ordered separately, see page 33
- EC27 under surface power available, see page 33
- knife edge
- maple legs/apron standard
- walnut legs/apron available, specify and add \$350 list

To Order, Specify:

- Model Number
- Top Material:
 - Veneer
 - Wood Species - Cherry (CH1), Maple (MA1), Walnut (WA1) or Double Cut (DC1)
 - Finish Color
 - Laminate
 - Laminate Color
 - Solid Surface - Pebble Pearl (PEB), Pure White (PUR) or Saddlebow Gray (SDB)
- Legs/Apron Species:
 - Maple (M)
 - Finish Color - cherry, maple, walnut or paint color on maple legs/apron
 - Walnut (W) - upcharge applies
 - Finish Color - walnut finishes only on walnut legs/apron
- Metal Leg Color - Arctic Silver (ASL), Matte Black (MBK), Pewter (PEW) or Soft Nickel (SNK)
- Optional Accessory Hooks - four hooks; specify and add \$140 list, (see page 13)
- Optional Power Units:
 - Work Surface Power; specify with EC26 cut-out. EC26 must be ordered separately, (see page 11)
 - Under Surface Power; mounts under top. EC27 must be ordered separately, (see page 11)

23 Veneer Top Finish Options:

Cherry		Maple		Walnut	
AUT	Autumn	ALE	Ale	AUB	Auburn
BRL	Barley	BUT	Butterscotch	ESP	Espresso
BBN	Bourbon	CIN	Cinnamon	MCH	Mocha
BRG	Brighton	FLX	Flax	NTO	Night Owl
CLA	Classic	VEN	Venetian	SIE	Sienna
EAR	Earthy			TOF	Toffee
LGC	Legacy			TRF	Truffle
PRL	Praline				
SAF	Saffron				

24 Laminate Top Options:

Veneer Grain Pattern Laminates					
AUB	Auburn	CLA	Classic	SHE	Shea
AUT	Autumn	GRH	Graphite	SIE	Sienna
BRL	Barley	HGL	Highline	STU	Studio Teak
BLO	Blonde Echo	LGC	Legacy	TOF	Toffee
BBN	Bourbon	MCH	Mocha	TRF	Truffle
BZW	Brazilwood	NTO	Night Owl	VEN	Venetian
BRG	Brighton	PRL	Praline	VIN	Vintage
CIN	Cinnamon	SAF	Saffron	WLH	Walnut Heights

Solid Laminates

ALB	Alabaster	SHD	Shadow
BBL	Bridal Blanco	SLG	Slate Grey
DWH	Designer White	TAU	Taupe
DOV	Dove Grey		

25 Solid Surface Top Options:

PEB	Pebble Pearl
PUR	Pure White
SDB	Saddlebow Gray

33 Maple Legs/Apron Finish Options:

ALE	Ale	CGR	Graphite Coordinate
AUB	Auburn	CHL	High Line Coordinate
AUT	Autumn	CKC	Khaki Coordinate
BRL	Barley	LGC	Legacy
CBE	Blonde Echo Coordinate	MCH	Mocha
BBN	Bourbon	NTO	Night Owl
CBZ	Brazilwood Coordinate	PRL	Praline
BRG	Brighton	SAF	Saffron
BUT	Butterscotch	SIE	Sienna
CIN	Cinnamon	CST	Studio Teak Coordinate
CLA	Classic	TOF	Toffee
CCF	Coffee Coordinate	TRF	Truffle
CCR	Cremello Coordinate	VEN	Venetian
EAR	Earthy	CVI	Vintage Coordinate
ESP	Espresso	CWH	Walnut Heights Coordinate
FLX	Flax		

Paint Colors (Maple only)

BKD	Backdrop	GRV	Greek Villa
BFX	Black Fox	NET	Network Gray
BWH	Bright White	NWH	Nonchalant White
CGP	Cargo Pants	STM	Storm
CHT	Chatroom	TRC	Tricorn Black
FRR	French Roast		

34 Walnut Legs/Apron Finish Options:

AUB	Auburn
ESP	Espresso
MCH	Mocha
NTO	Night Owl
SIE	Sienna
TOF	Toffee
TRF	Truffle

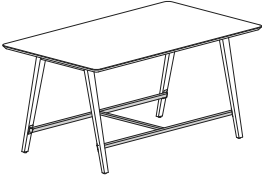
Description	D	W	H	CTN WT	CU FT	① Model	Flat Cut or HPL Laminate Top	Double Cut Top	Solid Surface Top
40" h Rectangular Table with Wood Legs 	48	90	40	219	38	BU4890-40TTWLH	\$3,439	\$3,489	\$7,290
	48	84	40	209	35	BU4884-40TTWLH	\$3,345	\$3,395	\$7,195
	48	72	40	189	30	BU4872-40TTWLH	\$3,141	\$3,191	\$5,207
	42	90	40	200	33	BU4290-40TTWLH	\$3,369	\$3,419	\$7,219
	42	84	40	192	31	BU4284-40TTWLH	\$3,200	\$3,250	\$7,019
	42	72	40	174	27	BU4272-40TTWLH	\$3,050	\$3,100	\$5,095

- ships KD
- optional accessory hooks (four hooks) available, specify and add \$140 list, see page 13
- EC26 worksurface power available, specify "to accommodate worksurface power" on your purchase order; one EC26 unit must be ordered separately, see page 33
- EC27 under surface power available, see page 33
- metal foot rail
- knife edge
- maple legs/apron standard
- walnut legs/apron available, specify and add \$550 list

Description	D	W	H	CTN WT	CU FT	Model	Flat Cut or HPL Laminate Top	Double Cut Top	Solid Surface Top
40" h Rectangular Table with Wood/Metal Legs	48	90	40	247	38	BU4890-40TTMLH	\$4,934	\$4,984	\$8,784
	48	84	40	237	35	BU4884-40TTMLH	\$4,814	\$4,864	\$8,665
	48	72	40	217	30	BU4872-40TTMLH	\$4,542	\$4,592	\$6,608
	42	90	40	228	33	BU4290-40TTMLH	\$4,863	\$4,913	\$8,713
	42	84	40	220	31	BU4284-40TTMLH	\$4,645	\$4,695	\$8,464
	42	72	40	202	27	BU4272-40TTMLH	\$4,434	\$4,484	\$6,480

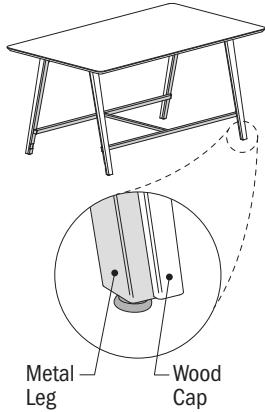

- ships KD
- metal legs with removable wood surround to access and manage wires
- optional accessory hooks (four hooks) available, specify and add \$140 list, see page 13
- EC26 worksurface power available, specify "to accommodate worksurface power" on your purchase order; one EC26 unit must be ordered separately, see page 33
- EC27 under surface power available, see page 33
- metal foot rail, color will be same as the metal leg
- knife edge
- maple legs/apron standard
- walnut legs/apron available, specify and add \$425 list

To Order, Specify:

- Model Number
- Top Material:
 - Veneer
 - Wood Species - Cherry (CH1), Maple (MA1), Walnut (WA1) or Double Cut (DC1)
 - Finish Color
 - Laminate
 - Laminate Color
 - Solid Surface - Pebble Pearl (PEB), Pure White (PUR) or Saddlebow Gray (SDB)
- Legs/Apron Species:
 - Maple (M)
 - Finish Color - cherry, maple, walnut or paint color on maple legs/apron
 - Walnut (W) - upcharge applies
 - Finish Color - walnut finishes only on walnut legs/apron
- Metal Leg Color - Arctic Silver (ASL), Matte Black (MBK), Pewter (PEW) or Soft Nickel (SNK)
- Optional Accessory Hooks - four hooks; specify and add \$140 list, (see page 13)
- Optional Power Units:
 - Work Surface Power; specify with EC26 cut-out. EC26 must be ordered separately, (see page 11)
 - Under Surface Power; mounts under top. EC27 must be ordered separately, (see page 11)

2a Veneer Top Finish Options:

<u>Cherry</u>		<u>Maple</u>		<u>Walnut</u>	
AUT	Autumn	ALE	Ale	AUB	Auburn
BRL	Barley	BUT	Butterscotch	ESP	Espresso
BBN	Bourbon	CIN	Cinnamon	MCH	Mocha
BRG	Brighton	FLX	Flax	NTO	Night Owl
CLA	Classic	VEN	Venetian	SIE	Sienna
EAR	Earthy			TOF	Toffee
LGC	Legacy			TRF	Truffle
PRL	Praline				
SAF	Saffron				
<u>Double Cut</u>					
COF	Coffee				
CRM	Cremello				
GRH	Graphite				
KHK	Khaki				
STU	Studio Teak				

2b Laminate Top Options:

<u>Veneer Grain Pattern Laminates</u>					
AUB	Auburn	CLA	Classic	SHE	Shea
AUT	Autumn	GRH	Graphite	SIE	Sienna
BRL	Barley	HGL	Highline	STU	Studio Teak
BLO	Blonde Echo	LGC	Legacy	TOF	Toffee
BBN	Bourbon	MCH	Mocha	TRF	Truffle
BZW	Brazilwood	NTO	Night Owl	VEN	Venetian
BRG	Brighton	PRL	Praline	VIN	Vintage
CIN	Cinnamon	SAF	Saffron	WLH	Walnut Heights

Solid Laminates

ALB	Alabaster	SHD	Shadow
BBL	Bridal Blanco	SLG	Slate Grey
DWH	Designer White	TAU	Taupe
DOV	Dove Grey		

2c Solid Surface Top Options:

PEB	Pebble Pearl
PUR	Pure White
SDB	Saddlebow Gray

3a Maple Legs/Apron Finish Options:

ALE	Ale	CGR	Graphite Coordinate
AUB	Auburn	CHL	High Line Coordinate
AUT	Autumn	CKC	Khaki Coordinate
BRL	Barley	LGC	Legacy
CBE	Blonde Echo Coordinate	MCH	Mocha
BBN	Bourbon	NTO	Night Owl
CBZ	Brazilwood Coordinate	PRL	Praline
BRG	Brighton	SAF	Saffron
BUT	Butterscotch	SIE	Sienna
CIN	Cinnamon	CST	Studio Teak Coordinate
CLA	Classic	TOF	Toffee
CCF	Coffee Coordinate	TRF	Truffle
CCR	Cremello Coordinate	VEN	Venetian
EAR	Earthy	CVI	Vintage Coordinate
ESP	Espresso	CWH	Walnut Heights Coordinate
FLX	Flax		

Paint Colors (Maple only)

BKD	Backdrop	GRV	Greek Villa
BFX	Black Fox	NET	Network Gray
BWH	Bright White	NWH	Nonchalant White
CGP	Cargo Pants	STM	Storm
CHT	Chatroom	TRC	Tricorn Black
FRR	French Roast		

3b Walnut Legs/Apron Finish Options:

AUB	Auburn
ESP	Espresso
MCH	Mocha
NTO	Night Owl
SIE	Sienna
TOF	Toffee
TRF	Truffle

Description	D	W	H	CTN WT	CU FT	① Model	Flat Cut or HPL Laminate Top	Double Cut Top	Solid Surface Top
Rectangular Coffee Table	24	48	17	39	11	BU2448-17TTWL	\$1,208	\$1,258	\$1,939



- ships KD
- knife edge
- maple legs/apron standard
- walnut legs/apron available, specify and add \$125 list

Square Coffee Table	42	42	17	54	16	BU4242-17TTWL	\$1,259	\$1,309	\$2,826
----------------------------	----	----	----	----	----	----------------------	----------------	----------------	----------------

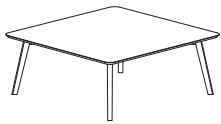

- ships KD
- knife edge
- maple legs/apron standard
- walnut legs/apron available, specify and add \$125 list

Round Coffee Table	42	42	17	45	16	BU42-17RDWL	\$1,194	\$1,244	\$2,761
	36	36	17	36	12	BU36-17RDWL	\$1,153	\$1,203	\$2,297



- ships KD
- three legs
- knife edge
- maple legs/apron standard
- walnut legs/apron available, specify and add \$125 list

Triangular Coffee Table	36	48	17	42	16	BU3648-17PKWL	\$1,197	\$1,247	\$2,764
--------------------------------	----	----	----	----	----	----------------------	----------------	----------------	----------------



- ships KD
- three legs
- knife edge
- maple legs/apron standard
- walnut legs/apron available, specify and add \$125 list



Description	D	W	H	CTN WT	CU FT	Model	Flat Cut or HPL Laminate Top	Double Cut Top	Solid Surface Top
Square Side Table	20	20	21	22	4	BU2020-21TTWL	\$1,141	\$1,191	\$1,595



- ships KD
- knife edge
- maple legs/apron standard
- walnut legs/apron available, specify and add \$125 list

Round Side Table	24	24	21	23	6	BU24-21RDWL	\$1,095	\$1,145	\$1,606
------------------	----	----	----	----	---	-------------	---------	---------	---------



- ships KD
- three legs
- knife edge
- maple legs/apron standard
- walnut legs/apron available, specify and add \$125 list

To Order, Specify:

- Model Number
- Top Material:
 - Veneer
 - Wood Species - Cherry (CH1), Maple (MA1), Walnut (WA1) or Double Cut (DC1)
 - Finish Color
 - Laminate
 - Laminate Color
 - Solid Surface - Pebble Pearl (PEB), Pure White (PUR) or Saddlebow Gray (SDB)
 - Legs/Apron Species:
 - Maple (M)
 - Finish Color or Paint Color on maple legs/apron
 - Walnut (W) - upcharge applies
 - Finish Color - walnut finishes only on walnut legs/apron

2a Veneer Top Finish Options:

Cherry		Maple		Walnut	
AUT	Autumn	ALE	Ale	AUB	Auburn
BRL	Barley	BUT	Butterscotch	ESP	Espresso
BBN	Bourbon	CIN	Cinnamon	MCH	Mocha
BRG	Brighton	FLX	Flax	NTO	Night Owl
CLA	Classic	VEN	Venetian	SIE	Sienna
EAR	Earthy			TOF	Toffee
LGC	Legacy			TRF	Truffle
PRL	Praline				
SAF	Saffron				

2b Laminate Top Options:

Veneer Grain Pattern Laminates			
AUB	Auburn	CLA	Classic
AUT	Autumn	GRH	Graphite
BRL	Barley	HGL	Highline
BLO	Blonde Echo	LGC	Legacy
BBN	Bourbon	MCH	Mocha
BZW	Brazilwood	NTO	Night Owl
BRG	Brighton	PRL	Praline
CIN	Cinnamon	SAF	Saffron

Solid Laminates

ALB	Alabaster	SHD	Shadow
BBL	Bridal Blanco	SLG	Slate Grey
DWH	Designer White	TAU	Taupe
DOV	Dove Grey		

2c Solid Surface Top Options:

PEB	Pebble Pearl
PUR	Pure White
SDB	Saddlebow Gray

3a Maple Legs/Apron Finish Options:

ALE	Ale	CGR	Graphite Coordinate
AUB	Auburn	CHL	High Line Coordinate
AUT	Autumn	CKC	Khaki Coordinate
BRL	Barley	LGC	Legacy
CBE	Blonde Echo Coordinate	MCH	Mocha
BBN	Bourbon	NTO	Night Owl
CBZ	Brazilwood Coordinate	PRL	Praline
BRG	Brighton	SAF	Saffron
BUT	Butterscotch	SIE	Sienna
CIN	Cinnamon	CST	Studio Teak Coordinate
CLA	Classic	TOF	Toffee
CCF	Coffee Coordinate	TRF	Truffle
CCR	Cremello Coordinate	VEN	Venetian
EAR	Earthy	CVI	Vintage Coordinate
ESP	Espresso	CWH	Walnut Heights Coordinate
FLX	Flax		

Paint Colors for Maple

BKD	Backdrop	GRV	Greek Villa
BFX	Black Fox	NET	Network Gray
BWH	Bright White	NWH	Nonchalant White
CGP	Cargo Pants	STM	Storm
CHT	Chatroom	TRC	Tricorn Black
FRR	French Roast		

3b Walnut Legs/Apron Finish Options:

AUB	Auburn
ESP	Espresso
MCH	Mocha
NTO	Night Owl
SIE	Sienna
TOF	Toffee
TRF	Truffle

Description	D	W	H	CTN WT	CU FT	① Model	Flat Cut Top	Double Cut Top
Tall Storage	18	30	42	115	6	BU1830-42STWR	\$2,454	\$2,604
	18	30	42	115	6	BU1830-42STWL	\$2,454	\$2,604



Left Shown

- hinged door cabinet contains two coat hooks standard
- open cabinet contains two adjustable shelves
- integrated clear anodized aluminum pull
- maple base standard
- walnut base available when walnut chassis is specified, specify and add \$125 list
- laminate top not available

Mid Storage	18	60	34	151	11	BU1860-34SCD	\$2,789	\$2,939
--------------------	----	----	----	-----	----	---------------------	---------	---------

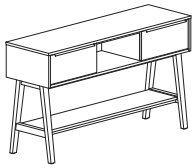

- two drawers
- open center cabinet
- veneer lower shelf
- integrated clear anodized aluminum pulls
- maple base standard
- walnut base available when walnut chassis is specified, specify and add \$200 list
- laminate top not available

Low Storage	18	60	24	145	11	BU1860-24SCHD	\$2,668	\$2,818
--------------------	----	----	----	-----	----	----------------------	---------	---------

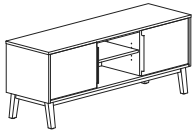

- two single hinged door cabinets - both contain one adjustable shelf
- open center cabinet has one adjustable shelf
- integrated clear anodized aluminum pulls
- maple base standard
- walnut base available when walnut chassis is specified, specify and add \$175 list
- laminate top not available

Description	D	W	H	CTN WT	CU FT	1 Model	List Price
Worksurface Power	2 3/8	6 3/8	3	3	1	EC26	\$476

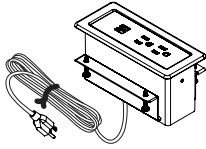

- (2) power receptacles
- (1) dual powered USB
- 120" power cord with molded plug
- White (W) or Black (B) finish available, specify when ordering
- UL recognized
- meets UL spill requirements

Under Surface Power	3	6 1/2	1 13/16	2	1	EC27	\$452
---------------------	---	-------	---------	---	---	------	-------

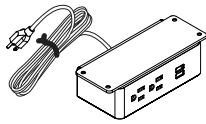

- (2) power receptacles
- (1) dual powered USB
- 120" power cord with molded plug
- White (W) or Black (B) finish available, specify when ordering
- UL recognized

To Order, Specify:

- 1 Model Number
- 2 Chassis Species - Cherry (CH1), Maple (MA1), Walnut (WA1) or Double Cut (DC1)
- 3 Base Species:
 - a.) Maple (M) - standard (finish same as chassis)
 - b.) Walnut (W) - upcharge applies; only available when walnut chassis is specified (finish same as chassis)
- 4 Chassis/Base Finish:
 - a.) Finish Color - cherry, maple, walnut, or double cut
- 5 Door Finish
 - a.) Wood Finish - same as chassis
 - b.) Paint Color

4a Chassis Finish Options:

<u>Cherry</u>		<u>Maple</u>		<u>Walnut</u>	
AUT	Autumn	ALE	Ale	AUB	Auburn
BRL	Barley	BUT	Butterscotch	ESP	Espresso
BBN	Bourbon	CIN	Cinnamon	MCH	Mocha
BRG	Brighton	FLX	Flax	NTO	Night Owl
CLA	Classic	VEN	Venetian	SIE	Sienna
EAR	Earthy			TOF	Toffee
LGC	Legacy			TRF	Truffle
PRL	Praline				
SAF	Saffron				
<u>Double Cut</u>					
COF	Coffee				
CRM	Cremello				
GRH	Graphite				
KHK	Khaki				
STU	Studio Teak				

5b Door Paint Color Options:

BKD	Backdrop	GRV	Greek Villa
BFX	Black Fox	NET	Network Gray
BWH	Bright White	NWH	Nonchalant White
CGP	Cargo Pants	STM	Storm
CHT	Chatroom	TRC	Tricorn Black
FRR	French Roast		

Index

BU24-21RDWL	31	BU4872-30TTML	22
BU36-17RDWL	30	BU4872-30TTWL	20
BU42-17RDWL	30	BU4872-36RTML	26
BU60-30RDML	23	BU4872-36RTWL	24
BU60-30RDWL	21	BU4872-36TTML	26
BU60-36RDML	27	BU4872-36TTWL	24
BU60-36RDWL	25	BU4872-40TTMLH	29
BU1830-42STWL	32	BU4872-40TTWLH	28
BU1830-42STWR	32	BU4884-30RTML	22
BU1860-24SCHD	32	BU4884-30RTWL	20
BU1860-34SCD	32	BU4884-30TTML	22
BU2020-21TTWL	31	BU4884-30TTWL	20
BU2448-17TTWL	30	BU4884-36RTML	26
BU3648-17PKWL	30	BU4884-36RTWL	24
BU3672-30TTML	22	BU4884-36TTML	26
BU3672-30TTWL	20	BU4884-36TTWL	24
BU3672-36TTML	26	BU4884-40TTMLH	29
BU3672-36TTWL	24	BU4884-40TTWLH	28
BU4242-17TTWL	30	BU4890-30RTML	22
BU4242-30TTML	23	BU4890-30RTWL	20
BU4242-30TTWL	21	BU4890-30TTML	22
BU4242-36TTML	27	BU4890-30TTWL	20
BU4242-36TTWL	25	BU4890-36RTML	26
BU4260-30RTML	22	BU4890-36RTWL	24
BU4260-30RTWL	20	BU4890-36TTML	26
BU4260-36RTML	26	BU4890-36TTWL	24
BU4260-36RTWL	24	BU4890-40TTMLH	29
BU4272-30RTML	22	BU4890-40TTWLH	28
BU4272-30RTWL	20	BU6060-30TTML	23
BU4272-30TTML	22	BU6060-30TTWL	21
BU4272-30TTWL	20	BU6060-36TTML	27
BU4272-36RTML	26	BU6060-36TTWL	25
BU4272-36RTWL	24	BU7504C	19
BU4272-36TTML	26	BU7511D	18
BU4272-36TTWL	24	BU7511E	18
BU4272-40TTMLH	29	BU7514D	19
BU4272-40TTWLH	28	BU7518D	19
BU4284-30RTML	22	BU7521D	18
BU4284-30RTWL	20	BU7521E	18
BU4284-30TTML	22	EC26	33
BU4284-30TTWL	20	EC27	33
BU4284-36RTML	26		
BU4284-36RTWL	24		
BU4284-36TTML	26		
BU4284-36TTWL	24		
BU4284-40TTMLH	29		
BU4284-40TTWLH	28		
BU4290-30RTML	22		
BU4290-30RTWL	20		
BU4290-30TTML	22		
BU4290-30TTWL	20		
BU4290-36RTML	26		
BU4290-36RTWL	24		
BU4290-36TTML	26		
BU4290-36TTWL	24		
BU4290-40TTMLH	29		
BU4290-40TTWLH	28		
BU4848-30TTML	23		
BU4848-30TTWL	21		
BU4848-36TTML	27		
BU4848-36TTWL	25		
BU4872-30RTML	22		
BU4872-30RTWL	20		

Reef Product Information

▲ Updated 11/1/16



Panel Table	10-12
Wall Dependent Panel Table	13
Layered Table	14-16
Wall Dependent Layered Table	17
Layered Table with Asymmetric Bookshelf	18-20
Wall Dependent Layered Table with Asymmetric Bookshelf.	21-23
Layered Table with Full Width Bookcases.	24
Wall Dependent Layered Table with Full Width Bookcases	24
Vertical Wire Manager	25
Power	26

Reef Product Information

Reef Veneer

Exterior Wood Materials

Exterior surfaces are made from the finest selected veneers to achieve clarity and consistency in the Reef Veneer product line. To attain a pleasing, symmetrical pattern, all cherry, maple and walnut veneers are book-matched.

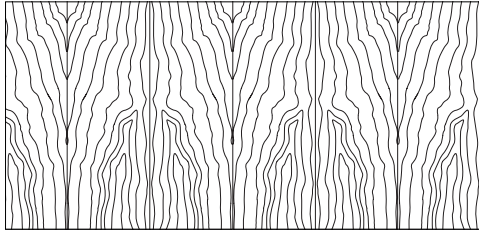

Book-Matched Example

Alternating pieces of veneer are flipped over so they face each other like the pages within a book.

Reef Veneer is available in flat cut cherry, maple and walnut. A wide range of wood stains have been formulated to enhance the beauty of the veneer.

Double Cut veneer is another choice on Reef Veneer product. This veneer is a processed product that has at least two cuttings to create the final veneers. These cuts of veneer strands are dyed and layered into a block to create variation of patterns from a very tight grain pattern to an exotic figure grain pattern.

The diagram below shows the tight pattern used on Reef Double Cut Veneer.

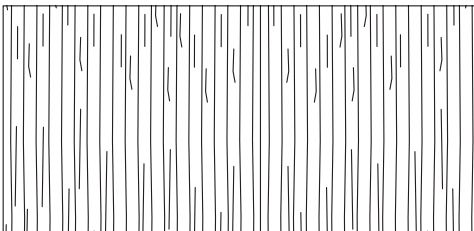

Worksurface Construction

Worksurfaces are 1 3/16" thick and are manufactured with 3-ply balanced construction. Surfaces are available in wood veneer or high pressure laminate. No additional charge for HPL worksurface when using the JSI standard coordinating HPL match to a standard wood finish. Veneer tops feature 3mm thick matching veneer edgebands. HPL tops are constructed with internal solid hardwood lumber edgebands.

Case Construction

Reef Veneer end panels are produced using a 1 3/16" thick substrate with veneer surfaces and matching veneer bands on exposed edges. Stretcher panels are 1 3/16" thick for layered tables and 3/4" thick on panel tables. Stretcher panels feature heavy duty metal brackets that bolt to metal insert nuts in end panels. Reef 36", 42" and 48" deep tables feature dual stretcher panels that are sized to provide proper support for worksurfaces. Reef 20" deep wall dependent tables incorporate rear stretcher and metal support rails for worksurface support. Worksurfaces are joined to end assemblies and stretcher panels by metal brackets and wood screws. Upper shelves on layered tables are 1 3/16" thick and attach with Modeez connectors and metal brackets with wood screws. Bookcase sections are constructed from 3/4" thick veneer panels with matching veneer edgebanding. Narrow bookcase and full bookcase joinery includes wood cleats, wood screws and metal fasteners. All tables have adjustable leveling glides. Reef tables require field assembly.

Foot Rails

Optional metal foot rails are constructed with 14-gauge 1 3/4" square tubing with powder coated finish. Rails attach to end panels using 1/4-20 machine screws into metal inserts in end panels.

Finish - Stain/Colors

We offer a variety of wood stains and paint colors on Reef. Please see the chart below. Samples are available upon request. Former finish names are listed in parentheses for reference.

CH1 Cherry Flat Cut Veneer

AUT Autumn (<i>Autumn Cherry</i>)	EAR Earthy
BRL Barley	LGC Legacy (<i>Legacy Cherry</i>)
BBN Bourbon (<i>Natural Cherry</i>)	PRL Praline (<i>Vintage Cherry</i>)
BRG Brighton (<i>Brighton Cherry</i>)	SAF Saffron (<i>Medium Cherry</i>)
CLA Classic (<i>Classic Cherry</i>)	

MA1 Maple Flat Cut Veneer

ALE Ale (<i>Natural Maple</i>)	FLX Flax
BUT Butterscotch	VEN Venetian (<i>Dark Mahogany</i>)
CIN Cinnamon	

WA1 Walnut Flat Cut Veneer

AUB Auburn (<i>Windsor Mahogany</i>)	SIE Sienna
ESP Espresso	TOF Toffee
MCH Mocha	TRF Truffle
NTO Night Owl (<i>Vintage Walnut</i>)	

DC1 Double Cut Veneer

COF Coffee	KHK Khaki
CRM Cremello	STU Studio Teak
GRH Graphite	

PNT Paint

BKD Backdrop	GRV Greek Villa
BFX Black Fox	NET Network Gray
BWH Bright White	NWH Nonchalant White
CGP Cargo Pants	STM Storm
CHT Chatroom	TRC Tricorn Black
FRR French Roast	

Protective Top Coat

DuraTex™ offers exceptional hardness along with abrasion and impact resistance, it has been formulated to eliminate hazardous and harmful gases that are normally associated with wood finish.

DuraTex™ Features

Safety - Significantly reduces hazardous formaldehyde emissions which help improve the quality of the indoor air we breathe. **Quality** - Developed to be tough and durable with special attention to appearance. The DuraTex™ finish preserves the natural beauty of wood. **Durability** - Designed to meet a wide range of demanding performance and environmental standards to withstand even the highest wear and tear.

Custom/Special Finishes

JSI, upon request, will accommodate special finishes. A written request is required to proceed with custom finish orders. A sample reference is required for first time matches and must be included with the written request.

There is a one time charge of \$289 list per order for any non-standard wood finish.

Reef Product Information

Orders will be entered noting the special finish. A sample match will be provided to the customer. Written approval is needed before the finish process can be started. Delays in approval may have an impact on lead times.

Every effort will be made to create the requested match; however, an acceptable match may not be possible because of natural variations of wood. These natural variations can also cause minor differences in the final finish product.

Oak Veneer

Upon request veneer can be changed from the standard offering to oak plain sliced veneer with a 40% upcharge on to the list of each item.

Laminate Tops

Work surface only, no additional upcharge if Reef's coordinating wood grain laminate is specified. Contact Customer Service for any other laminate request. Listed below are finishes that have coordinating wood grain HPL laminates.

Cherry Finishes	Maple Finishes	Walnut Finishes
Autumn	Ale	Auburn
Barley	Cinnamon	Mocha
Bourbon	Venetian	Night Owl
Brighton		Sienna
Classic		Toffee
Legacy		Truffle
Praline		
Saffron		

Reef Laminate

Reef Laminate features TFL (thermally fused laminate) chassis components. Worksurfaces are available in TFL or HPL (high pressure laminate).

Edges of the worksurface are banded with impact resistant (PVC) on both TFL and HPL tops. The laminate is offered in 10 wood grain patterns and 7 solid colors. Wood grain laminates feature an embossed grain that adds texture and helps to hide finger prints and light scratches. The solid color laminates are smooth to the touch with a semi-matte finish. All Reef Laminate products are indoor-air certified by GreenGuard.

The chart below lists the laminates available on the Reef product. Former laminate names are listed in parentheses for reference.

TFL - HPL Wood Grain Pattern Laminates

AUT Autumn (<i>Autumn Cherry</i>)	HGL High Line
BLO Blonde Echo	SHE Shea (<i>Nat Maple/Ale finish match</i>)
BBN Bourbon (<i>Natural Cherry</i>)	STU Studio Teak
BZW Brazilwood	WLH Walnut Heights
BRG Brighton (<i>Brighton Cherry</i>)	VIN Vintage (<i>Vintage Cherry</i>)
GRH Graphite	

TFL - HPL Solid Laminates

ALB Alabaster	SHD Shadow
BBL Bridal Blanco	SLG Slate Grey
DWH Designer White	TAU Taupe
DOV Dove Grey	

Worksurfaces

Worksurfaces are manufactured with 3-ply balanced construction. Tops are 1 3/16" thick with coordinating PVC edges. Worksurfaces feature 3mm PVC edges on user sides. Edge detail is flat with eased edge on top and bottom. Worksurface ends are banded with 1mm PVC. Worksurfaces are offered in TFL or HPL.

TFL Features on Worksurfaces

Fused to 45 lb density substrate of the top for a durable surface. Tops are laminated on both sides. Available in all the wood grain and solid patterns.

HPL Features on Worksurfaces

Fusion of multiple layers creates a higher impact resistant surface. Tops are 3-ply balanced construction. Available in all wood grain and solid patterns.

Case Construction

Reef Laminate end panels are produced using 1 3/16" thick substrate with TFL surfaces and matching PVC bands on exposed edges. Stretcher panels are 1 3/16" thick for layered tables and 3/4" thick on panel tables. Stretcher Panels feature heavy duty metal brackets that bolt to metal insert nuts in end panels. Reef 36", 42" and 48" deep tables feature dual stretcher panels that are sized to provide proper support for worksurfaces. Reef 20" deep wall dependent tables incorporate rear stretcher and metal support rails for work surface support. Worksurfaces are joined to end assemblies and stretcher panels by metal brackets and wood screws. Upper shelves on layered tables are 1 1/8" thick and attach with Modeez connectors and metal brackets. Bookcase sections are constructed from 3/4" thick TFL panels with 1mm edgebanding. Narrow bookcase and full bookcase assembly joinery include wood cleats, wood screws and metal fasteners. All tables have adjustable leveling glides. Reef tables require field assembly.

Foot Rails

Optional metal foot rails are constructed with 14-gauge 1 3/4" square tubing with powder coated finish. Rails attach to end panels using 1/4"-20 machine screws into metal inserts in end panels.

Reef Product Information

Table Overview

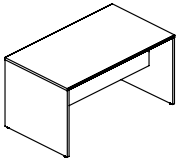

Panel Table

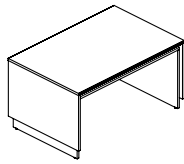

Layered Table

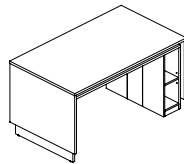

Layered Table with Asymmetric Bookshelf

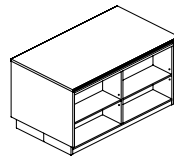

Layered Table with Full Width Bookcases

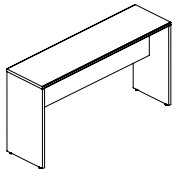

Wall Dependent Panel Table

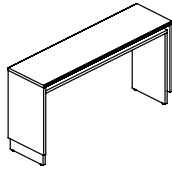

Wall Dependent Layered Table

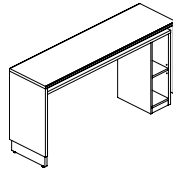

Wall Dependent Layered Table with Asymmetric Bookshelf

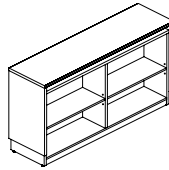

Wall Dependent Layered Table with Full Width Bookcases

Reef

Reef Product Information

Optional Foot Rail

Optional foot rail in the Arctic Silver, Black Sandtex or Soft Nickel powder coat finish is available on the 42" h tables.

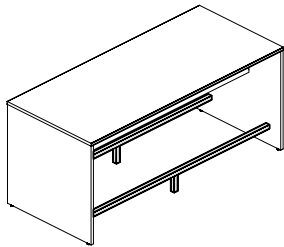

96" wide

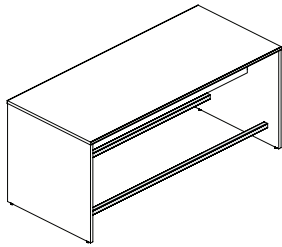

54", 60", 72", & 84" wide

Double Sided Table - Two Rails - add \$772 list
 Single Sided Table - One Rail - add \$416 list

Optional Coat Hook

Optional satin stainless steel coat hook is available on the 42" h and 37" h tables.

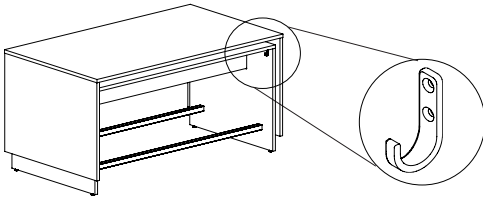

Double Sided Table - Four Hooks - add \$140 list
 Single Sided Table - Two Hooks - add \$84 list

Vertical Wire Manager

Vertical Wire Manager is optional on the 48", 42" and 36" deep units, select veneer or laminate.

Bookcases feature integrated vertical wire management with a removable access panel. Vertical wire managers are not available on bookcase sides.

Note: Not available on 20" d units.

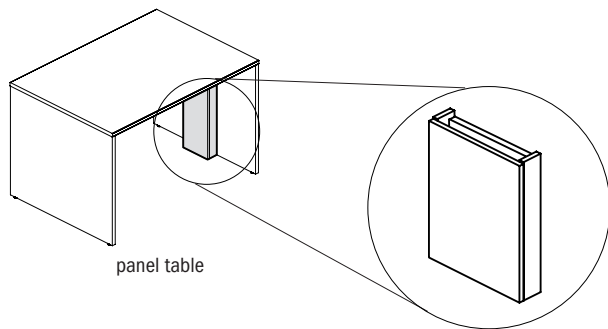

panel table

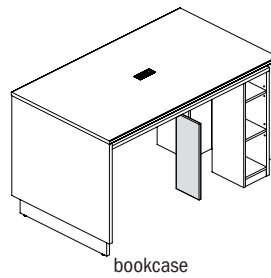

bookcase

Reef Product Information

Chart below should be used when determining appropriate Vertical Wire Manager for Panel Tables.

Depth	Table		Vertical Wire Manager		Depth	Table		Vertical Wire Manager	
	Width	Height	Veneer	Laminate		Width	Height	Veneer	Laminate
48	96	42	REV1617WMA	RET1617WMA	48	96	30	REV1617WMA	RET1617WMA
48	84	42	REV1617WMA	RET1617WMA	48	84	30	REV1617WMA	RET1617WMA
48	72	42	REV1617WMA	RET1617WMA	48	72	30	REV1617WMA	RET1617WMA
48	60	42	REV1617WMA	RET1617WMA	48	60	30	REV1617WMA	RET1617WMA
48	54	42	REV1617WMA	RET1617WMA	48	54	30	REV1617WMA	RET1617WMA
42	96	42	REV1017WMA	RET1017WMA	42	96	30	REV1017WMA	RET1017WMA
42	84	42	REV1017WMA	RET1017WMA	42	84	30	REV1017WMA	RET1017WMA
42	72	42	REV1017WMA	RET1017WMA	42	72	30	REV1017WMA	RET1017WMA
42	60	42	REV1017WMA	RET1017WMA	42	60	30	REV1017WMA	RET1017WMA
42	54	42	REV1017WMA	RET1017WMA	42	54	30	REV1017WMA	RET1017WMA
36	96	42	REV1017WMA	RET1017WMA	36	96	30	REV1017WMA	RET1017WMA
36	84	42	REV1017WMA	RET1017WMA	36	84	30	REV1017WMA	RET1017WMA
36	72	42	REV1017WMA	RET1017WMA	36	72	30	REV1017WMA	RET1017WMA
36	60	42	REV1017WMA	RET1017WMA	36	60	30	REV1017WMA	RET1017WMA
36	54	42	REV1017WMA	RET1017WMA	36	54	30	REV1017WMA	RET1017WMA
48	96	37	REV1617WMA	RET1617WMA					
48	84	37	REV1617WMA	RET1617WMA					
48	72	37	REV1617WMA	RET1617WMA					
48	60	37	REV1617WMA	RET1617WMA					
48	54	37	REV1617WMA	RET1617WMA					
42	96	37	REV1017WMA	RET1017WMA					
42	84	37	REV1017WMA	RET1017WMA					
42	72	37	REV1017WMA	RET1017WMA					
42	60	37	REV1017WMA	RET1017WMA					
42	54	37	REV1017WMA	RET1017WMA					
36	96	37	REV1017WMA	RET1017WMA					
36	84	37	REV1017WMA	RET1017WMA					
36	72	37	REV1017WMA	RET1017WMA					
36	60	37	REV1017WMA	RET1017WMA					
36	54	37	REV1017WMA	RET1017WMA					

Reef

Reef Product Information

Chart below should be used when determining appropriate Vertical Wire Manager for Layered Tables and Layered Tables with Asymmetric Bookshelf.

Table			Vertical Wire Manager	
Depth	Width	Height	Veneer	Laminate
48	96	42	REV1626WMA	RET1626WMA
48	84	42	REV1626WMA	RET1626WMA
48	72	42	REV1626WMA	RET1626WMA
48	60	42	REV1626WMA	RET1626WMA
48	54	42	REV1626WMA	RET1626WMA
42	96	42	REV1026WMA	RET1026WMA
42	84	42	REV1026WMA	RET1026WMA
42	72	42	REV1026WMA	RET1026WMA
42	60	42	REV1026WMA	RET1026WMA
42	54	42	REV1026WMA	RET1026WMA
36	96	42	REV1026WMA	RET1026WMA
36	84	42	REV1026WMA	RET1026WMA
36	72	42	REV1026WMA	RET1026WMA
36	60	42	REV1026WMA	RET1026WMA
36	54	42	REV1026WMA	RET1026WMA
48	96	37	REV1626WMA	RET1626WMA
48	84	37	REV1626WMA	RET1626WMA
48	72	37	REV1626WMA	RET1626WMA
48	60	37	REV1626WMA	RET1626WMA
48	54	37	REV1626WMA	RET1626WMA
42	96	37	REV1026WMA	RET1026WMA
42	84	37	REV1026WMA	RET1026WMA
42	72	37	REV1026WMA	RET1026WMA
42	60	37	REV1026WMA	RET1026WMA
42	54	37	REV1026WMA	RET1026WMA
36	96	37	REV1026WMA	RET1026WMA
36	84	37	REV1026WMA	RET1026WMA
36	72	37	REV1026WMA	RET1026WMA
36	60	37	REV1026WMA	RET1026WMA
36	54	37	REV1026WMA	RET1026WMA

Table			Vertical Wire Manager	
Depth	Width	Height	Veneer	Laminate
48	96	30	REV1620WMA	RET1620WMA
48	84	30	REV1620WMA	RET1620WMA
48	72	30	REV1620WMA	RET1620WMA
48	60	30	REV1620WMA	RET1620WMA
48	54	30	REV1620WMA	RET1620WMA
42	96	30	REV1020WMA	RET1020WMA
42	84	30	REV1020WMA	RET1020WMA
42	72	30	REV1020WMA	RET1020WMA
42	60	30	REV1020WMA	RET1020WMA
42	54	30	REV1020WMA	RET1020WMA
36	96	30	REV1020WMA	RET1020WMA
36	84	30	REV1020WMA	RET1020WMA
36	72	30	REV1020WMA	RET1020WMA
36	60	30	REV1020WMA	RET1020WMA
36	54	30	REV1020WMA	RET1020WMA

Reef Product Information

Optional Worksurface Power

Optional Worksurface Power (EC26) is available on 48", 42" and 36" deep units. Indicate "to accommodate Worksurface Power" on your purchase order. When this option is specified the worksurface will have one cut out in the center. One EC26 Worksurface Power unit must be ordered separately, see page 26. Length of cord is 10 feet.

Note: Not available on wall dependent tables or tables with full width bookcases.

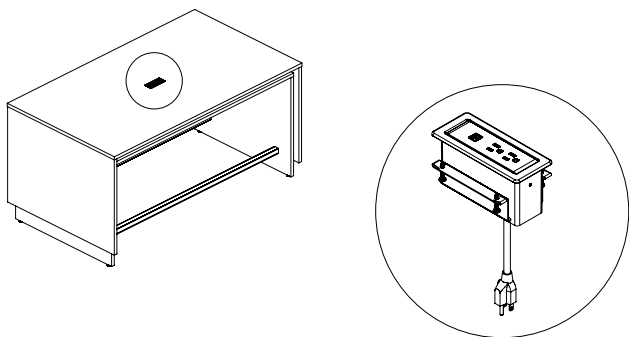

Under Surface Power

Under Surface Power (EC27) may be ordered for 48", 42", 36" and 20" deep units. The 48", 42" and 36" deep units can accommodate power unit on each side of the table. The 20" deep units can accommodate power units on the non-wall side. The EC27 Under Surface Power Unit(s) must be ordered separately, see page 26. This unit is field installed. Length of cord is 10 feet.

Note: Not available on tables with full width bookcases.

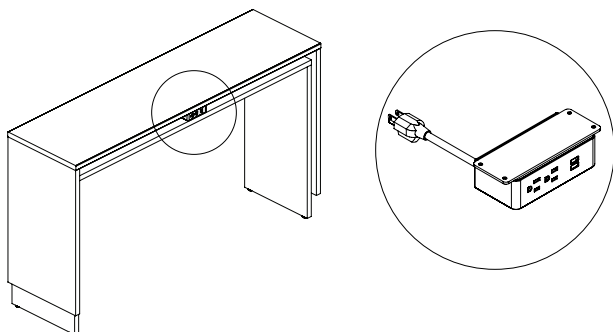

Edge Mount Power

Edge Mount Power (EC28) may be ordered for 20" deep units. This unit is field installed. Ordering information can be found on page 26. Length of power cord is 6 feet.

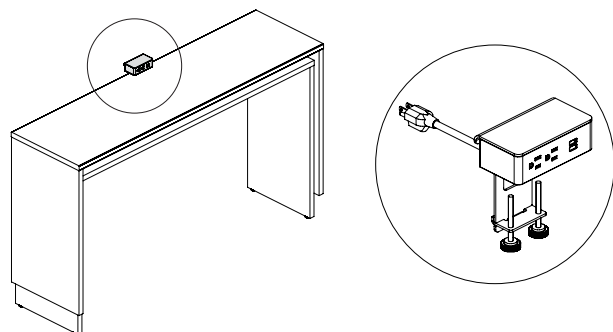

Reef Product Information

Material Options

Note: Only one veneer can be specified.

Panel Table

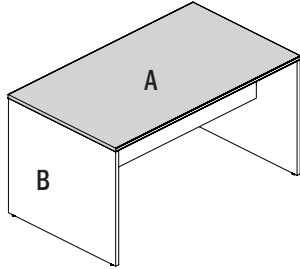

- REV - Veneer**
A Worksurface
 Veneer
B Panels
 Veneer
 Paint

Note: Stretcher matches "B"

- RET - Laminate**
A Worksurface
 Laminate
B Panels
 Laminate

Note: Stretcher matches "B"

Layered Table

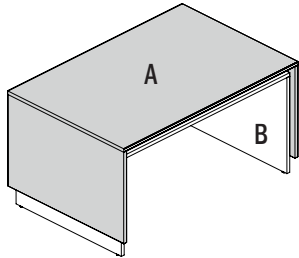

- REV - Veneer**
A Worksurface/Outer Panels
 Veneer
B Inner Panels
 Veneer
 Paint

Note: Stretcher matches "B"

- RET - Laminate**
A Worksurface/Outer Panels
 Laminate
B Inner Panels
 Laminate

Note: Stretcher matches "B"

Layered Table with Asymmetric Bookshelf

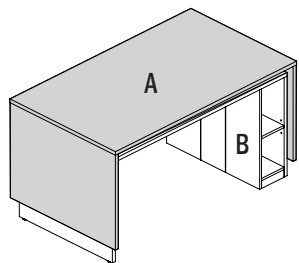

- REV - Veneer**
A Worksurface/Outer Panels
 Veneer
B Bookcase/Inner Panels
 Veneer
 Paint

Note: Stretcher matches "B"

- RET - Laminate**
A Worksurface/Outer Panels
 Laminate
B Bookcase/Inner Panels
 Laminate

Note: Stretcher matches "B"

Layered Table with Full Width Bookcase

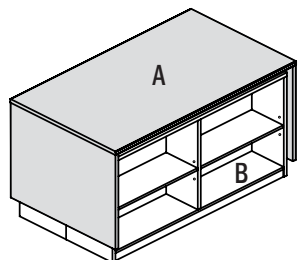

- REV - Veneer**
A Worksurface/Outer Panels
 Veneer
B Bookcase/Inner Panels
 Veneer
 Paint

Note: Stretcher matches "B"

- RET - Laminate**
A Worksurface/Outer Panels
 Laminate
B Bookcase/Inner Panels
 Laminate

Note: Stretcher matches "B"

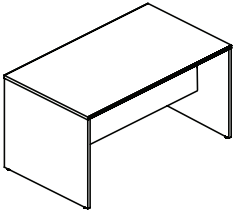
Description	D	W	H	CTN WT	CU FT	① Model	Veneer Flat Cut and Double Cut List Price	TFL Laminate List Price	HPL Laminate List Price
42" h Panel Table 	48	96	42	317	34	REV4896-42PT	\$3409		
	48	96	42	317	34	RET4896-42PT		\$1483	\$2017
	48	84	42	292	31	REV4884-42PT	\$3,216		
	48	84	42	292	31	RET4884-42PT		\$1,399	\$1,902
	48	72	42	267	28	REV4872-42PT	\$3,029		
	48	72	42	267	28	RET4872-42PT		\$1,314	\$1,771
	48	60	42	241	25	REV4860-42PT	\$2861		
	48	60	42	241	25	RET4860-42PT		\$1,238	\$1,654
	48	54	42	229	24	REV4854-42PT	\$2,786		
	48	54	42	229	24	RET4854-42PT		\$1,205	\$1,601
	42	96	42	288	31	REV4296-42PT	\$3214		
	42	96	42	288	31	RET4296-42PT		\$1398	\$1886
	42	84	42	264	28	REV4284-42PT	\$3,032		
	42	84	42	264	28	RET4284-42PT		\$1,318	\$1,779
	42	72	42	241	26	REV4272-42PT	\$2,856		
	42	72	42	241	26	RET4272-42PT		\$1,238	\$1,657
	42	60	42	218	23	REV4260-42PT	\$2,699		
	42	60	42	218	23	RET4260-42PT		\$1,167	\$1,547
	42	54	42	206	22	REV4254-42PT	\$2,628		
	42	54	42	206	22	RET4254-42PT		\$1,137	\$1,499
	36	96	42	258	28	REV3696-42PT	\$2958		
	36	96	42	258	28	RET3696-42PT		\$1286	\$1736
	36	84	42	237	25	REV3684-42PT	\$2,790		
	36	84	42	237	25	RET3684-42PT		\$1,213	\$1,637
	36	72	42	216	23	REV3672-42PT	\$2,628		
	36	72	42	216	23	RET3672-42PT		\$1,140	\$1,525
	36	60	42	194	20	REV3660-42PT	\$2,484		
	36	60	42	194	20	RET3660-42PT		\$1,075	\$1,424
	36	54	42	184	19	REV3654-42PT	\$2,418		
	36	54	42	184	19	RET3654-42PT		\$1,046	\$1,379

- ships KD
- vertical kneespace clearance 40 3/4"
- EC26 worksurface power available, specify "to accommodate worksurface power" on your purchase order; one EC26 unit must be ordered separately, see page 26
- EC27 undersurface power available, see page 26
- wire manager available, see page 25
- optional foot rail (two rails), specify and add \$772 list
- optional coat hooks (four hooks), specify and add \$140 list

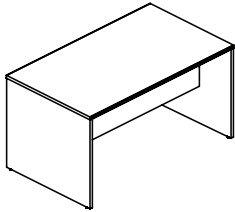
Description	D	W	H	CTN WT	CU FT	① Model	Veneer Flat Cut and Double Cut List Price	TFL Laminate List Price	HPL Laminate List Price
37" h Panel Table 	48	96	37	286	32	REV4896-37PT	\$3209		
	48	96	37	286	32	RET4896-37PT		\$1381	\$1894
	48	84	37	263	29	REV4884-37PT	\$3,027		
	48	84	37	263	29	RET4884-37PT		\$1,302	\$1,786
	48	72	37	240	26	REV4872-37PT	\$2,853		
	48	72	37	240	26	RET4872-37PT		\$1,218	\$1,656
	48	60	37	218	23	REV4860-37PT	\$2,697		
	48	60	37	218	23	RET4860-37PT		\$1,142	\$1,539
	48	54	37	206	22	REV4854-37PT	\$2,628		
	48	54	37	206	22	RET4854-37PT		\$1,108	\$1,488
	42	96	37	258	29	REV4296-37PT	\$3021		
	42	96	37	258	29	RET4296-37PT		\$1292	\$1760
	42	84	37	237	26	REV4284-37PT	\$2,850		
	42	84	37	237	26	RET4284-37PT		\$1,218	\$1,660
	42	72	37	216	24	REV4272-37PT	\$2,687		
	42	72	37	216	24	RET4272-37PT		\$1,139	\$1,540
	42	60	37	196	21	REV4260-37PT	\$2,541		
	42	60	37	196	21	RET4260-37PT		\$1,069	\$1,433
	42	54	37	185	20	REV4254-37PT	\$2,477		
	42	54	37	185	20	RET4254-37PT		\$1,038	\$1,386
	36	96	37	229	25	REV3696-37PT	\$2780		
	36	96	37	229	25	RET3696-37PT		\$1189	\$1620
	36	84	37	211	23	REV3684-37PT	\$2,622		
	36	84	37	211	23	RET3684-37PT		\$1,121	\$1,528
	36	72	37	192	21	REV3672-37PT	\$2,472		
	36	72	37	192	21	RET3672-37PT		\$1,049	\$1,417
	36	60	37	173	19	REV3660-37PT	\$2,339		
	36	60	37	173	19	RET3660-37PT		\$984	\$1,319
	36	54	37	164	18	REV3654-37PT	\$2,279		
	36	54	37	164	18	RET3654-37PT		\$956	\$1,276

- ships KD
- vertical kneespace clearance 35 3/4"
- EC26 worksurface power available, specify "to accommodate worksurface power" on your purchase order; one EC26 unit must be ordered separately, see page 26
- EC27 undersurface power available, see page 26
- wire manager available, see page 25
- optional coat hooks (four hooks), specify and add \$140 list

To Order, Specify:

Veneer

- ① Model Number
- ② Worksurface Wood Species - Cherry (CH1), Maple (MA1), Walnut (WA1) or Double Cut (DC1) (see page 2)
- ③ Finish Color (see page 2)

- ④ Panels Species & Finish
 - a.) Same as Worksurface
 - b.) Paint (see page 2)
- ⑤ Other Product Options

Laminate

- ① Model Number
- ② Worksurface Material (see page 3)
 - a.) TFL
 - b.) HPL
- ③ Worksurface Laminate Color (see page 3)
- ④ Panels Laminate Color
 - a.) Same as Worksurface
 - b.) Other Laminate (see page 3)
- ⑤ Other Product Options

Description	D	W	H	CTN WT	CU FT	① Model	Veneer Flat Cut and Double Cut List Price	TFL Laminate List Price	HPL Laminate List Price
30" h Panel Table	48	96	30	254	29	REV4896-30PT	\$3012		
	48	96	30	254	29	RET4896-30PT		\$1287	\$1783
	48	84	30	233	26	REV4884-30PT	\$2,841		
	48	84	30	233	26	RET4884-30PT		\$1,214	\$1,682
	48	72	30	211	24	REV4872-30PT	\$2,675		
	48	72	30	211	24	RET4872-30PT		\$1,128	\$1,548
	48	60	30	190	21	REV4860-30PT	\$2,526		
	48	60	30	190	21	RET4860-30PT		\$1,051	\$1,428
	48	54	30	179	20	REV4854-30PT	\$2,460		
	48	54	30	179	20	RET4854-30PT		\$1,018	\$1,375
	42	96	30	229	26	REV4296-30PT	\$2839		
	42	96	30	229	26	RET4296-30PT		\$1219	\$1672
	42	84	30	209	24	REV4284-30PT	\$2,678		
	42	84	30	209	24	RET4284-30PT		\$1,150	\$1,577
	42	72	30	190	21	REV4272-30PT	\$2,522		
	42	72	30	190	21	RET4272-30PT		\$1,068	\$1,453
	42	60	30	171	19	REV4260-30PT	\$2,382		
	42	60	30	171	19	RET4260-30PT		\$996	\$1,341
	42	54	30	161	18	REV4254-30PT	\$2,321		
	42	54	30	161	18	RET4254-30PT		\$964	\$1,291
	36	96	30	203	23	REV3696-30PT	\$2613		
	36	96	30	203	23	RET3696-30PT		\$1122	\$1540
	36	84	30	186	21	REV3684-30PT	\$2,465		
	36	84	30	186	21	RET3684-30PT		\$1,058	\$1,452
	36	72	30	168	19	REV3672-30PT	\$2,321		
	36	72	30	168	19	RET3672-30PT		\$983	\$1,338
	36	60	30	151	17	REV3660-30PT	\$2,192		
	36	60	30	151	17	RET3660-30PT		\$917	\$1,235
	36	54	30	142	16	REV3654-30PT	\$2,136		
	36	54	30	142	16	RET3654-30PT		\$888	\$1,188

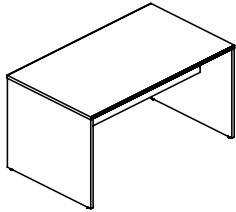

Reef

- ships KD
- vertical kneespace clearance 28 3/4"
- EC26 worksurface power available, specify "to accommodate worksurface power" on your purchase order; one EC26 unit must be ordered separately, see page 26
- EC27 undersurface power available, see page 26
- wire manager available, see page 25

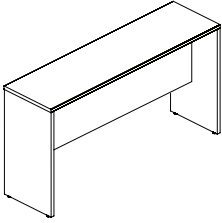
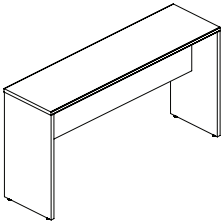
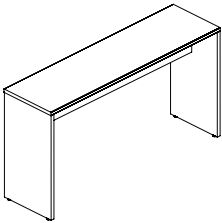
Description	D	W	H	CTN WT	CU FT	① Model	Veneer Flat Cut and Double Cut List Price	TFL Laminate List Price	HPL Laminate List Price	
20"d Wall Dependent Panel Table 	20	84	42	105	14	REV2084-42PT	\$1,913			
	20	84	42	105	14	RET2084-42PT		\$801	\$1,062	
	20	72	42	94	13	REV2072-42PT	\$1,814			
	20	72	42	94	13	RET2072-42PT		\$759	\$997	
	20	60	42	83	12	REV2060-42PT	\$1,715			
	20	60	42	83	12	RET2060-42PT		\$721	\$939	
	20	54	42	77	11	REV2054-42PT	\$1,670			
	20	54	42	77	11	RET2054-42PT		\$705	\$913	
		20	84	37	94	13	REV2084-37PT	\$1,811		
		20	84	37	94	13	RET2084-37PT		\$740	\$994
		20	72	37	84	12	REV2072-37PT	\$1,707		
		20	72	37	84	12	RET2072-37PT		\$692	\$922
		20	60	37	74	11	REV2060-37PT	\$1,614		
		20	60	37	74	11	RET2060-37PT		\$650	\$858
20		54	37	69	10	REV2054-37PT	\$1,574			
20		54	37	69	10	RET2054-37PT		\$632	\$830	
	20	84	30	85	12	REV2084-30PT	\$1,701			
	20	84	30	85	12	RET2084-30PT		\$699	\$945	
	20	72	30	76	11	REV2072-30PT	\$1,602			
	20	72	30	76	11	RET2072-30PT		\$649	\$871	
	20	60	30	66	10	REV2060-30PT	\$1,514			
	20	60	30	66	10	RET2060-30PT		\$605	\$804	
	20	54	30	62	9	REV2054-30PT	\$1,475			
	20	54	30	62	9	RET2054-30PT		\$587	\$772	

- ships KD
- intended for use against a wall, does not attach to the wall
- exposed hardware on back side
- EC27 undersurface power available, see page 26
- EC28 edge mount power available, see page 26
- optional foot rail available on 42" table, specify and add \$416 list
- optional coat hooks (two hooks) available on 42" and 37" tables, specify and add \$84 list
- vertical kneespace clearance for 42" panel table - 40 3/4"
- vertical kneespace clearance for 37" panel table - 35 3/4"
- vertical kneespace clearance for 30" panel table - 28 3/4"

To Order, Specify:

Veneer

- ① Model Number
- ② Worksurface Wood Species - Cherry (CH1), Maple (MA1), Walnut (WA1) or Double Cut (DC1) (see page 2)
- ③ Finish Color (see page 2)

- ④ Panels Species & Finish
 - a.) Same as Worksurface
 - b.) Paint (see page 2)
- ⑤ Other Product Options

Laminate

- ① Model Number
- ② Worksurface Material (see page 3)
 - a.) TFL
 - b.) HPL
- ③ Worksurface Laminate Color (see page 3)
- ④ Panels Laminate Color
 - a.) Same as Worksurface
 - b.) Other Laminate (see page 3)
- ⑤ Other Product Options

Description	D	W	H	CTN WT	CU FT	① Model	Veneer Flat Cut and Double Cut List Price	TFL Laminate List Price	HPL Laminate List Price
42" h Layered Table	48	96	42	443	44	REV4896-42LT	\$4671		
	48	96	42	443	44	RET4896-42LT		\$2095	\$2761
	48	84	42	409	40	REV4884-42LT	\$4,406		
	48	84	42	409	40	RET4884-42LT		\$1,976	\$2,604
	48	72	42	375	37	REV4872-42LT	\$4,149		
	48	72	42	375	37	RET4872-42LT		\$1,856	\$2,425
	48	60	42	340	33	REV4860-42LT	\$3,920		
	48	60	42	340	33	RET4860-42LT		\$1,750	\$2,265
	48	54	42	323	31	REV4854-42LT	\$3,816		
	48	54	42	323	31	RET4854-42LT		\$1,702	\$2,192
	42	96	42	407	41	REV4296-42LT	\$4459		
	42	96	42	407	41	RET4296-42LT		\$1993	\$2592
	42	84	42	375	37	REV4284-42LT	\$4,206		
	42	84	42	375	37	RET4284-42LT		\$1,880	\$2,445
	42	72	42	342	33	REV4272-42LT	\$3,962		
	42	72	42	342	33	RET4272-42LT		\$1,767	\$2,277
	42	60	42	310	30	REV4260-42LT	\$3,744		
	42	60	42	310	30	RET4260-42LT		\$1,665	\$2,127
	42	54	42	294	28	REV4254-42LT	\$3,647		
	42	54	42	294	28	RET4254-42LT		\$1,621	\$2,060
	36	96	42	355	36	REV3696-42LT	\$4103		
	36	96	42	355	36	RET3696-42LT		\$1834	\$2387
	36	84	42	327	33	REV3684-42LT	\$3,870		
	36	84	42	327	33	RET3684-42LT		\$1,730	\$2,251
	36	72	42	299	29	REV3672-42LT	\$3,647		
	36	72	42	299	29	RET3672-42LT		\$1,626	\$2,096
	36	60	42	270	26	REV3660-42LT	\$3,446		
	36	60	42	270	26	RET3660-42LT		\$1,533	\$1,957
	36	54	42	256	25	REV3654-42LT	\$3,354		
	36	54	42	256	25	RET3654-42LT		\$1,492	\$1,896

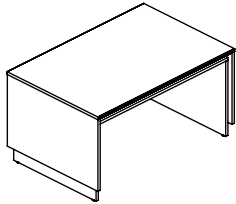

Reef

- ships KD
- vertical kneespace clearance 36 5/8"
- vertical shelf clearance 2 15/16"
- EC26 worksurface power available, specify "to accommodate worksurface power" on your purchase order; one EC26 unit must be ordered separately, see page 26
- EC27 undersurface power available, see page 26
- wire manager available, see page 25
- optional foot rail (two rails), specify and add \$772 list
- optional coat hooks (four hooks), specify and add \$140 list

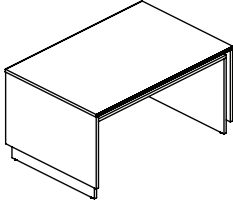
Description	D	W	H	CTN WT	CU FT	① Model	Veneer Flat Cut and Double Cut List Price	TFL Laminate List Price	HPL Laminate List Price
	48	96	37	407	41	REV4896-37LT	\$4416		
	48	96	37	407	41	RET4896-37LT		\$1956	\$2595
	48	84	37	375	38	REV4884-37LT	\$4,166		
	48	84	37	375	38	RET4884-37LT		\$1,845	\$2,448
	48	72	37	343	34	REV4872-37LT	\$3,927		
	48	72	37	343	34	RET4872-37LT		\$1,727	\$2,270
	48	60	37	312	30	REV4860-37LT	\$3,713		
	48	60	37	312	30	RET4860-37LT		\$1,619	\$2,111
	48	54	37	296	29	REV4854-37LT	\$3,617		
	48	54	37	296	29	RET4854-37LT		\$1,571	\$2,040
	42	96	37	372	38	REV4296-37LT	\$4192		
	42	96	37	372	38	RET4296-37LT		\$1842	\$2419
	42	84	37	343	34	REV4284-37LT	\$3,954		
	42	84	37	343	34	RET4284-37LT		\$1,737	\$2,282
	42	72	37	313	31	REV4272-37LT	\$3,728		
	42	72	37	313	31	RET4272-37LT		\$1,625	\$2,117
	42	60	37	283	28	REV4260-37LT	\$3,525		
	42	60	37	283	28	RET4260-37LT		\$1,525	\$1,969
	42	54	37	268	26	REV4254-37LT	\$3,435		
	42	54	37	268	26	RET4254-37LT		\$1,481	\$1,906
	36	96	37	322	33	REV3696-37LT	\$3857		
	36	96	37	322	33	RET3696-37LT		\$1694	\$2226
	36	84	37	297	30	REV3684-37LT	\$3,638		
	36	84	37	297	30	RET3684-37LT		\$1,598	\$2,100
	36	72	37	271	27	REV3672-37LT	\$3,429		
	36	72	37	271	27	RET3672-37LT		\$1,496	\$1,948
	36	60	37	245	24	REV3660-37LT	\$3,245		
	36	60	37	245	24	RET3660-37LT		\$1,404	\$1,813
	36	54	37	233	23	REV3654-37LT	\$3,161		
	36	54	37	233	23	RET3654-37LT		\$1,364	\$1,754

- ships KD
- vertical kneespace clearance 31 5/8"
- vertical shelf clearance 2 15/16"
- EC26 worksurface power available, specify "to accommodate worksurface power" on your purchase order; one EC26 unit must be ordered separately, see page 26
- EC27 undersurface power available, see page 26
- wire manager available, see page 25
- optional coat hooks (four hooks), specify and add \$140 list

To Order, Specify:

Veneer

- ① Model Number
- ② Worksurface/Outer Panels Wood Species - Cherry (CH1), Maple (MA1), Walnut (WA1) or Double Cut (DC1) (see page 2)
- ③ Finish Color (see page 2)

- ④ Inner Panels Species & Finish
 - a.) Same as Worksurface/Outer Panels
 - b.) Paint (see page 2)
- ⑤ Other Product Options

Laminate

- ① Model Number
- ② Worksurface Material (see page 3)
 - a.) TFL
 - b.) HPL
- ③ Worksurface/Outer Panels Laminate Color (see page 3)
- ④ Inner Panels Laminate Color
 - a.) Same as Worksurface/Outer Panels
 - b.) Other Laminate (see page 3)
- ⑤ Other Product Options

Description	D	W	H	CTN WT	CU FT	① Model	Veneer Flat Cut and Double Cut List Price	TFL Laminate List Price	HPL Laminate List Price
30" h Layered Table	48	96	30	364	38	REV4896-30LT	\$4178		
	48	96	30	364	38	RET4896-30LT		\$1835	\$2450
	48	84	30	334	34	REV4884-30LT	\$3,941		
	48	84	30	334	34	RET4884-30LT		\$1,731	\$2,311
	48	72	30	303	31	REV4872-30LT	\$3,711		
	48	72	30	303	31	RET4872-30LT		\$1,609	\$2,128
	48	60	30	273	27	REV4860-30LT	\$3,504		
	48	60	30	273	27	RET4860-30LT		\$1,499	\$1,964
	48	54	30	258	26	REV4854-30LT	\$3,413		
	48	54	30	258	26	RET4854-30LT		\$1,452	\$1,890
	42	96	30	334	35	REV4296-30LT	\$3937		
	42	96	30	334	35	RET4296-30LT		\$1739	\$2300
	42	84	30	306	31	REV4284-30LT	\$3,714		
	42	84	30	306	31	RET4284-30LT		\$1,640	\$2,169
	42	72	30	277	28	REV4272-30LT	\$3,498		
	42	72	30	277	28	RET4272-30LT		\$1,524	\$1,997
	42	60	30	249	25	REV4260-30LT	\$3,305		
	42	60	30	249	25	RET4260-30LT		\$1,421	\$1,844
	42	54	30	235	23	REV4254-30LT	\$3,219		
	42	54	30	235	23	RET4254-30LT		\$1,376	\$1,775
	36	96	30	288	30	REV3696-30LT	\$3625		
	36	96	30	288	30	RET3696-30LT		\$1600	\$2116
	36	84	30	264	27	REV3684-30LT	\$3,419		
	36	84	30	264	27	RET3684-30LT		\$1,509	\$1,996
	36	72	30	239	25	REV3672-30LT	\$3,219		
	36	72	30	239	25	RET3672-30LT		\$1,402	\$1,840
	36	60	30	215	22	REV3660-30LT	\$3,041		
	36	60	30	215	22	RET3660-30LT		\$1,308	\$1,697
	36	54	30	203	20	REV3654-30LT	\$2,964		
	36	54	30	203	20	RET3654-30LT		\$1,266	\$1,632

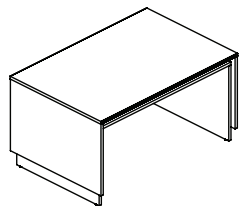

- ships KD
- vertical kneespace clearance 24 5/8"
- vertical shelf clearance 2 15/16"
- EC26 worksurface power available, specify "to accommodate worksurface power" on your purchase order; one EC26 unit must be ordered separately, see page 26
- EC27 undersurface power available, see page 26
- wire manager available, see page 25

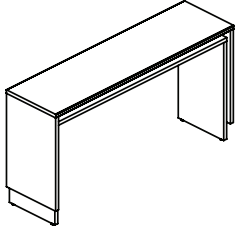
Description	D	W	H	CTN WT	CU FT	① Model	Veneer Flat Cut and Double Cut List Price	TFL Laminate List Price	HPL Laminate List Price
20"d Wall Dependent Layered Table	20	84	42	148	19	REV2084-42LT	\$2,654		
	20	84	42	148	19	RET2084-42LT		\$1,142	\$1,460
	20	72	42	132	17	REV2072-42LT	\$2,516		
	20	72	42	132	17	RET2072-42LT		\$1,082	\$1,371
	20	60	42	116	15	REV2060-42LT	\$2,379		
	20	60	42	116	15	RET2060-42LT		\$1,029	\$1,291
	20	54	42	109	14	REV2054-42LT	\$2,316		
	20	54	42	109	14	RET2054-42LT		\$1,005	\$1,256
	20	84	37	136	17	REV2084-37LT	\$2,513		
	20	84	37	136	17	RET2084-37LT		\$1,055	\$1,367
	20	72	37	121	16	REV2072-37LT	\$2,369		
	20	72	37	121	16	RET2072-37LT		\$988	\$1,268
	20	60	37	107	14	REV2060-37LT	\$2,240		
	20	60	37	107	14	RET2060-37LT		\$928	\$1,180
	20	54	37	100	13	REV2054-37LT	\$2,183		
	20	54	37	100	13	RET2054-37LT		\$901	\$1,142
	20	84	30	125	16	REV2084-30LT	\$2,360		
	20	84	30	125	16	RET2084-30LT		\$997	\$1,299
	20	72	30	111	14	REV2072-30LT	\$2,223		
	20	72	30	111	14	RET2072-30LT		\$926	\$1,197
	20	60	30	97	13	REV2060-30LT	\$2,100		
	20	60	30	97	13	RET2060-30LT		\$864	\$1,105
	20	54	30	86	12	REV2054-30LT	\$2,046		
	20	54	30	86	12	RET2054-30LT		\$837	\$1,061

- ships KD
- intended for use against a wall, does not attach to the wall
- exposed hardware on back side
- vertical shelf clearance 2¹⁵/₁₆"
- EC27 undersurface power available, see page 26
- EC28 edge mount power available, see page 26
- optional foot rail available on 42"h table, specify and add \$416 list
- optional coat hooks (two hooks) available on 42"h and 37"h tables, specify and add \$84 list
- vertical kneespace clearance for 42"h layered table - 36⁵/₈"
- vertical kneespace clearance for 37"h layered table - 31⁵/₈"
- vertical kneespace clearance for 30"h layered table - 24⁵/₈"

To Order, Specify:

Veneer

- ① Model Number
- ② Worksurface/Outer Panels Wood Species - Cherry (CH1), Maple (MA1), Walnut (WA1) or Double Cut (DC1) (see page 2)
- ③ Finish Color (see page 2)

- ④ Inner Panels Species & Finish
 - a.) Same as Worksurface/Outer Panels
 - b.) Paint (see page 2)
- ⑤ Other Product Options

Laminate

- ① Model Number
- ② Worksurface Material (see page 3)
 - a.) TFL
 - b.) HPL
- ③ Worksurface/Outer Panels Laminate Color (see page 3)
- ④ Inner Panels Laminate Color
 - a.) Same as Worksurface/Outer Panels
 - b.) Other Laminate (see page 3)
- ⑤ Other Product Options

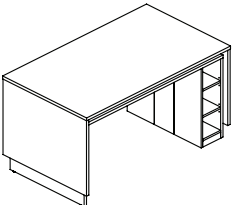
Description	D	W	H	CTN WT	CU FT	① Model	Veneer Flat Cut and Double Cut List Price	TFL Laminate List Price	HPL Laminate List Price
42" h Layered Table with Asymmetric Bookshelf	48	96	42	579	55	REV4896-42LTNB	\$5358		
	48	96	42	579	55	RET4896-42LTNB		\$2435	\$3144
	48	84	42	545	51	REV4884-42LTNB	\$5054		
	48	84	42	545	51	RET4884-42LTNB		\$2297	\$2966
	48	72	42	511	47	REV4872-42LTNB	\$4797		
	48	72	42	511	47	RET4872-42LTNB		\$2177	\$2787
	48	60	42	476	43	REV4860-42LTNB	\$4568		
	48	60	42	476	43	RET4860-42LTNB		\$2071	\$2627
	48	54	42	459	42	REV4854-42LTNB	\$4464		
	48	54	42	459	42	RET4854-42LTNB		\$2023	\$2554
	42	96	42	530	50	REV4296-42LTNB	\$5073		
	42	96	42	530	50	RET4296-42LTNB		\$2302	\$2960
	42	84	42	498	46	REV4284-42LTNB	\$4785		
	42	84	42	498	46	RET4284-42LTNB		\$2171	\$2792
	42	72	42	466	43	REV4272-42LTNB	\$4541		
	42	72	42	466	43	RET4272-42LTNB		\$2057	\$2624
	42	60	42	433	39	REV4260-42LTNB	\$4323		
	42	60	42	433	39	RET4260-42LTNB		\$1956	\$2473
	42	54	42	417	38	REV4254-42LTNB	\$4226		
	42	54	42	417	38	RET4254-42LTNB		\$1912	\$2406
	36	96	42	466	44	REV3696-42LTNB	\$4713		
	36	96	42	466	44	RET3696-42LTNB		\$2129	\$2726
	36	84	42	437	41	REV3684-42LTNB	\$4446		
	36	84	42	437	41	RET3684-42LTNB		\$2008	\$2571
	36	72	42	409	38	REV3672-42LTNB	\$4223		
	36	72	42	409	38	RET3672-42LTNB		\$1904	\$2416
	36	60	42	381	34	REV3660-42LTNB	\$4022		
	36	60	42	381	34	RET3660-42LTNB		\$1811	\$2277
	36	54	42	367	33	REV3654-42LTNB	\$3930		
	36	54	42	367	33	RET3654-42LTNB		\$1770	\$2216

- ships KD
- vertical kneespace clearance 36 5/8"
- vertical shelf clearance 2 15/16"
- adjustable shelves
- removable wire access panel on bookcase side
- EC26 worksurface power available, specify "to accommodate worksurface power" on your purchase order; one EC26 unit must be ordered separately, see page 26
- EC27 undersurface power available, see page 26
- wire manager available on non-bookcase side, see page 25
- optional foot rail (two rails), specify and add \$772 list
- optional coat hooks (four hooks), specify and add \$140 list

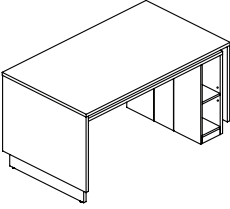
Description	D	W	H	CTN WT	CU FT	① Model	Veneer Flat Cut and Double Cut List Price	TFL Laminate List Price	HPL Laminate List Price
37" h Layered Table with Asymmetric Bookshelf	48	96	37	531	51	REV4896-37LTNB	\$5037		
	48	96	37	531	51	RET4896-37LTNB		\$2289	\$2925
	48	84	37	499	47	REV4884-37LTNB	\$4,751		
	48	84	37	499	47	RET4884-37LTNB		\$2,159	\$2,759
	48	72	37	467	44	REV4872-37LTNB	\$4,511		
	48	72	37	467	44	RET4872-37LTNB		\$2,047	\$2,620
	48	60	37	436	40	REV4860-37LTNB	\$4,295		
	48	60	37	436	40	RET4860-37LTNB		\$1,947	\$2,470
	48	54	37	420	38	REV4854-37LTNB	\$4,197		
	48	54	37	420	38	RET4854-37LTNB		\$1,902	\$2,402
	42	96	37	485	46	REV4296-37LTNB	\$4769		
	42	96	37	485	46	RET4296-37LTNB		\$2164	\$2753
	42	84	37	455	43	REV4284-37LTNB	\$4,499		
	42	84	37	455	43	RET4284-37LTNB		\$2,041	\$2,597
	42	72	37	425	40	REV4272-37LTNB	\$4,269		
	42	72	37	425	40	RET4272-37LTNB		\$1,934	\$2,467
	42	60	37	396	36	REV4260-37LTNB	\$4,065		
	42	60	37	396	36	RET4260-37LTNB		\$1,839	\$2,326
	42	54	37	381	35	REV4254-37LTNB	\$3,972		
	42	54	37	381	35	RET4254-37LTNB		\$1,798	\$2,263
	36	96	37	423	40	REV3696-37LTNB	\$4337		
	36	96	37	423	40	RET3696-37LTNB		\$1959	\$2508
	36	84	37	398	37	REV3684-37LTNB	\$4,091		
	36	84	37	398	37	RET3684-37LTNB		\$1,848	\$2,366
	36	72	37	372	35	REV3672-37LTNB	\$3,885		
	36	72	37	372	35	RET3672-37LTNB		\$1,753	\$2,224
	36	60	37	346	32	REV3660-37LTNB	\$3,701		
	36	60	37	346	32	RET3660-37LTNB		\$1,667	\$2,096
	36	54	37	334	30	REV3654-37LTNB	\$3,617		
	36	54	37	334	30	RET3654-37LTNB		\$1,628	\$2,039

- ships KD
- vertical kneespace clearance 31 5/8"
- vertical shelf clearance 2 15/16"
- adjustable shelf
- removable wire access panel on bookcase side
- EC26 worksurface power available, specify "to accommodate worksurface power" on your purchase order; one EC26 unit must be ordered separately, see page 26
- EC27 undersurface power available, see page 26
- wire manager available on non-bookcase side, see page 25
- optional coat hooks (four hooks), specify and add \$140 list

To Order, Specify:

Veneer

- ① Model Number
- ② Worksurface/Outer Panels Wood Species - Cherry (CH1), Maple (MA1), Walnut (WA1) or Double Cut (DC1) (see page 2)
- ③ Finish Color (see page 2)

- ④ Bookcase /Inner Panels Species & Finish
 - a.) Same as Worksurface/Outer Panels
 - b.) Paint (see page 2)
- ⑤ Other Product Options

Laminate

- ① Model Number
- ② Worksurface Material (see page 3)
 - a.) TFL
 - b.) HPL
- ③ Worksurface/Outer Panels Laminate Color (see page 3)
- ④ Bookcase/Inner Panels Laminate Color
 - a.) Same as Worksurface/Outer Panels
 - b.) Other Laminate (see page 3)
- ⑤ Other Product Options

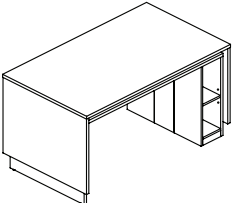
Description	D	W	H	CTN WT	CU FT	① Model	Veneer Flat Cut and Double Cut List Price	TFL Laminate List Price	HPL Laminate List Price
30"h Layered Table with Asymmetric Bookshelf	48	96	30	462	46	REV4896-30LTNB	\$4734		
	48	96	30	462	46	RET4896-30LTNB		\$2152	\$2750
	48	84	30	432	42	REV4884-30LTNB	\$4,466		
	48	84	30	432	42	RET4884-30LTNB		\$2,030	\$2,594
	48	72	30	401	39	REV4872-30LTNB	\$4,241		
	48	72	30	401	39	RET4872-30LTNB		\$1,925	\$2,463
	48	60	30	371	35	REV4860-30LTNB	\$4,038		
	48	60	30	371	35	RET4860-30LTNB		\$1,831	\$2,322
	48	54	30	356	33	REV4854-30LTNB	\$3,947		
	48	54	30	356	33	RET4854-30LTNB		\$1,788	\$2,258
	42	96	30	423	42	REV4296-30LTNB	\$4484		
	42	96	30	423	42	RET4296-30LTNB		\$2035	\$2588
	42	84	30	394	38	REV4284-30LTNB	\$4,230		
	42	84	30	394	38	RET4284-30LTNB		\$1,919	\$2,441
	42	72	30	366	35	REV4272-30LTNB	\$4,014		
	42	72	30	366	35	RET4272-30LTNB		\$1,818	\$2,319
	42	60	30	338	32	REV4260-30LTNB	\$3,822		
	42	60	30	338	32	RET4260-30LTNB		\$1,729	\$2,187
	42	54	30	324	30	REV4254-30LTNB	\$3,735		
	42	54	30	324	30	RET4254-30LTNB		\$1,690	\$2,127
	36	96	30	368	36	REV3696-30LTNB	\$3990		
	36	96	30	368	36	RET3696-30LTNB		\$1802	\$2309
	36	84	30	344	33	REV3684-30LTNB	\$3,764		
	36	84	30	344	33	RET3684-30LTNB		\$1,700	\$2,178
	36	72	30	319	31	REV3672-30LTNB	\$3,575		
	36	72	30	319	31	RET3672-30LTNB		\$1,613	\$2,047
	36	60	30	295	28	REV3660-30LTNB	\$3,405		
	36	60	30	295	28	RET3660-30LTNB		\$1,534	\$1,929
	36	54	30	283	26	REV3654-30LTNB	\$3,329		
	36	54	30	283	26	RET3654-30LTNB		\$1,498	\$1,876

- ships KD
- vertical kneespace clearance 24 5/8"
- vertical shelf clearance 2 15/16"
- adjustable shelf
- removable wire access panel on bookcase side
- EC26 worksurface power available, specify "to accommodate worksurface power" on your purchase order; one EC26 unit must be ordered separately, see page 26
- EC27 undersurface power available, see page 26
- wire manager available on non-bookcase side, see page 25

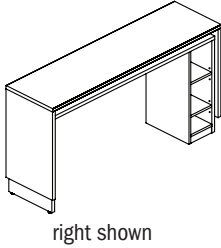
Description	D	W	H	CTN WT	CU FT	① Model	Veneer Flat Cut and Double Cut List Price	TFL Laminate List Price	HPL Laminate List Price
42" h Wall Dependent Layered Table with Asymmetric Bookshelf	20	84	42	209	23	REV2084-42LTNBR	\$3096		
	20	84	42	209	23	RET2084-42LTNBR		\$1418	\$1794
	20	84	42	209	23	REV2084-42LTNBL	\$3096		
	20	84	42	209	23	RET2084-42LTNBL		\$1418	\$1794
	20	72	42	193	22	REV2072-42LTNBR	\$2958		
	20	72	42	193	22	RET2072-42LTNBR		\$1358	\$1705
	20	72	42	193	22	REV2072-42LTNBL	\$2958		
	20	72	42	193	22	RET2072-42LTNBL		\$1358	\$1705
	20	60	42	177	20	REV2060-42LTNBR	\$2822		
	20	60	42	177	20	RET2060-42LTNBR		\$1305	\$1624
	20	60	42	177	20	REV2060-42LTNBL	\$2822		
	20	60	42	177	20	RET2060-42LTNBL		\$1305	\$1624
	20	54	42	169	19	REV2054-42LTNBR	\$2759		
	20	54	42	169	19	RET2054-42LTNBR		\$1281	\$1590
	20	54	42	169	19	REV2054-42LTNBL	\$2759		
	20	54	42	169	19	RET2054-42LTNBL		\$1281	\$1590

- ships KD
- intended for use against a wall, does not attach to the wall
- exposed hardware on back side
- vertical kneespace clearance 36 5/8"
- vertical shelf clearance 2 15/16"
- adjustable shelves
- EC27 undersurface power available, see page 26
- EC28 edge mount power available, see page 26
- optional foot rail, specify and add \$416 list
- optional coat hooks (two hooks), specify and add \$84 list

To Order, Specify:

Veneer

- ① Model Number
- ② Worksurface/Outer Panels Wood Species - Cherry (CH1), Maple (MA1), Walnut (WA1) or Double Cut (DC1) (see page 2)
- ③ Finish Color (see page 2)

- ④ Bookcase /Inner Panels Species & Finish
 - a.) Same as Worksurface/Outer Panels
 - b.) Paint (see page 2)
- ⑤ Other Product Options

Laminate

- ① Model Number
- ② Worksurface Material (see page 3)
 - a.) TFL
 - b.) HPL
- ③ Worksurface/Outer Panels Laminate Color (see page 3)
- ④ Bookcase/Inner Panels Laminate Color
 - a.) Same as Worksurface/Outer Panels
 - b.) Other Laminate (see page 3)
- ⑤ Other Product Options

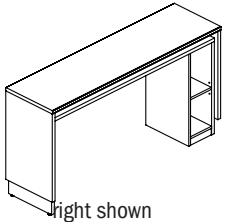
Description	D	W	H	CTN WT	CU FT	① Model	Veneer Flat Cut and Double Cut List Price	TFL Laminate List Price	HPL Laminate List Price
37" h Wall Dependent Layered Table with Asymmetric Bookshelf	20	84	37	191	22	REV2084-37LTNBR	\$2912		
	20	84	37	191	22	RET2084-37LTNBR		\$1334	\$1686
	20	84	37	191	22	REV2084-37LTNBL	\$2912		
	20	84	37	191	22	RET2084-37LTNBL		\$1334	\$1686
	20	72	37	177	20	REV2072-37LTNBR	\$2768		
	20	72	37	177	20	RET2072-37LTNBR		\$1266	\$1588
	20	72	37	177	20	REV2072-37LTNBL	\$2768		
	20	72	37	177	20	RET2072-37LTNBL		\$1266	\$1588
	20	60	37	162	18	REV2060-37LTNBR	\$2639		
	20	60	37	162	18	RET2060-37LTNBR		\$1207	\$1499
	20	60	37	162	18	REV2060-37LTNBL	\$2639		
	20	60	37	162	18	RET2060-37LTNBL		\$1207	\$1499
	20	54	37	155	18	REV2054-37LTNBR	\$2582		
	20	54	37	155	18	RET2054-37LTNBR		\$1180	\$1461
	20	54	37	155	18	REV2054-37LTNBL	\$2582		
	20	54	37	155	18	RET2054-37LTNBL		\$1180	\$1461

- ships KD
- intended for use against a wall, does not attach to the wall
- exposed hardware on back side
- vertical kneespace clearance 31 5/8"
- vertical shelf clearance 2 15/16"
- adjustable shelf
- EC27 undersurface power available, see page 26
- EC28 edge mount power available, see page 26
- optional coat hooks (two hooks), specify and add \$84 list

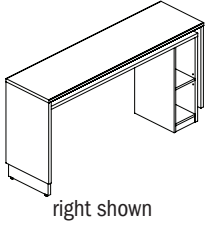
Description	D	W	H	CTN WT	CU FT	① Model	Veneer Flat Cut and Double Cut List Price	TFL Laminate List Price	HPL Laminate List Price
30" h Wall Dependent Layered Table with Asymmetric Bookshelf	20	84	30	169	19	REV2084-30LTNBR	\$2,738		
	20	84	30	169	19	RET2084-30LTNBR		\$1,254	\$1,585
	20	84	30	169	19	REV2084-30LTNBL	\$2,738		
	20	84	30	169	19	RET2084-30LTNBL		\$1,254	\$1,585
	20	72	30	155	18	REV2072-30LTNBR	\$2,601		
	20	72	30	155	18	RET2072-30LTNBR		\$1,183	\$1,483
	20	72	30	155	18	REV2072-30LTNBL	\$2,601		
	20	72	30	155	18	RET2072-30LTNBL		\$1,183	\$1,483
	20	60	30	141	16	REV2060-30LTNBR	\$2,478		
	20	60	30	141	16	RET2060-30LTNBR		\$1,121	\$1,392
	20	60	30	141	16	REV2060-30LTNBL	\$2,478		
	20	60	30	141	16	RET2060-30LTNBL		\$1,121	\$1,392
	20	54	30	134	15	REV2054-30LTNBR	\$2,424		
	20	54	30	134	15	RET2054-30LTNBR		\$1,094	\$1,348
	20	54	30	134	15	REV2054-30LTNBL	\$2,424		
	20	54	30	134	15	RET2054-30LTNBL		\$1,094	\$1,348

- ships KD
- intended for use against a wall, does not attach to the wall
- exposed hardware on back side
- vertical kneespace clearance 24 5/8"
- vertical shelf clearance 2 15/16"
- adjustable shelf
- EC27 undersurface power available, see page 26
- EC28 edge mount power available, see page 26

To Order, Specify:

Veneer

- ① Model Number
- ② Worksurface/Outer Panels Wood Species - Cherry (CH1), Maple (MA1), Walnut (WA1) or Double Cut (DC1) (see page 2)
- ③ Finish Color (see page 2)

- ④ Bookcase /Inner Panels Species & Finish
 - a.) Same as Worksurface/Outer Panels
 - b.) Paint (see page 2)
- ⑤ Other Product Options

Laminate

- ① Model Number
- ② Worksurface Material (see page 3)
 - a.) TFL
 - b.) HPL
- ③ Worksurface/Outer Panels Laminate Color (see page 3)
- ④ Bookcase/Inner Panels Laminate Color
 - a.) Same as Worksurface/Outer Panels
 - b.) Other Laminate (see page 3)
- ⑤ Other Product Options

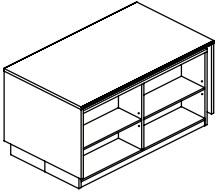
Description	D	W	H	CTN WT	CU FT	① Model	Veneer Flat Cut and Double Cut List Price	TFL Laminate List Price	HPL Laminate List Price
37" h Layered Table with Full Width Bookcases	48	72	37	485	86	REV4872-37LTFB	\$5132		
	48	72	37	485	86	RET4872-37LTFB		\$2192	\$2835
	42	72	37	450	76	REV4272-37LTFB	\$4824		
	42	72	37	450	76	RET4272-37LTFB		\$2061	\$2666

- ships KD
- adjustable shelves
- vertical shelf clearance 2 15/16"

37" h Wall Dependent Layered Table with Full Width Bookcases	20	72	37	232	38	REV2072-37LTFB	\$2,942		
	20	72	37	232	38	RET2072-37LTFB		\$1,262	\$1,608

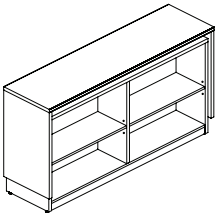

- ships KD
- intended for use against a wall, does not attach to the wall
- exposed hardware on back side
- adjustable shelves
- vertical shelf clearance 2 15/16"

To Order, Specify:

- | | | |
|--|---|--|
| <p>Veneer</p> <ul style="list-style-type: none"> ① Model Number ② Worksurface/Outer Panels Wood Species - Cherry (CH1), Maple (MA1), Walnut (WA1) or Double Cut (DC1) (see page 2) ③ Finish Color (see page 2) | <ul style="list-style-type: none"> ④ Bookcase/Inner Panels Species & Finish <ul style="list-style-type: none"> a.) Same as Worksurface/Outer Panels b.) Paint (see page 2) ⑤ Other Product Options | <p>Laminate</p> <ul style="list-style-type: none"> ① Model Number ② Worksurface Material (see page 3) <ul style="list-style-type: none"> a.) TFL b.) HPL ③ Worksurface/Outer Panels Laminate Color (see page 3) ④ Bookcase/Inner Panels Laminate Color <ul style="list-style-type: none"> a.) Same as Worksurface/Outer Panels b.) Other Laminate (see page 3) ⑤ Other Product Options |
|--|---|--|

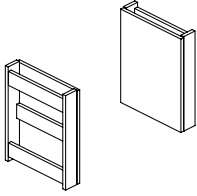
Description	D	W	H	CTN WT	CU FT	① Model	Veneer Flat Cut and Double Cut List Price	Laminate List Price
Vertical Wire Manager 	3 ¾	16	26 ½	18	2	REV1626WMA	\$654	
	3 ¾	16	26 ½	18	2	RET1626WMA		\$285
	3 ¾	10	26 ½	15	2	REV1026WMA	\$633	
	3 ¾	10	26 ½	15	2	RET1026WMA		\$274
	3 ¾	16	20 ½	15	2	REV1620WMA	\$560	
	3 ¾	16	20 ½	15	2	RET1620WMA		\$244
	3 ¾	10	20 ½	12	1	REV1020WMA	\$542	
	3 ¾	10	20 ½	12	1	RET1020WMA		\$233
	3 ¾	16	17 ½	13	2	REV1617WMA	\$531	
	3 ¾	16	17 ½	13	2	RET1617WMA		\$225
	3 ¾	10	17 ½	11	1	REV1017WMA	\$520	
	3 ¾	10	17 ½	11	1	RET1017WMA		\$218

- attaches to non-bookcase end panels
- sold as individual unit (not in pairs)
- see page 7 to determine appropriate vertical wire manager

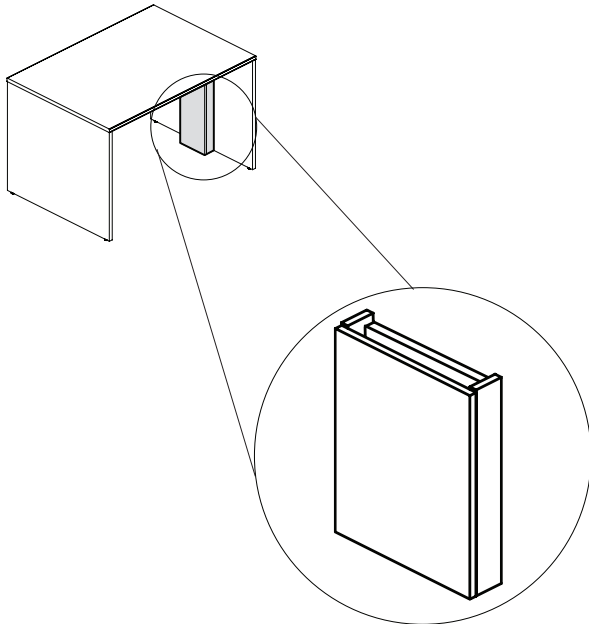

To Order, Specify:

Veneer

- ① Model Number
- ② Wood Species - Cherry (CH1), Maple (MA1), Walnut (WA1), Double Cut (DC1) or Paint (PNT) (see page 2)
- ③ Finish Color (see page 2)

Laminate

- ① Model Number
- ② Laminate Color (see page 3)

Description	D	W	H	CTN WT	CU FT	① Model	List Price
Worksurface Power	2 5/8	6 3/8	3	3	1	EC26	\$500 ▲

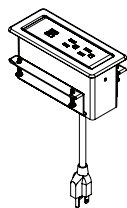

- (2) power receptacles
- (1) dual powered USB
- 120" power cord with molded plug
- White (W) or Black (B) finish available, specify when ordering ▲
- UL recognized
- meets UL spill requirements

Under Surface Power	3 ▲	6 1/2 ▲	1 13/16 ▲	2 ▲	1	EC27	\$475 ▲
---------------------	-----	---------	-----------	-----	---	------	---------

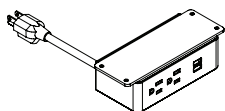

- (2) power receptacles
- (1) dual powered USB
- 120" power cord with molded plug
- White (W) or Black (B) finish available, specify when ordering ▲
- UL recognized

Edge Mount Power	3 1/2 ▲	5 1/2 ▲	7 1/2 ▲	3 ▲	1	EC28	\$475 ▲
------------------	---------	---------	---------	-----	---	------	---------

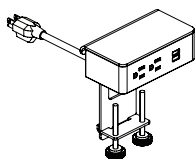

- (2) power receptacles
- (1) dual powered USB
- 72" power cord with molded plug
- White (W) or Black (B) finish available, specify when ordering ▲
- UL recognized

To Order, Specify:

- ① Model Number

Strata Product Information



Strata Product Information

Strata Veneer

Exterior Wood Materials

Exterior surfaces are made from the finest selected veneers to achieve clarity and consistency in the Strata Veneer product line. To attain a pleasing, symmetrical pattern, all cherry, maple and walnut veneers are book-matched. All exterior solid lumber is matched to coordinate with the veneer.

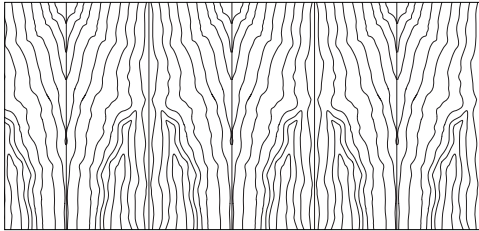

Book-Matched Example

Alternating pieces of veneer are flipped over so they face each other like the pages within a book.

Strata Veneer is available in flat cut cherry, maple and walnut veneer. A wide range of wood stains have been formulated to enhance the beauty of the veneer.

Double Cut veneer is another choice on Strata Veneer product. This veneer is a processed product that has at least two cuttings to create the final veneers. These cuts of veneer strands are dyed and layered into a block to create variation of patterns from a very tight grain pattern to an exotic figure grain pattern. The diagram below shows the tight pattern used on Strata Veneer.

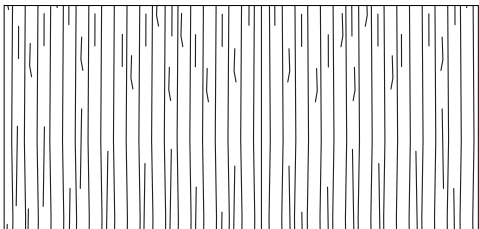

Solid painted finishes on MDF are also offered to provide an accent to the Strata product.

Worksurface Construction

Tops are 5-ply balanced construction, 1 3/16" thick with solid matching hardwood edges. Surfaces are available in wood veneer or high pressure laminate. No additional charge for using our coordinating high pressure laminate with a veneer grain pattern with finish wood edges.

Case Construction

Outside panels are 3/4" and joined together with dowels reinforced with screws, cleats and metal fasteners for increased stability. Leveling glides are set into solid hardwood blocks, which helps to prevent the leveling glide from tear out. Tops are secured to the chassis with top fastening cleats screwed to the inside of the panels.

Drawers

The unidirectional V-Fold drawer box is a durable miter-fold drawer structure which is glued and doweled. The 1/2" thick drawer sides are wrapped in a high grade maple vinyl, with an attached front. The drawer front is attached to the four sided box.

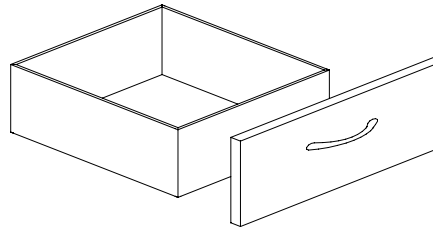

Drawer Suspension

High quality black drawer suspension carries a lifetime warranty. File and box drawers have 100% full extension with over travel. Slides feature steel ball bearings for longer wear and positive, cushioned in/out stops.

Locking

Desk and return pedestals feature pedestal front locking to provide maximum security and flexibility in configuration.

Units are shipped randomly keyed as standard. Key alike units are available upon request for no additional charges. Removable cores for in-field re-keying are standard. product.

Installation

Installation assistance is available, contact Customer Service for a quote.

Strata Product Information

Finish - Stain/Colors

We offer a variety of wood stains and paint colors on Strata. Please see the chart below. Samples are available upon request. Former finish names are listed in parentheses for reference.

CH1 Cherry *Flat Cut Veneer*

AUT Autumn (<i>Autumn Cherry</i>)	EAR Earthy
BRL Barley	LGC Legacy (<i>Legacy Cherry</i>)
BBN Bourbon (<i>Natural Cherry</i>)	PRL Praline (<i>Vintage Cherry</i>)
BRG Brighton (<i>Brighton Cherry</i>)	SAF Saffron (<i>Medium Cherry</i>)
CLA Classic (<i>Classic Cherry</i>)	

MA1 Maple *Flat Cut Veneer*

ALE Ale (<i>Natural Maple</i>)	FLX Flax
BUT Butterscotch	VEN Venetian (<i>Dark Mahogany</i>)
CIN Cinnamon	

WA1 Walnut *Flat Cut Veneer*

AUB Auburn (<i>Windsor Mahogany</i>)	SIE Sienna
ESP Espresso	TOF Toffee
MCH Mocha	TRF Truffle
NTO Night Owl (<i>Vintage Walnut</i>)	

DC1 Double Cut Veneer

COF Coffee	KHK Khaki
CRM Cremello	STU Studio Teak
GRH Graphite	

PNT Paint

BKD Backdrop	GRV Greek Villa
BFX Black Fox	NET Network Gray
BWH Bright White	NWH Nonchalant White
CGP Cargo Pants	STM Storm
CHT Chatroom	TRC Tricorn Black
FRR French Roast	

Protective Top Coat

DuraTex™ offers exceptional hardness along with abrasion and impact resistance, it has been formulated to eliminate hazardous and harmful gases that are normally associated with wood finish.

DuraTex™ Features

Safety - Significantly reduces hazardous formaldehyde emissions which help improve the quality of the indoor air we breathe. **Quality** - Developed to be tough and durable with special attention to appearance. The DuraTex™ finish preserves the natural beauty of wood. **Durability** - Designed to meet a wide range of demanding performance and environmental standards to withstand even the highest wear and tear.

Custom/Special Finishes

JSI, upon request, will accommodate special finishes. A written request is required to proceed with custom finish orders. A sample reference is required for first time matches and must be included with the written request.

There is a one time charge of **\$289 list per order** for any non-standard wood finish.

Orders will be entered noting the special finish. A sample match will be provided to the customer. Written approval is needed before the finish process can be started. Delays in approval may have an impact on lead times.

Every effort will be made to create the requested match; however, an acceptable match may not be possible because of natural variations of wood. These natural variations can also cause minor differences in the final finish product.

Product Modification

Laminate Tops

Worksurface only, no additional upcharge if coordinating wood grain laminate is specified. Contact Customer Service for any other laminate request. Listed below are finishes that have coordinating wood grain HPL laminates.

Cherry Finishes	Maple Finishes	Walnut Finishes
Autumn	Ale	Auburn
Barley	Cinnamon	Mocha
Bourbon	Venetian	Night Owl
Brighton		Sienna
Classic		Toffee
Legacy		Truffle
Praline		
Saffron		

Pedestal Configuration Change

File/File configuration is standard on the reception station.

Strata pedestal drawer configuration can be reconfigured to a Box/Box/File configuration, but must be specified at the time of order; no additional upcharge.

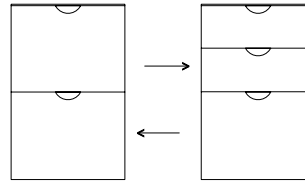

Wood Drawers

Four corner dovetailed wood drawers must be specified at the time of order placement. Specify and add \$200 list per unit.

Strata Product Information

Strata Laminate

Strata Laminate features HPL (high pressure laminate) worksurfaces and TFL (thermally fused laminate) chassis.

Edges of the worksurface are banded with impact resistant (PVC). The laminate is offered in 10 wood grain patterns and 8 solid colors. Wood grain laminates feature an embossed grain that adds texture and helps to hide finger prints and light scratches. The solid color laminates are smooth to the touch with a semi-matte finish. All Strata Laminate products are indoor-air certified by GreenGuard.

The chart below lists the laminates available on the Strata product. Former laminate names are listed in parentheses for reference.

Wood Grain Pattern Laminates

AUT Autumn (<i>Autumn Cherry</i>)	HGL High Line
BLO Blonde Echo	SHE Shea (<i>Nat Maple/Ale finish match</i>)
BBN Bourbon (<i>Natural Cherry</i>)	STU Studio Teak
BZW Brazilwood	WLH Walnut Heights
BRG Brighton (<i>Brighton Cherry</i>)	VIN Vintage (<i>Vintage Cherry</i>)
GRH Graphite	

Solid Laminates

ALB Alabaster	SHD Shadow
BBL Bridal Blanco	SLG Slate Grey
DWH Designer White	TAU Taupe
DOV Dove Grey	

Worksurfaces

Worksurfaces are manufactured with 3-ply balanced construction. Tops are 1 3/16" thick with coordinating PVC edges. Worksurfaces feature 3mm PVC edges on user sides. Edge detail is flat with eased edge on top and bottom. Worksurface ends are banded with 1mm PVC.

HPL Features on Worksurfaces

Fusion of multiple layers creates a higher impact resistant surface. Tops are 3-ply balanced construction. Available in all wood grain and solid patterns.

Case Construction

Panels for chassis consist of a 3/4" thick substrate with TFL surfaces and PVC bands on exposed edges. Pedestals and cabinets are constructed with dowels reinforced with screws, cleats and metal fasteners for increased stability. Leveling glides are set into solid hardwood blocks, which helps to prevent the leveling glide from tear out.

Drawers

The unidirectional V-Fold drawer box is a durable miter-fold drawer structure which is glued and doweled. The 1/2" thick drawer sides are wrapped in a high grade maple vinyl, with an attached front. The drawer front is attached to the four sided box.

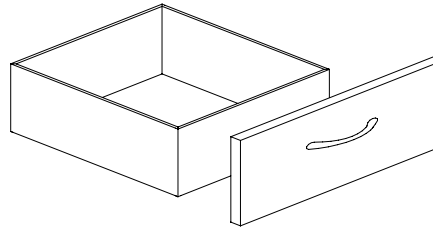

Drawer Suspension

High quality black drawer suspension carries a lifetime warranty. File and box drawers have 100% full extension with over travel. Slides feature steel ball bearings for longer wear and positive, cushioned in/out stops.

Locking

Desk and return pedestals feature pedestal front locking to provide maximum security and flexibility in configuration.

Units are shipped randomly keyed as standard. Key alike units are available upon request for no additional charges. Removable cores for in-field re-keying are standard product.

Installation

Installation assistance is available, contact Customer Service for a quote.

Strata Product Information

Product Modification

Pedestal Configuration Change

File/File configuration is standard on the reception station.

Strata pedestal drawer configuration can be reconfigured to a Box/Box/File configuration, but must be specified at the time of order; no additional upcharge.

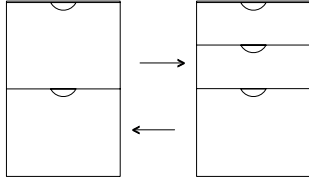

Wood Drawers

Four corner dovetailed wood drawers must be specified at the time of order placement. Specify and add \$200 list per unit.

Strata Product Information

Edge Detail

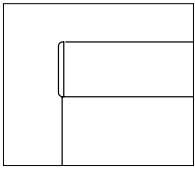

Eased (R3)

Pull Style and Color Options



Arch
Matte Black (MBK)
Matte Silver (MSL)

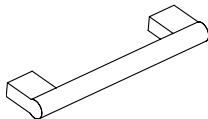

Bar
Matte Black (MBK)
Polished Nickel (PNK)

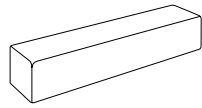

Block
Matte Nickel (MNK)



Bow
Matte Nickel (MNK)



Curve
Matte Nickel (MNK)



Fluent
Matte Black (MBK)
Matte Nickel (MNK)



Healy
Matte Nickel (MNK)



Reveel
Matte Nickel (MNK)



Slotted
Matte Black (MBK)
Matte Nickel (MNK)



Sweep
Matte Black (MBK)
Matte Nickel (MNK)



Twist
Matte Nickel (MNK)

Strata

Strata Product Information

Product Features and Material Options

Flat Cut

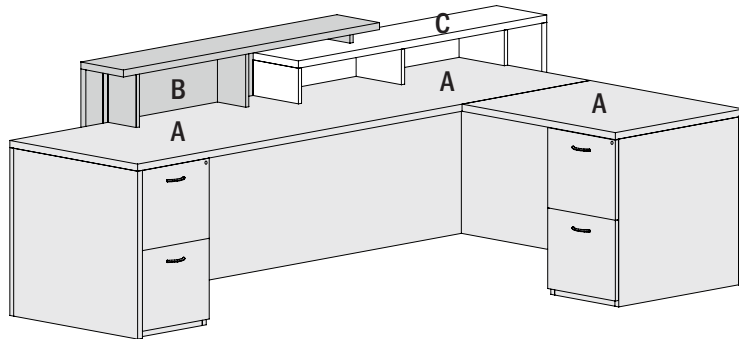

- A Desk/Return**
Flat Cut Veneer
- B Upper Transaction**
Flat Cut Veneer or Paint
- C Lower Transaction**
Flat Cut Veneer or Paint

upper and lower transaction units can be different than the desk/return

upper transaction unit can be different than the lower transaction unit

Double Cut

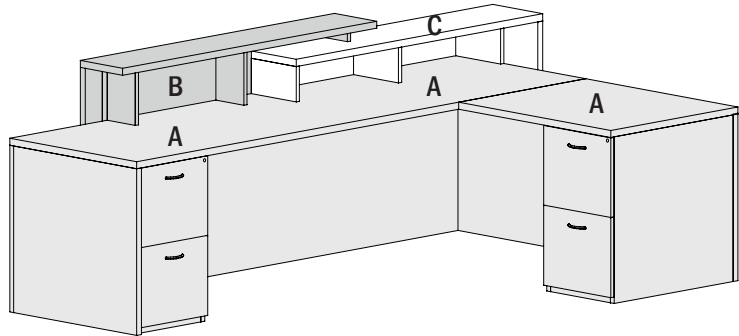

- A Desk/Return**
Double Cut Veneer
- B Upper Transaction**
Double Cut Veneer or Paint
- C Lower Transaction**
Double Cut Veneer or Paint

upper and lower transaction units can be different than the desk/return

upper transaction unit can be different than the lower transaction unit

Laminate

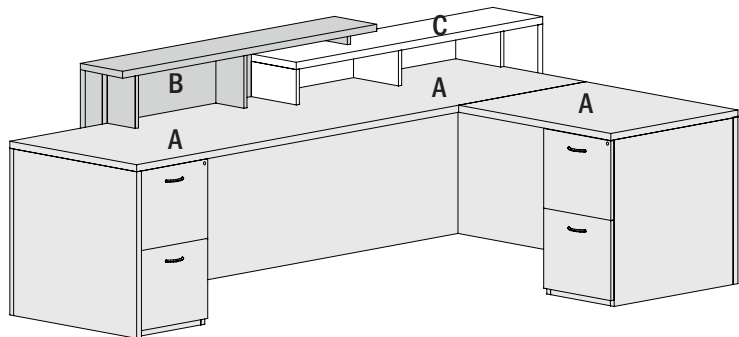

- A Desk/Return**
Laminate
- B Upper Transaction**
Laminate
- C Lower Transaction**
Laminate

upper and lower transaction units can be different than the desk/return

upper transaction unit can be different than the lower transaction unit

Strata Product Information

Flat Cut Veneer Grain Direction

Grain Direction on the worksurface will be long grain. Grain direction on the return worksurface will be short grain.
Grain will run vertical on the chassis of the flat grain veneer units. Grain direction for upper and lower transaction units will run same direction as the desk.

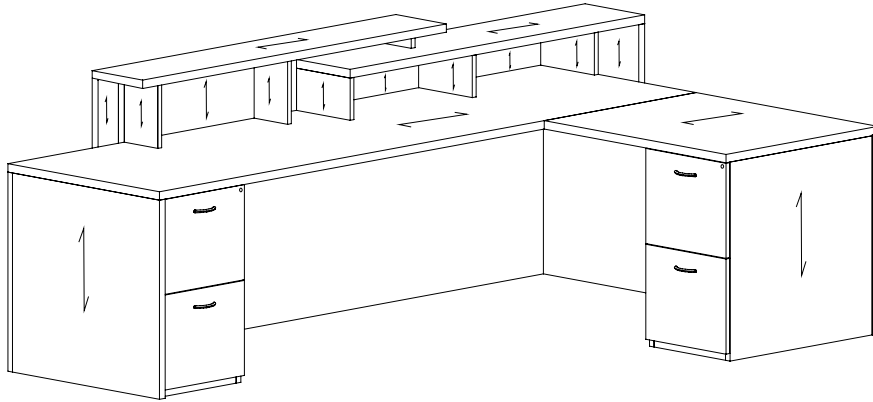

Double Cut Veneer Grain Direction

Grain Direction on the worksurface will be long grain. Grain direction on the return worksurface will be short grain.
Grain will run horizontal on the chassis of the double cut veneer units. Grain direction for upper and lower transaction units will run same direction as the desk.

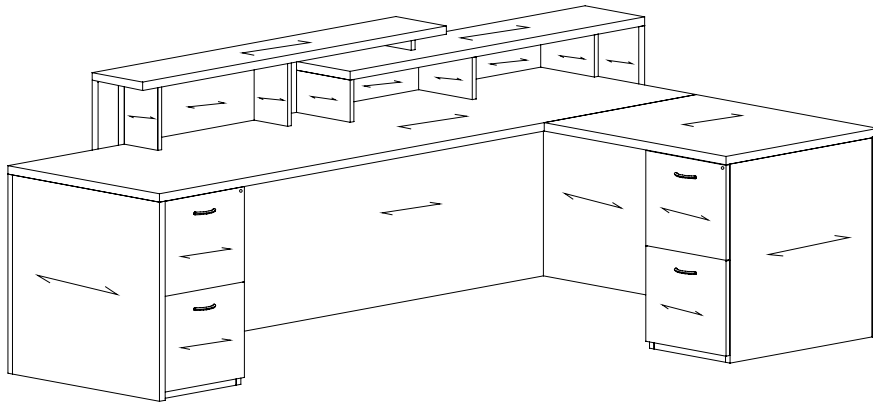

Strata Product Information

Laminate Direction

Grain Direction on the worksurface will be long grain. Grain direction on the return worksurface will be short grain on any unit 60" wide or less. Grain will run horizontal on the chassis of the laminate units. Grain direction for upper and lower transaction units will run same direction as the desk.

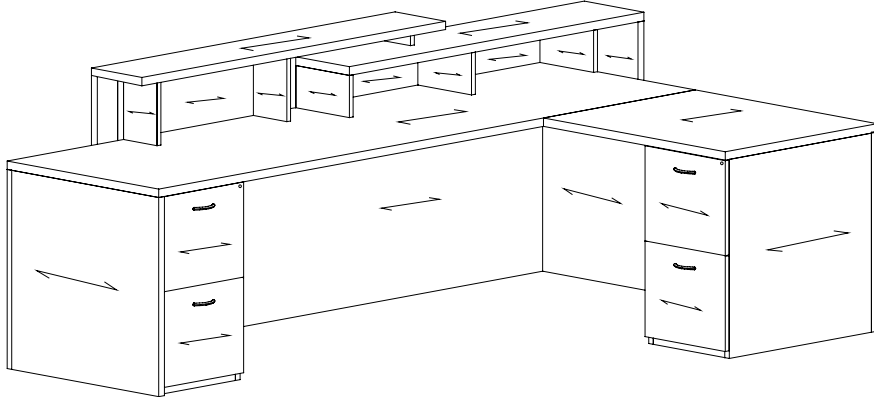

Description	D	W	H	CTN WT	CU FT	① Model	Veneer List Price	Laminate List Price
Right Single Pedestal Desk with Left Return	65 7/8	106	30	618	116	SRV30106RSR	\$34,553	
	65 7/8	106	30	618	116	SRT30106RSR		\$27,625

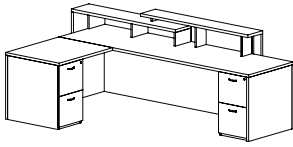

- desk top edge profile user and approach sides
- return top edge profile on user side
- letter width pedestals
- pedestal front locking
- white back painted glass top (40 3/16" x 11 13/16") available for lower transaction shelf; specify and add \$377 list

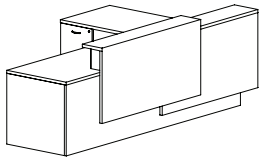

- dimensions:
- desk - 29 7/8" deep
- return - 30" deep x 36" wide
- 5 7/8" vertical clearance of lower transaction unit
- 9" vertical clearance of upper transaction unit
- ships in 4 cartons

To Order, Specify:

- ① Model Number
- ② Desk & Return Wood Species - Cherry (CH1), Maple (MA1), Walnut (WA1) or Double Cut (DC1) (see page 3)
- ③ Finish (see page 3)
- ④ Lower Transaction Wood Species
 - a. Same as Desk & Return
 - b. Cherry (CH1), Maple (MA1), Walnut (WA1), Double Cut (DC1) or Paint (PNT)
 1. Finish or Paint Color (see page 3)
- ⑤ Upper Transaction Wood Species
 - a. Same as Desk & Return
 - b. Same as Lower Transaction
 - c. Cherry (CH1), Maple (MA1), Walnut (WA1), Double Cut (DC1) or Paint (PNT)
 1. Finish or Paint Color (see page 3)
- ⑥ Pull Option & Color (see page 6)
- ⑦ Product Modifications (see page 3)

Note: Reception station must be specified in all flat cut veneer or all double cut veneer. Cannot mix the two veneer types.

Description	D	W	H	CTN WT	CU FT	① Model	Veneer List Price	Laminate List Price
Left Single Pedestal Desk with Right Return	65 7/8	106	30	618	116	SRV30106RSL	\$34,553	
	65 7/8	106	30	618	116	SRT30106RSL		\$27,625

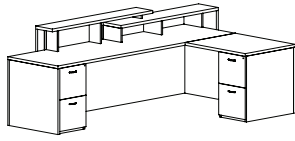

- desk top edge profile user and approach sides
- return top edge profile on user side
- letter width pedestals
- pedestal front locking
- white back painted glass top (40 3/16" x 11 13/16") available for lower transaction shelf; specify and add \$377 list
- dimensions:
- desk - 29 7/8" deep
- return - 30" deep x 36" wide
- 5 7/8" vertical clearance of lower transaction unit
- 9" vertical clearance of upper transaction unit ships in 4 cartons

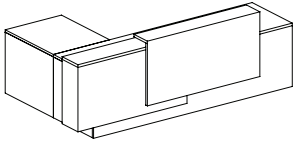

To Order, Specify:

- ① Model Number
- ② Desk & Return Wood Species - Cherry (CH1), Maple (MA1), Walnut (WA1) or Double Cut (DC1) (see page 3)
- ③ Finish (see page 3)
- ④ Lower Transaction Wood Species
 - a. Same as Desk & Return
 - b. Cherry (CH1), Maple (MA1), Walnut (WA1), Double Cut (DC1) or Paint (PNT)
 1. Finish or Paint Color (see page 3)
- ⑤ Upper Transaction Wood Species
 - a. Same as Desk & Return
 - b. Same as Lower Transaction
 - c. Cherry (CH1), Maple (MA1), Walnut (WA1), Double Cut (DC1) or Paint (PNT)
 1. Finish or Paint Color (see page 3)
- ⑥ Pull Option & Color (see page 6)
- ⑦ Product Modifications (see page 3)

Note: Reception station must be specified in all flat cut veneer or all double cut veneer. Cannot mix the two veneer types.